

**CWJ**

Ultra Practice Bundle PDF for All Bank Prelims Exams

Grand Bundle PDF Course 2021



Exams Covered:

SBI Clerk | SBI PO | IBPS RRB PO |
IBPS RRB Clerk | IBPS PO | IBPS Clerk



Separate PDF Course for All Major Bank **Pre + Mains** Exams

- Total No.of Ques : **40,000+**
- Questions in **English**
- Provides you **50 days Study Planner** for each exams
- **Covers all types** of questions in each topic
- Questions in **Exact Exam Level**
- All Our PDFs are **Downloadable**
- **100% Satisfaction Assured** & It's Worthy for your money

Grab it Now

Reasoning Topics

1.Linear Seating Arrangement

Directions (1-5): Study the information carefully and answer the questions given below.

There are eleven people A, B, C, D, E, F, G, H, I, J and K sitting in a straight line facing South direction but not necessarily in the same order. Two People sits between G and E. I sit five places away from J. I and J are not immediate neighbor of G. C and D are not immediate

neighbours. Three persons sit between Both H and G and H and D. F sits to the left of H. Four persons sits between K and F. E sits to the right of H. B sits at the right end of the row. H sits five places away from B.

1. Which of the following people are sitting fifth to the Left of K?

(a) C

Ultra Practice Bundle PDF for All Bank Prelims Exams

- (b) H
- (c) D
- (d) F
- (e) None of these

2. Which of the following statements is true in the context of the above sitting arrangement?

- (a) There are three students sitting between D and C
- (b) K is between I and J.
- (c) C is sitting between F and H.
- (d) K and I are immediate neighbours of G.
- (e) None of these

3. Which of the following groups of friends is sitting to the right of E?

- (a) GK
- (b) AE
- (c) DC
- (d) CH
- (e) None of these

4. Who is sitting in the middle of the row?

- (a) G
- (b) E
- (c) C
- (d) J
- (e) H

5. How many person sits between I and D?

- (a) 1
- (b) 2
- (c) 3
- (d) 4
- (e) Cannot be determined

Directions (6-10): Study the information carefully and answer the questions given below:

Eight persons E, F, G, H, I, K, J and L are sitting in the linear line row facing west. N sits 2nd to the right of H who is immediate to K. Either F or G sit at any of the extreme ends. H and L are immediate neighbours to each other. Number of person between H and I is one more than the number of person between H and L. L sits 2nd to left of J. H is third from any end of the row.

6. How many persons sitting between I and J?

- (a) Four
- (b) Five
- (c) Three
- (d) Two
- (e) Six

7. Who sits second to the left of G?

- (a) N
- (b) J
- (c) Either (a) or (b)
- (d) K
- (e) I

8. Four of the following five are alike in a certain way and hence form a group, which of the following does not belong to the group?

- (a) I, K
- (b) H, L
- (c) N, J
- (d) G, N
- (e) G, F

9. How many persons sit to the left of J?

- (a) Five
- (b) None
- (c) Three

Ultra Practice Bundle PDF for All Bank Prelims Exams

- (d) Two
- (e) One

10. Which of the following is true?

- (a) No one sits to the left of K
- (b) H sits second to the right of N
- (c) G is sitting extreme end of the line.
- (d) I is sitting extreme end of the line.
- (e) Both (c) and (d) are true

Directions (11-15): Study the information carefully and answer the questions given below:

Ten persons are sitting in a row facing north. Less than two persons sit to the left of J. Two persons sit between J and E. A is an immediate neighbour of E. As many persons sits to the right of A sits to the left of H. less than five persons sit between J and H. I sit immediate right of H. W and O are immediate neighbour. As many persons sits to the left of N sits to the right of W. S sits fifth to the left of K.

11. Find the position of K from right end of the row?

- (a) Fourth to the right
- (b) Fourth to the left
- (c) Second to the right
- (d) Second to the left
- (e) Third to the right

12. Which two persons are sitting at the corner?

- (a) N, S
- (b) A, H
- (c) J, O
- (d) A, H
- (e) S, E

13. How many person sits between N and W?

- (a) 1
- (b) 6
- (c) 3
- (d) 4
- (e) 5

14. Who is sitting third to the left of S?

- (a) J
- (b) N
- (c) No One
- (d) A
- (e) E

15. What is the position of W with respect to E?

- (a) Fourth to the right
- (b) Sixth to the left
- (c) Second to the right
- (d) CND
- (e) None of these

Directions (16-20): Study the information carefully and answer the questions given below

Ten persons are sitting in a row some are facing north while some are facing south. P sits fourth to the left of Q and sits one of the extreme ends of the row. More than three persons are sitting between R and Q. S sits third to the right of T and is an immediate neighbour of R, both are facing same direction. U sits fourth to the right of the one who sits immediate left of S. V sits fourth to the left of the one who sits second to the right of W who is not an immediate neighbour of S. Both V and P facing same direction to each other. X sits fourth to the left of Y, both are facing opposite direction. Persons who sit at extreme

Ultra Practice Bundle PDF for All Bank Prelims Exams

ends faces opposite directions. R does not face south. U and X facing same direction.

16. Who is sitting to the immediate right of V?

- (a) T
- (b) U
- (c) Y
- (d) P
- (e) Q

17. If all are made to sit alphabetically from right to left, then position of how many will remain same?

- (a) One
- (b) Two
- (c) Three
- (d) More than three
- (e) None

18. What if the position of U with respect to S?

- (a) Third to the right
- (b) Immediate right
- (c) Fifth to the left
- (d) Second to the left
- (e) Third to the left

19. How many people are facing north direction?

- (a) One
- (b) Two
- (c) Four
- (d) More than four
- (e) Three

20. In which of the following pair all person facing south direction?

- (a) WQU
- (b) YVS
- (c) TSR

- (d) PXU
- (e) XUQ

Directions (21-25): Study the information carefully and answer the questions given below

Eight persons I, J, K, L, M, N, O and P are seating in a row, some are facing north and some are facing south but not necessarily in the same order. I sit third to the right of K and I do not sit at any end of the row. N sits two places away from P. No one sits to the right of N. As many persons sit to the right of I as sit to the left of J who does not faces south. P doesn't face north. M sits second to the right of the one who sits third to the left of O. M is not an immediate neighbor of O. M and L face opposite direction with respect to each other. L faces same direction as P faces.

21. How many persons sit between O and P?

- (a) Three
- (b) Four
- (c) Five
- (d) Two
- (e) Six

22. I sits to the immediate right of?

- (a) J
- (b) L
- (c) Both J and L
- (d) M
- (e) No one

23. How many persons facing south direction?

- (a) 5
- (b) 4
- (c) 2

Ultra Practice Bundle PDF for All Bank Prelims Exams

- (d) 3
- (e) 1

24. Which of the following statement is false?

- (a) I sits immediate left of J
- (b) P and O faces the opposite direction
- (c) M do not sits at the end of the line
- (d) L sits third to the right of P
- (e) There are three persons between K and J

25. Which of the following statement is true?

- (a) L and I faces the same direction
- (b) M is the immediate neighbour of I and J
- (c) J sits third to the left of N
- (d) K faces south direction
- (e) O sits second to the right of I

Directions (26-30): Study the following information to answer the given questions

Twelve people are sitting in two parallel rows containing six people each in such a way that there is an equal distance between adjacent persons. In row 1 – G, H, I, J, K and L are seated (but not necessarily in the same order) and all of them are facing south. In row 2 – C, D, R, T, V and W are seated (but not necessarily in the same order) and all of them are facing North. Therefore in the given seating arrangement each member seated in a row faces another member of the other row. T sits fourth to the right of C. The one facing C sits third to the right of K. Only one person sits between K and G. The one facing L sits second to the Left of D. L does not sit at any of the extreme ends of the line. Only two people sit between D and W. The one facing D sits second to the right of J. H is not an

immediate neighbour of L. R is not immediate neighbour of T.

26. Which of the following groups of people represents the people sitting at extreme ends of both the rows?

- (a) I, J, W, T
- (b) C, R, L, G
- (c) D, H, J, T
- (d) C, V, L, K
- (e) I, W, G, R

27. Who amongst the following faces, K?

- (a) W
- (b) C
- (c) R
- (d) D
- (e) V

28. Which of the following is true with respect to the given information?

- (a) L faces one of the immediate neighbours of D
- (b) L sits exactly between G and H.
- (c) None of the given options is true
- (d) G is an immediate neighbour of K
- (e) T faces J.

29. Which of the following is true regarding H?

- (a) H sits second to the right of L.
- (b) C is an immediate neighbour of the person who faces H
- (c) Both G and K are immediate neighbours of H
- (d) Only one person sits between H and I
- (e) None of the given options is true

Ultra Practice Bundle PDF for All Bank Prelims Exams

30. Who amongst the following sits second to the right of the person who faces V?

- (a) H
- (b) L
- (c) I
- (d) G
- (e) J

Direction (31-35): Study the following information carefully and answer the given questions:

Fourteen persons are sitting in two parallel rows such that seven persons are sitting in each row. H, I, J, K, L, M and N are sitting in row-2 facing south while G, F, E, D, C, B and A are sitting in row-1 facing north. Persons sitting in Row-1 were facing the persons sitting in Row-2. N sits third to the right of H and neither of them sits at an extreme end of the row. The one faces H sits immediate left to C. Only one person sits between C and F. The one who faces F sits third to the left of L. D sits to the immediate right of A. D neither faces N nor L. K is an immediate neighbour of the one who faces D. The one who faces J sits fifth to the right of G. I sits fourth to the right of M. B sits at one of position to the left of E.

31. Four of the following are alike in a certain way so form a group which of the following does not belong to that group?

- (a) L
- (b) M
- (c) A
- (d) G

(e) E

32. How many person sits between F and C?

- (a) Two
- (b) One
- (c) None
- (d) Three
- (e) More than three

33. Which of the following is true regarding I?

- (a) No one sits to the right of I
- (b) I sits third to the right of L
- (c) M is an immediate neighbour of I.
- (d) F is an immediate neighbour of the one who faces I
- (e) Only two persons sit between I and H

34. What is the position of B with respect to D?

- (a) Second to the left
- (b) Third to the right
- (c) Immediate right
- (d) Immediate left
- (e) Second to the right

35. What is the position of G with respect to F?

- (a) Third to the left
- (b) Second to the left
- (c) Forth to the left
- (d) Third to the right
- (e) Fifth to the right

Ultra Practice Bundle PDF for All Bank Prelims Exams

Direction (36-40): Study the following information carefully and answer the given questions:

Nine persons A, B, C, D, E, G, H and I are sitting in the three parallel rows, but not necessarily in the same order. All are facing south. Three persons are sitting in each row. Row 1 is south of Row 2 and Row 2 is south of Row 3. Ahead and behind means immediately as per arrow direction on same line. H sits second to the right of C. G is ahead H. Only one person's sitting between E and A. B sits ahead D. Both D and B are not the immediate neighbors of E. F sits ahead of one who immediate right of I. F sits right of E.

36. Which of the following person sits in row 3?

- (a) G
- (b)
- (c) I
- (d) F
- (e) D
- (f) E

37. Who is immediate left of A?

- (a) E
- (b) G
- (c) B
- (d) I
- (e) F

38. How many persons ahead of B?

- (a) 3
- (b) 2
- (c) 1
- (d) 4
- (e) 5

39. Who among the following is immediate neighbour of D?

- (a) H
- (b) C
- (c) B
- (d) Both (a) and (b)
- (e) G

40. Who is immediate right of G?

- (a) No one
- (b) B
- (c) I
- (d) A
- (e) F

Direction (41-45): Study the following information carefully and answer the given questions:

Twelve persons sit in two parallel rows. Seven seats are in each row. There is one vacant seat in each row. In row 2, A, B, C, D, E and H are sitting and facing north while in row 1, N, I, J, U, O and T are sitting and facing south. Seats of Row-1 face the seats of Row-2. J sits at one of the extreme end. Only one person sits between J and the vacant seat. Two persons sit between D and the vacant seat. The one who faces E sits second to the left of T. J does not face C. The one who faces A sits third to the right of N, who does not sit at any of the extreme end. The one who faces vacant seat sit second to the left of D. As many persons sit to the right of H sit to the right of I. Three persons sit between E and C. Only one person sits between O and the one faces B.

41. How many person sits between vacant seat of row 1 and I.

- (a) 0

Ultra Practice Bundle PDF for All Bank Prelims Exams

- (b) 3
- (c) 2
- (d) 4
- (e) 5

42. How many persons sit between E and the one who faces I.

- (a) 4
- (b) 3
- (c) 2
- (d) 1
- (e) 5

43. Which of the following statement is true regarding C?

- (a) C faces I
- (b) C and D are immediate neighbor.
- (c) Vacant seat faces C
- (d) J sits 3rd left to the one who faces C
- (e) none of these

44. Which of the following faces D?

- (a) O
- (b) I
- (c) J
- (d) T
- (e) none of these

45. Four of the following belongs to a group based on their seating arrangement find the one that does not belong to that group?

- (a) J
- (b) U
- (c) E
- (d) N
- (e) A

Direction (46-50): Study the following information carefully and answer the given questions:

Ten persons F, G, H, I, J, U, V, W, X and Y are sitting in a parallel row such that all are facing south. Persons from U to Y are in 2nd row while rest is in 1st row. The persons in 2nd row are facing back of persons in 1st row. X sits third to the right of W and sits opposite to J. F sits second to the right of I. U sits to the immediate right of Y. F does not sit opposite to V. G sits opposite to neither V nor X. There is at most one person between H and G. H and F are not neighbours.

46. Who among the following person diagonally sits?

- (a) U, G
- (b) W, I
- (c) X, H
- (d) V, F
- (e) Y, G

47. Who among the following sits extreme end of the row?

- (a) F
- (b) I
- (c) U
- (d) J
- (e) W

48. Who sits second to the left of the one who is opposite to U?

- (a) F
- (b) I

Ultra Practice Bundle PDF for All Bank Prelims Exams

- (c) G
- (d) H
- (e) J

49. How many persons sit between X and the one who faces I?

- (a) 2
- (b) 1
- (c) 3
- (d) None

- (e) None of these

50. Who sits second to the left of W?

- (a) Y
- (b) U
- (c) X
- (d) V
- (e) No one

Solution with Explanation

SOLUTION (1-5):

All the person are faces South

1. B sits at the right end of the row.
2. H sits five places away from B.
3. Three persons sit between Both H and G and H and D.

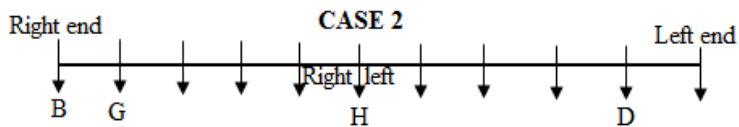
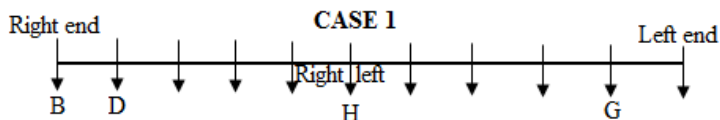

4. Two People sits between G and E.
5. I sit five places away from J.
6. I and J are not immediate neighbor of G.
7. E sits to the right of H

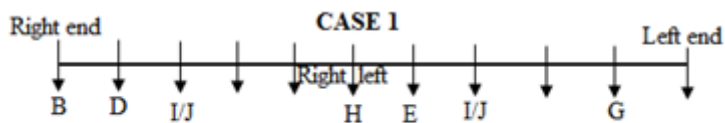

This case is eliminated as it not follows condition number 7

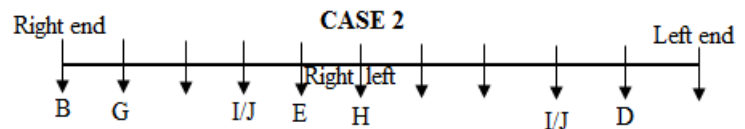

8. F sits to the left of H.
9. Four persons sit between K and F.
10. C and D are not immediate neighbours.

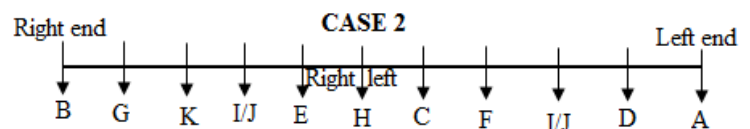

Final Arrangement

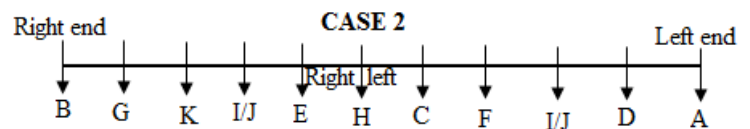

- 1.d
- 2.c
- 3.a
- 4.e
- 5.e

SOLUTION (6-10):



Ultra Practice Bundle PDF for All Bank Prelims Exams

All the person are faces West

- H is third from any end of the row
- N sits 2nd to the right of H who is immediate to K
- H and L are immediate neighbours to each other

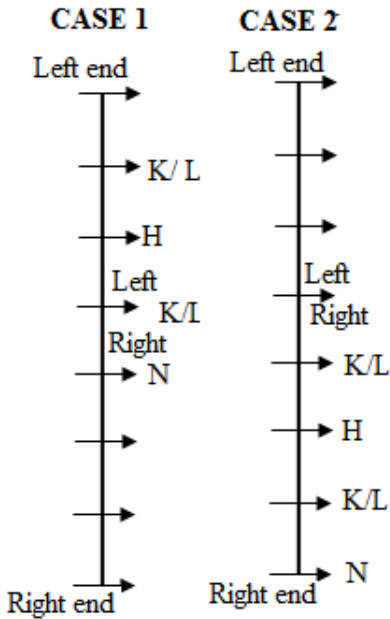

- L sits 2nd to left of J.

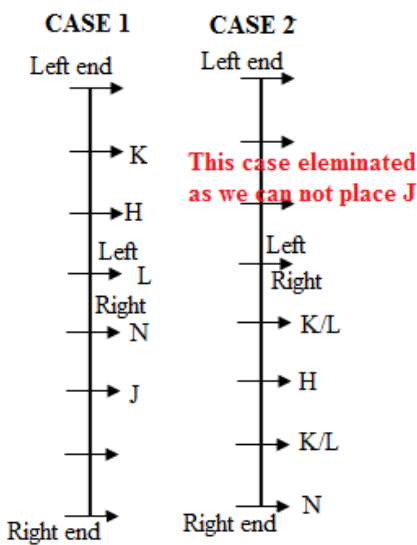

- Number of person between H and I is one more than the number of person between H and L.

- Either F or G sits at any of the extreme ends.

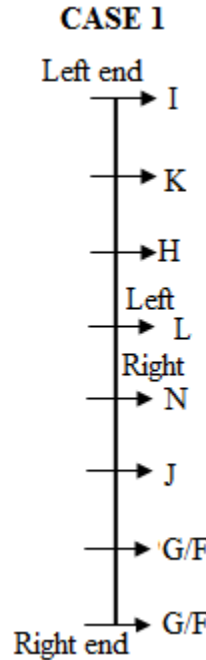

Final Arrangement

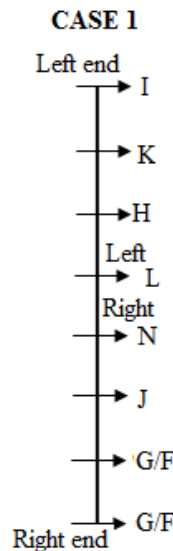

6.a

7.c

8.d (not immediate neighbour)

Ultra Practice Bundle PDF for All Bank Prelims Exams

9.a

10.d

SOLUTION (11-15):

All the person are faces North

- Less than two persons sit to the left of J.
- Two persons sit between J and E.

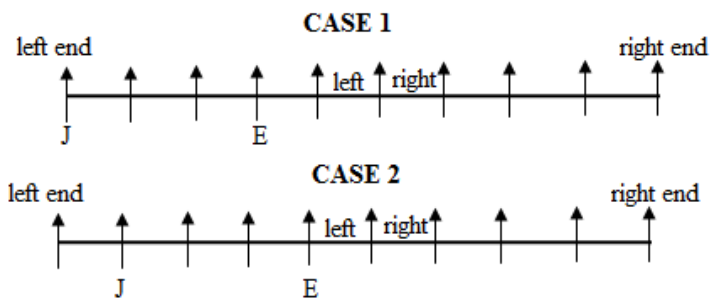

- A is an immediate neighbour of E.
- As many persons sits to the right of A sits to the left of H.
- Less than five persons sit between J and H.

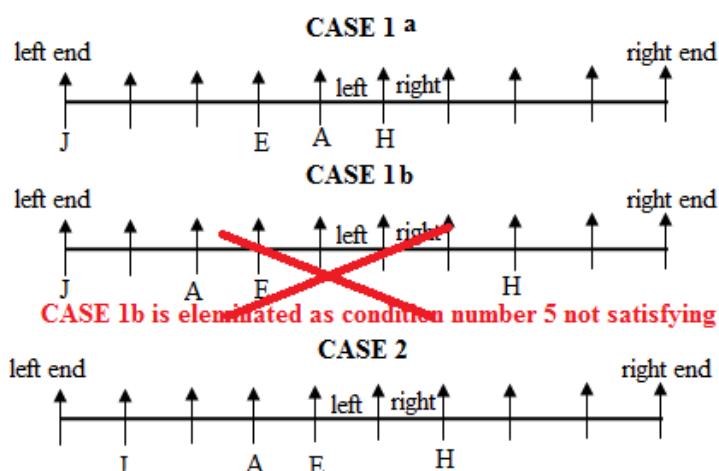

- I sit immediate right of H.
- S sits fifth to the left of K.
- W and O is immediate neighbour.
- As many persons sits to the left of N sits to the right of W

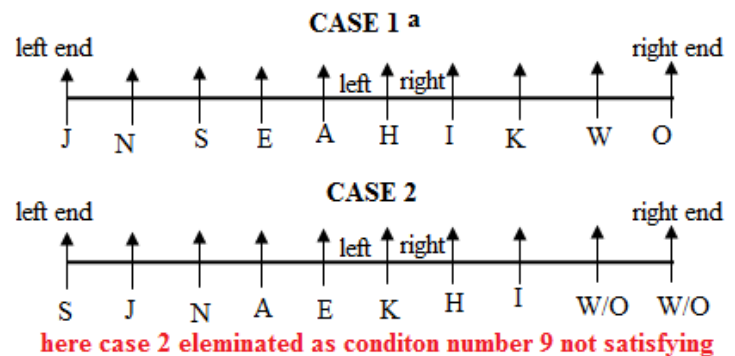

Final Arrangement

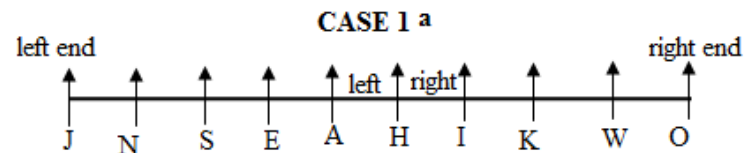

- 11.e
- 12.c
- 13.b
- 14.c
- 15.e

SOLUTION (16-20):

Some are facing north some facing south

- P sits fourth to the left of Q and sits one of the extreme ends of the row.(here Q faces either north or south direction)



Ultra Practice Bundle PDF for All Bank Prelims Exams

- 2. More than three persons are sitting between R and Q.
- 3. S sits third to the right of T and is an immediate neighbour of R. (here T faces either north or south direction)

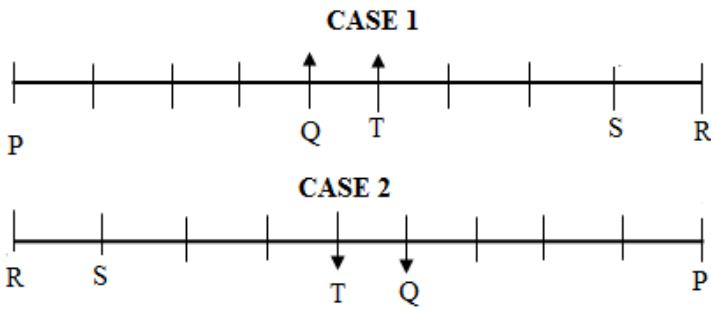

- 4. U sits fourth to the right of the one who sits immediate left of S (here S faces either north or south direction)
- 5. R and S faces same direction. (means they both faces either north or south)
- 6. Persons who sit at extreme ends faces opposite directions.(means if one end faces North the other end faces South)
- 7. R does not face south.(means R faces north)

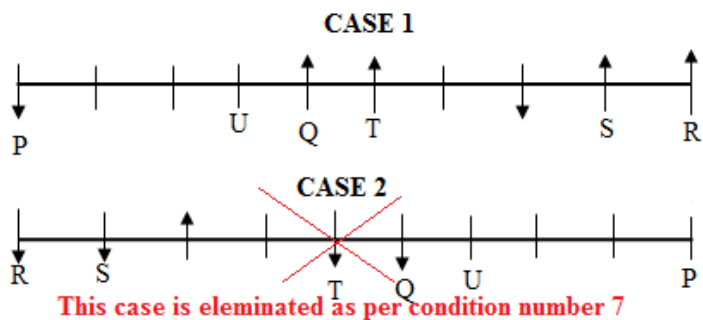

- 8. X sits fourth to the left of Y, both are facing opposite direction. (Means if X faces north then Y faces south)
- 9. U and X facing same direction. .(means they both faces either north or south)

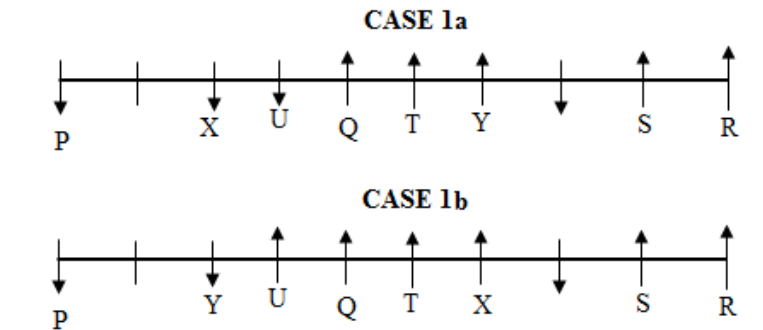

- 10. V sits fourth to the left of the one who sits second to the right of W who is not an immediate neighbour of S.
- 11. Both V and P facing same direction to each other.

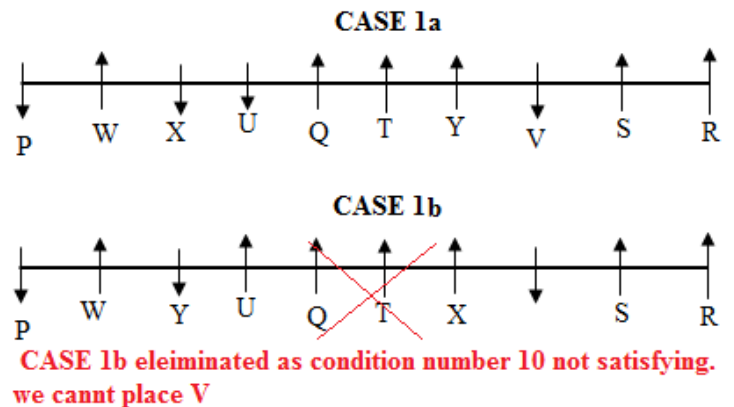

Final Arrangement

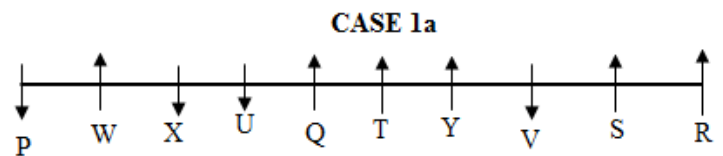

- 16.c
- 17.a
- 18.c
- 19.d
- 20.d



Ultra Practice Bundle PDF for All Bank Prelims Exams

SOLUTION (21-25):

Some are facing north some facing south

1. N sits two places away from P.
2. No one sits to the right of N.
3. P doesn't face north.

CASE 1

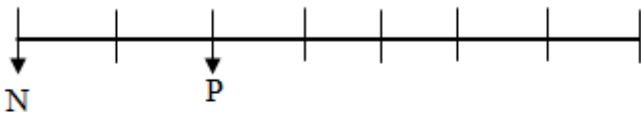

CASE 2

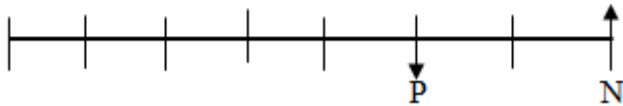

4. M sits second to the right of the one who sits third to the left of O.
5. M is not an immediate neighbor of O.
6. I sit third to the right of K and I do not sit at any end of the row

Here so many cases are possible for O but in all other cases M and O always sits together.

CASE 1 a

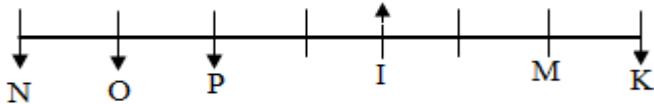

CASE 1 b

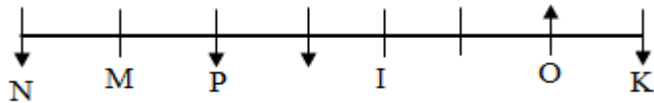

7. As many persons sit to the right of I as sit to the left of J who does not faces south.

CASE 1 a

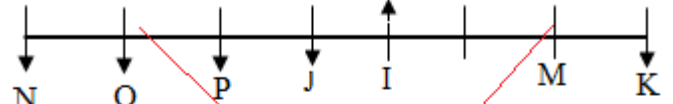

CASE 1 b

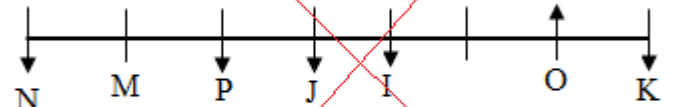

CASE 2 a



ALL THE ABOVE CASE ARE ELEMENATED AS J FACES SOUTH BUT IT IS NOT POSSIBLE AS PER CONDITION NUMBER 7

8. M and L face opposite direction with respect to each other.
9. L faces same direction as P faces.

CASE 2 b



L faces South direction because P faces south but M faces north direction as per condition number 8



Ultra Practice Bundle PDF for All Bank Prelims Exams

Final Arrangement

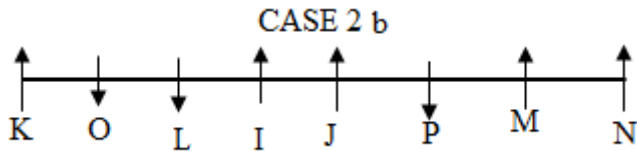

21.a

22.e

23.d

24.b

25.c

SOLUTION (26-30):

1. T sits fourth to the right of C
2. The one facing C sits third to the right of K.

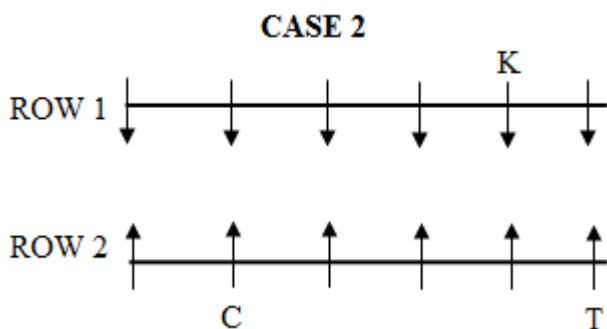
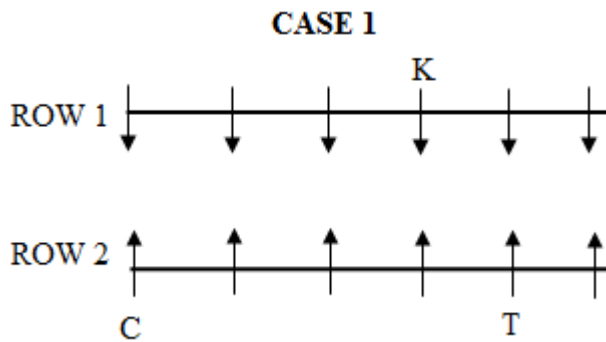

3. Only one person sits between K and G
4. The one facing L sits second to the Left of D.
5. L does not sit at any of the extreme ends of the line.

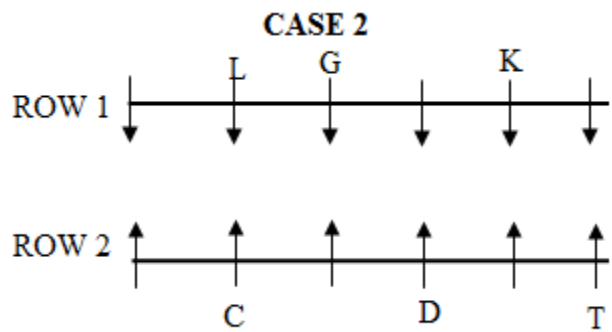
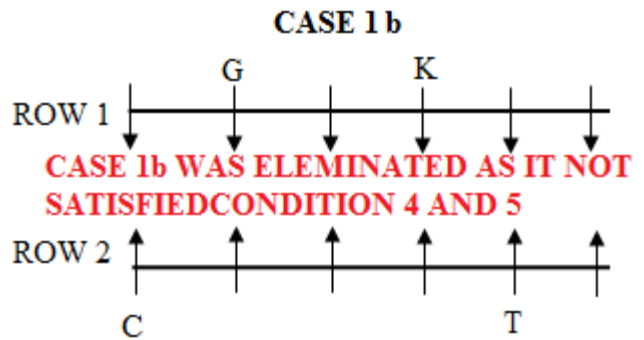
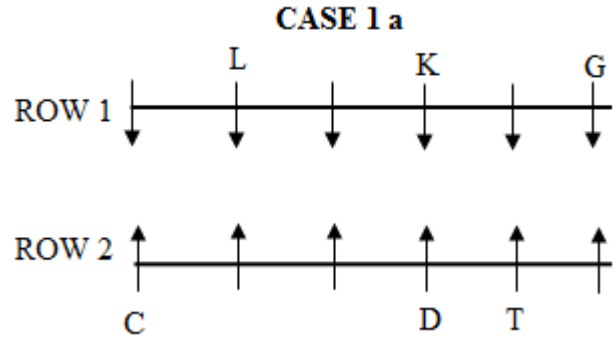

6. Only two people sit between D and W.
7. The one facing D sits second to the right of J.



Ultra Practice Bundle PDF for All Bank Prelims Exams

CASE 1 a

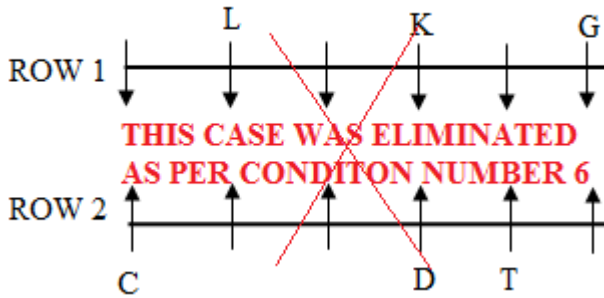

CASE 2

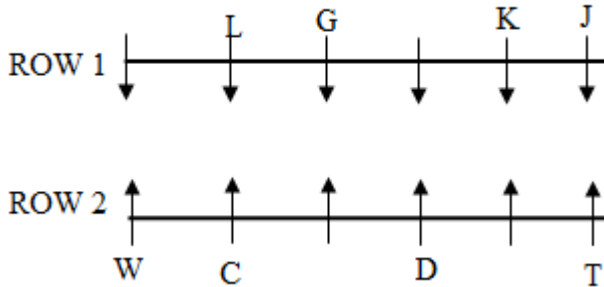

- 8. H is not an immediate neighbour of L.
- 9. R is not immediate neighbour of T.

CASE 2

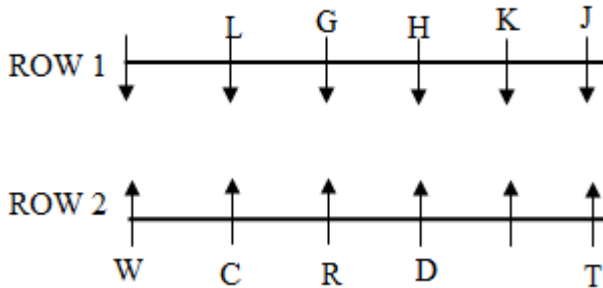

Final Arrangement

CASE 2

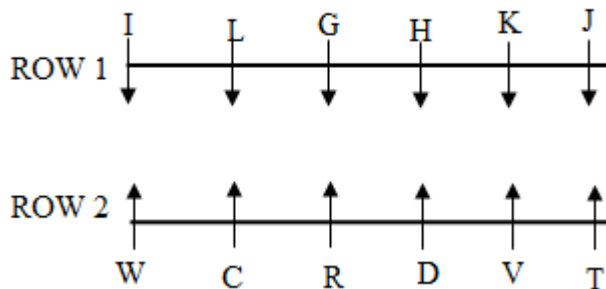

26.a

27.e

28.e

29.c

30.d

SOLUTION (31-35):

1. N sits third to the right of H and neither of them sits at an extreme end of the row.
2. The one faces H sits immediate left to C.
3. Only one person sits between C and F.
4. The one who faces F sits third to the left of L.

CASE 1

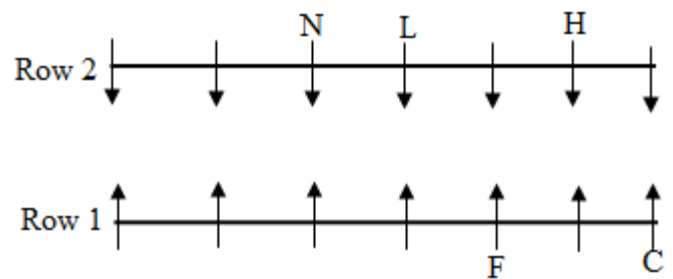

CASE 2

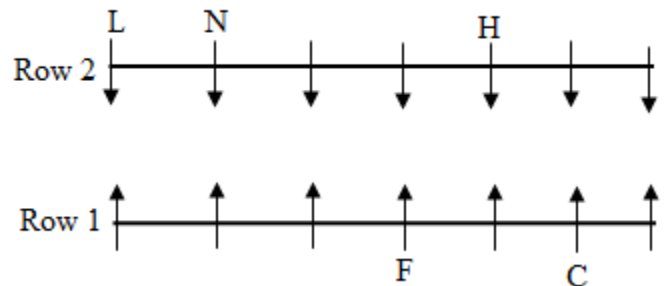

5. D sits to the immediate right of A.
6. D neither faces N nor L.



Ultra Practice Bundle PDF for All Bank Prelims Exams

7. K is an immediate neighbour of the one who faces D.

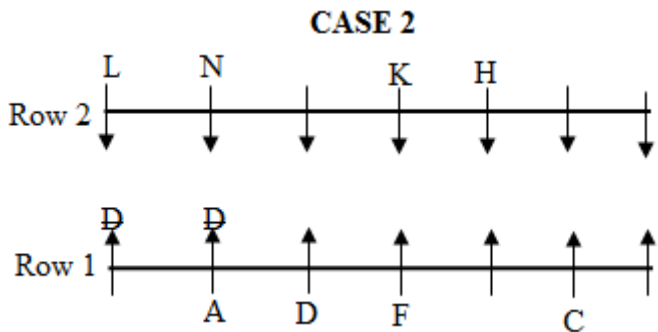
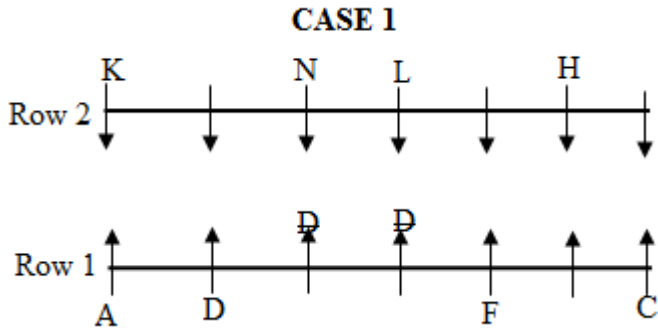

8. The one who faces J sits fifth to the right of G.

9. B sits at one of position to the left of E

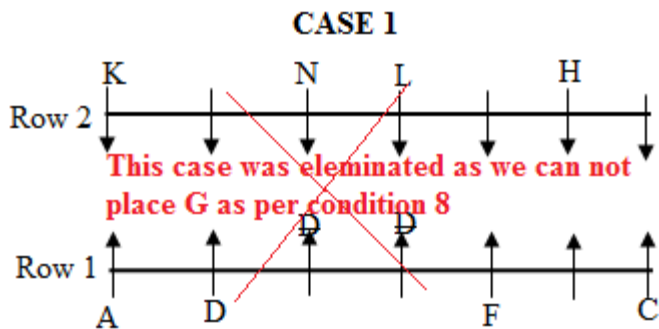

CASE 2

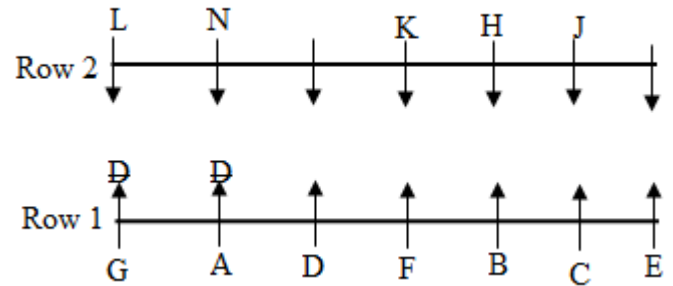

10. I sit fourth to the right of M.

CASE 2

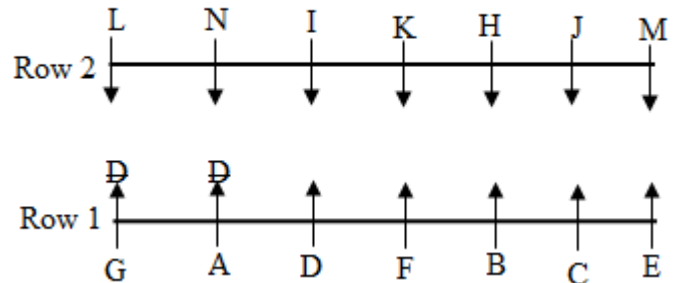

Final Arrangement

CASE 2

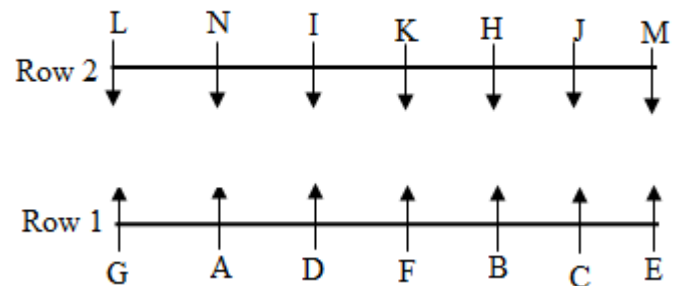

31.c

32.b

33.d

34.e



Ultra Practice Bundle PDF for All Bank Prelims Exams

35.a

SOLUTION (36-40):

- H sits second to the right of C.
- G is ahead H.

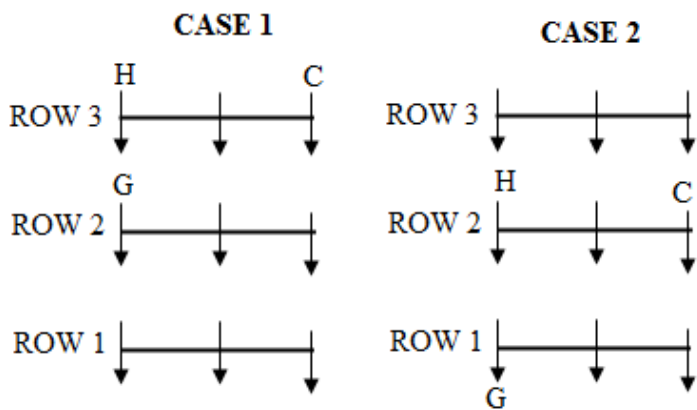

- Only one person's sitting between E and A.
- F sits right of E.
- Both D and B are not the immediate neighbors of E.

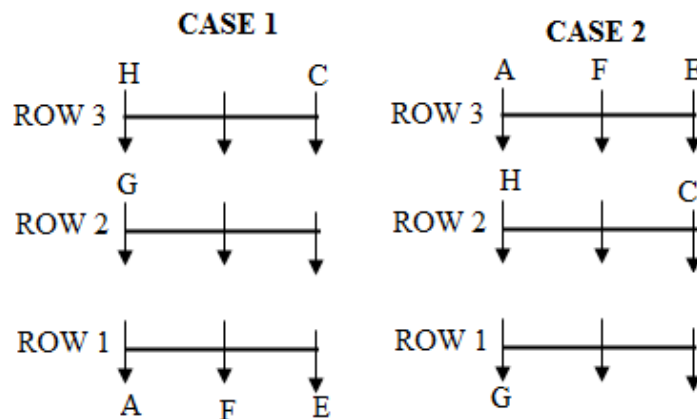

- B sits ahead D.
- F sits ahead of one who immediate right of I.

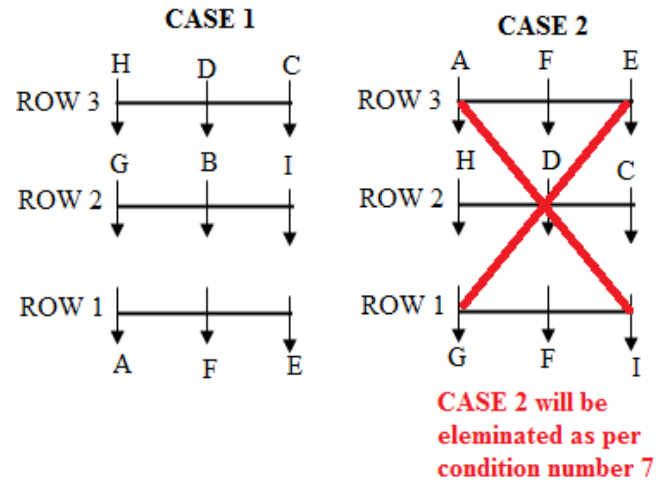

Final Arrangement

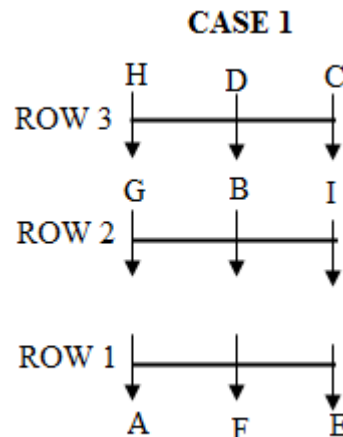

36.d

37.e

38.a

39.d

40.a

SOLUTION (41-45):



Ultra Practice Bundle PDF for All Bank Prelims Exams

1. J sits at one of the extreme ends.
2. Only one person sits between J and the vacant seat.
3. The one who faces vacant seat sit second to the left of D
4. Two persons sit between D and the vacant seat.

CASE 1

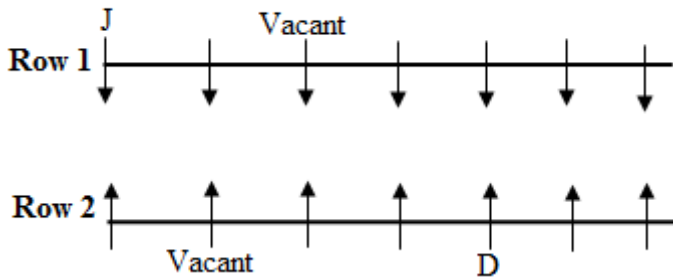

CASE 2

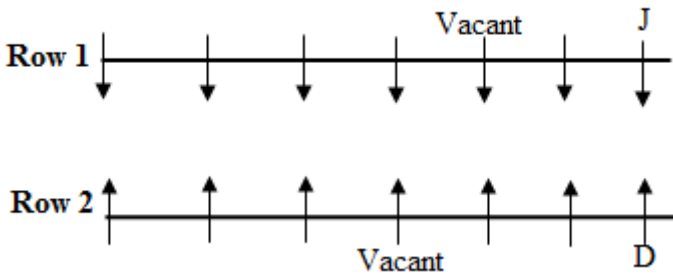

5. The one who faces E sits second to the left of T
6. Three persons sit between E and C.
7. J does not face C

Here we can not count vacant seats as a person

CASE 1

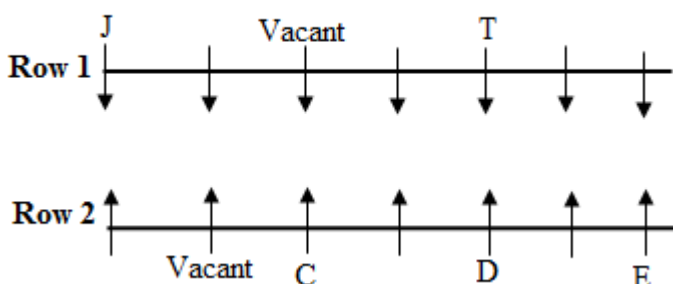

CASE 2

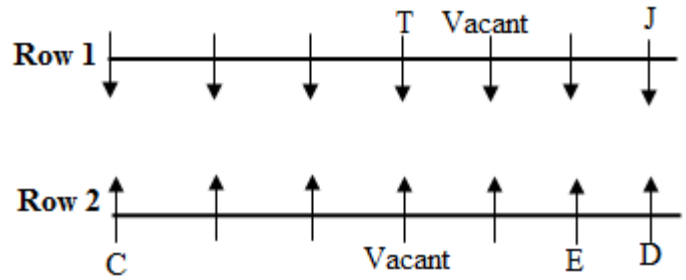

8. The one who faces A sits third to the right of N, who does not sit at any of the extreme end.
9. Only one person sits between O and the one faces B.

CASE 1

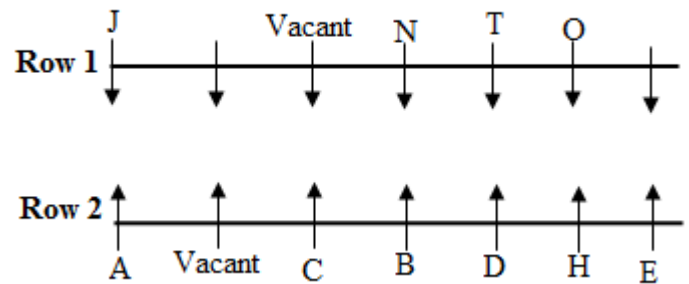

CASE 2

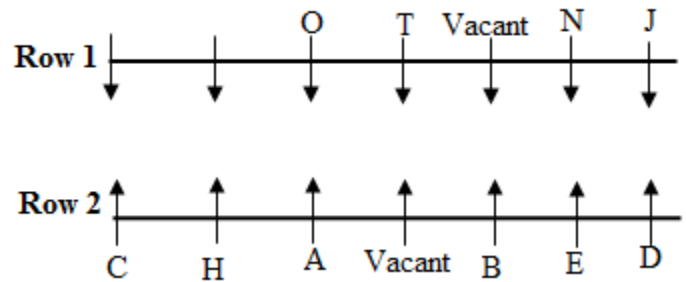

10. As many persons sit to the right of H sit to the right of I.



Ultra Practice Bundle PDF for All Bank Prelims Exams

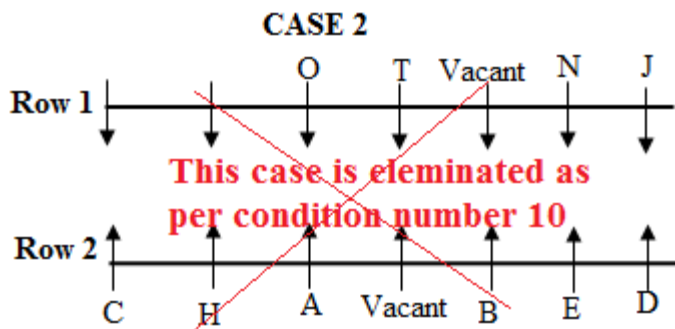
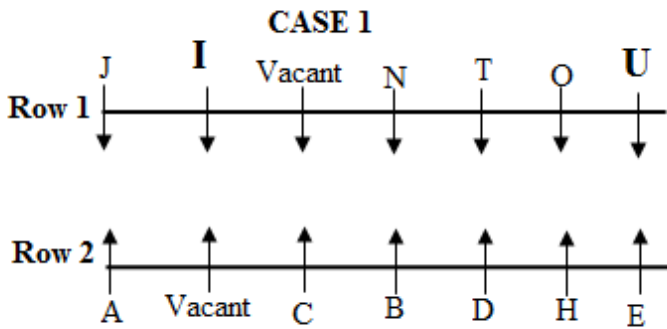

Final Arrangement

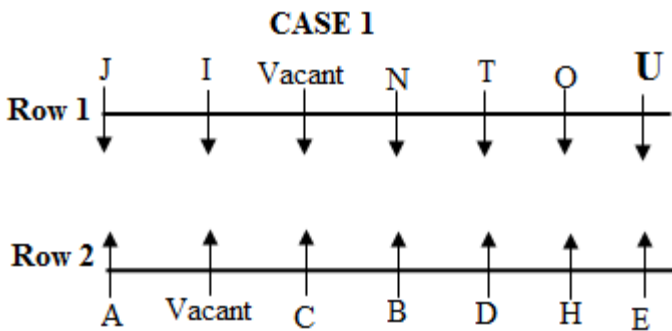

41.a

42.a

43.c

44.d

45.d

SOLUTION (46-50):

1. X sits third to the right of W and sits opposite to J.

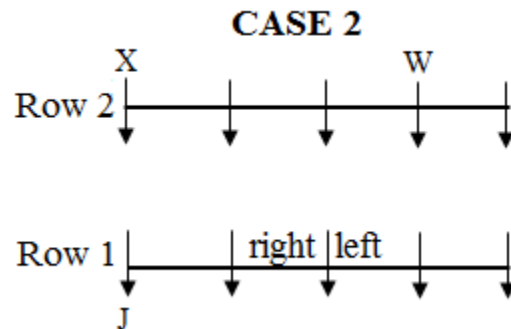
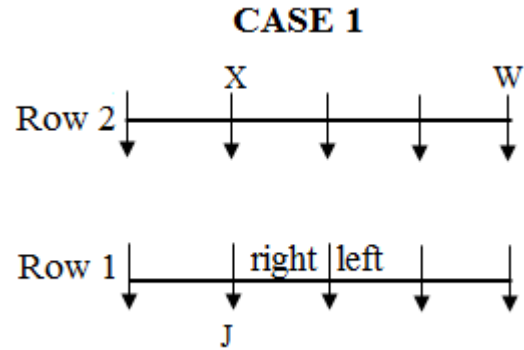

2. U sits to the immediate right of Y.
3. F does not sit opposite to V.
4. F sits second to the right of I.

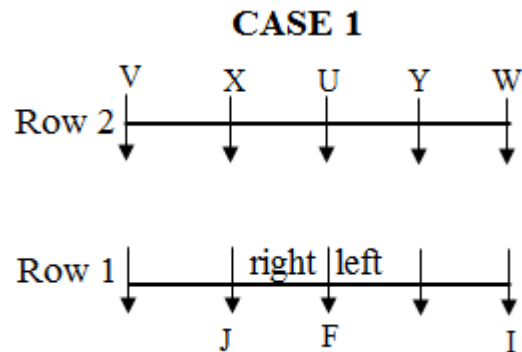



Ultra Practice Bundle PDF for All Bank Prelims Exams

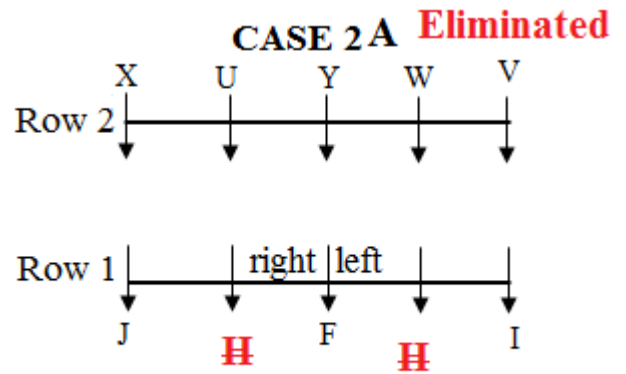
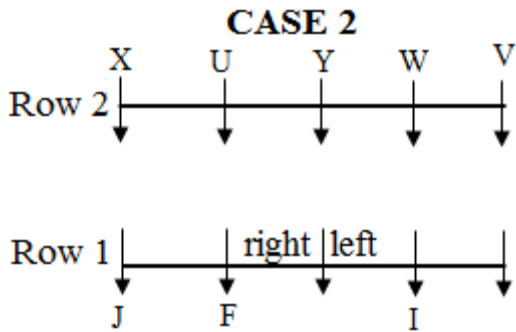

Fails to satisfy the condition 7

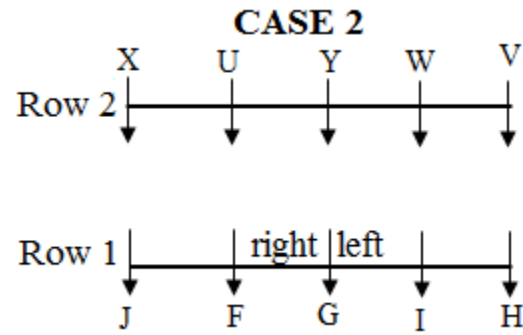
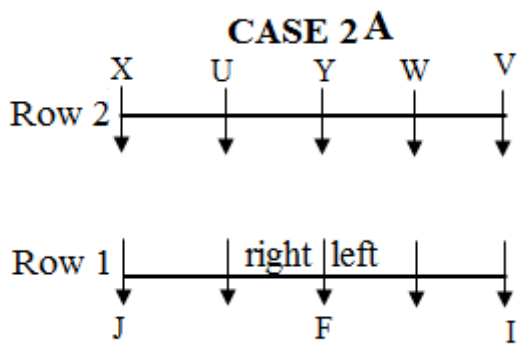

- 5. G sits opposite to neither V nor X.
- 6. There is at most one person between H and G.

Final Arrangement

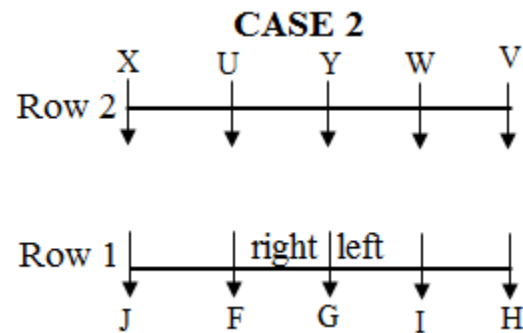
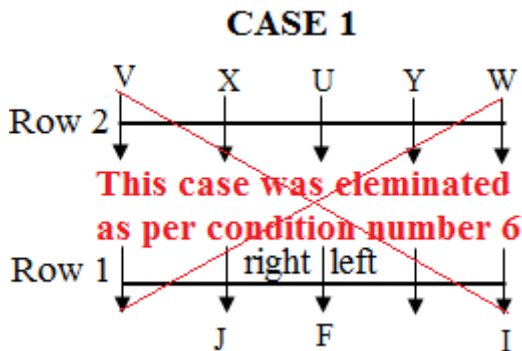

- 7. H and F are not neighbours.

46.c

47.d

48.b

49.a

50.e

2. Circular Seating Arrangement

Directions (1-5): Study the information carefully and answer the questions given below.

There are eleven people B, C, D, E, F, G, H, I, J, K and L sitting in a circle facing outside the centre but not necessarily in the same order. H sits three places away from F. Four persons are sitting between I and K, who is not sitting near to H. D and H are not immediate neighbours. Both G and E sit four places away from J. G sits to the right of J. L sits four places away from G. F sits to the right of G. K sits fourth to the right of C. J sits five places from C. F sits second to the left of J.

- Which of the following combinations represents the first and the second to the left of C respectively?
 - EL
 - EF
 - IG
 - GB
 - KF
- Who is third to the right of L?
 - I
 - J
 - K
 - H
 - D
- Who is to the immediate left of D?
 - H
 - J
 - K
 - F
 - B
- Who is second to the Right of E?
 - L

- K
- F
- H
- D

- In which of the following combinations the third person is second to the left of the second person?
 - GBD
 - DHJ
 - FLK
 - LFE
 - None of these

Directions (6-10): Study the information carefully and answer the questions given below

Nine persons are sitting in a circle only two are facing outside the circle and they both are not sitting together. G is immediate left of L. Only 2 persons sit between H and I who does not sit adjacent to M. L sits 5 places to the left of M and both of them facing opposite direction to each other. N who is not facing centre and not immediate neighbour of I. J sits fourth to the right of S who faces inside. S is not near to G and K. K sits second to G.

- How many person(s) sits between M and G when counted to the left G?
 - 1
 - 2
 - 3
 - 4
 - 5
- Who among the following is third to the right of I?

Ultra Practice Bundle PDF for All Bank Prelims Exams

- (a) H
- (b) M
- (c) L
- (d) G
- (e) J

8. Which of the following combinations correctly show the neighbor(s) of L?

- (a) J, G
- (b) I, N
- (c) G, K
- (d) N, S
- (e) M, K

9. Who among the following sits at immediate left of S?

- (a) G
- (b) L
- (c) I
- (d) N
- (e) H

10. How many person(s) sits between H and L?

- (a) 3
- (b) 4
- (c) 5
- (d) 2
- (e) Either a or b

Directions (11-15): Study the information carefully and answer the questions given below

Ten seats in a circle such that nine persons are sitting around a circular table facing outside the centre. One of the seats is vacant. L sits fourth to the right of H. Only one person sit between L and N. Vacant seat is immediate left to N. O sits third to the left of P. T sits immediate left of O. P and L are not immediate neighbours. O and N are not immediate neighbours. Only one person sits between Q and R. R sits second to the right of S.

11. What is the position of T with respect to S?

- (a) Third to the left

- (b) Immediate left
- (c) Second to the left
- (d) Third to the right
- (e) None of these

12. Which of the following statement is correct?

- (a) H sits immediate right of S.
- (b) Only three persons sit between N and L.
- (c) Q sits second to the left of N.
- (d) L sits to the immediate left of R.
- (e) None of these

13. How many seats between the one who sits to the immediate left of H and the one who sits to the immediate right of R?

- (a) One
- (b) Two
- (c) Four
- (d) No one
- (e) None of these

14. Which of the following person are immediate neighbor of vacant seats?

- (a) R-P
- (b) N-Q
- (c) P-S
- (d) H-O
- (e) T-L

15. What is the position of P with respect to the one who sits to the immediate right of T?

- (a) Second to the right
- (b) Second to the left
- (c) Third to the right
- (d) Third to the left
- (e) None of these

Directions (16-20): Study the information carefully and answer the questions given below

Ten persons are sitting in a circle facing outside the centre. D sit third to the right of L. B is an immediate neighbor of D. Three persons sits between B and G. Less than three persons sit between L and G when counted to the left of L. F sits immediate left of G. Three persons sit between M and P. M is immediate right of V. R sits fifth to the right of H who is not immediate neighbor of L.

Ultra Practice Bundle PDF for All Bank Prelims Exams

16. What is the position of F with respect to L?

- (a) Second to the left
- (b) Immediate left
- (c) Third to the right
- (d) Third to the left
- (e) None of these

17. Which of the following pairs sits opposite to each other?

- (a) R, F
- (b) P, V
- (c) D, P
- (d) L, V
- (e) V, G

18. Which of the following statement is true?

- (a) R sits opposite to F
- (b) D sits at immediate right of V
- (c) Only one person sits between P and B
- (d) P sits second to the left of F
- (e) All the above statements are false

19. What is the position of the one who sits the immediate right of L with respect to the one who sits second to the left of M?

- (a) Second to the left
- (b) Second to the right
- (c) Third to the left
- (d) Third to the right
- (e) None of these

20. If we change the direction of H then which of the following person sit third to the right of H?

- (a) P
- (b) G
- (c) D
- (d) V
- (e) B

Directions (21-25): Study the information carefully and answer the questions given below

Eight persons i.e. P, Q, R, S, T, U, V and W are sitting around a circle at an equal distance. Three persons on the circle are facing opposite side and other five are sitting facing to the center of the circle. Q is sitting third to the left of U. Two are sitting between U and T. S is not near to W. Two persons are sitting between W and T. R is sitting third to the right of S. S sits second to the right of P. Among P, R and S one is facing inside the center of the circle. R is sitting second to the left of V, who is facing the inside of the circle. T is not opposite to U and R. Q faces to the outside of the centre.

21. Which of the following person sits to the immediate left of S?

- (a) W
- (b) V
- (c) Q
- (d) T
- (e) None of these

22. How many persons sit between R and P?

- (a) One
- (b) Two
- (c) Three
- (d) Four
- (e) None of these

23. If V is related to P, U is related to Q, in the same way S is related to which of the following?

- (a) Q
- (b) T
- (c) V or R
- (d) W
- (e) None of these

24. Which of the following statement is true?

- (a) U sits second to the left of V
- (b) Three persons sit between Q and R
- (c) More than two persons sit between V and S when counted to the right of V
- (d) P sits third to the right of W
- (e) Immediate neighbours of T facing same direction to each other.

Ultra Practice Bundle PDF for All Bank Prelims Exams

25. Which of the following sits third to the right of V?

- (a) S
- (b) T
- (c) P
- (d) R
- (e) None of these

Directions (26-30): Study the information carefully and answer the questions given below

Eight persons are sitting around a circular table. Some of them are facing inside the center while some are facing outside the center. S sits second to the right of P. T sits third to the left of S. U sits opposite to Q and Q is not an immediate neighbor of S. S is facing same direction of P. V sits Immediate to the right of W who is not immediate neighbor of Q. R neither sits opposite to T nor P. Both V and W are facing opposite direction. W is facing outside the center of the circle. Both T and Q are facing opposite direction as V. While both R and U are facing same direction to each other but opposite to S.

26. How many persons faces outside the centre?

- (a) 1
- (b) 2
- (c) 3
- (d) 4
- (e) 5

27. What is the position of Q with respect to P?

- (a) Fourth to the left
- (b) Third to the left
- (c) Second to the left
- (d) Fifth to the right
- (e) None of these

28. How many persons sit between W and T, when counted from the left of former?

- (a) 1
- (b) 2
- (c) 3
- (d) 4
- (e) 5

29. Who sits third to the left of the one who is immediate right of V?

- (a) R
- (b) U
- (c) S
- (d) P
- (e) Q

30. How many persons sit between U and R?

- (a) 2
- (b) 3
- (c) 4
- (d) 5
- (e) Either a or c

Directions (31-35): Study the information carefully and answer the questions given below

Twelve people N, O, X, V, Z, W, H, I, J, K, L and M are sitting in the circle. All of them facing inside the centre. N sits third to the left of Z. Three persons sit between Z and H. Three people sit between M and I. M is not immediate neighbour of Z. H sits second to the right of L. I faces N. Only one Person sits between W and O. Neither W nor O faces H and Z. X does not face H. J sits third to the left of X who does not faces W. K is not an immediate neighbour of X. Neither W nor O is opposite to J

31. Who among the following sits 4th to the right of J?

- (a) I
- (b) V
- (c) X
- (d) L
- (e) M

32. Who among the following is immediate neighbour of O?

- (a) Z, W
- (b) K, Z
- (c) N, H
- (d) M, L
- (e) W, J

Ultra Practice Bundle PDF for All Bank Prelims Exams

33. In which of the following pairs second person sits second to the right of the first person?

- (a) M, O
- (b) K, H
- (c) Z, J
- (d) N, M
- (e) None of these

34. How many persons are there exactly between J and H?

- (a) One
- (b) Two
- (c) Three
- (d) None
- (e) None of these

35. Who among the following is third to the right of X?

- (a) H
- (b) L
- (c) M
- (d) O
- (e) N

Directions (36-40): Study the information carefully and answer the questions given below

Seven people C, D, E, F, G, H and I sitting in a Circle with equal distance between them, but not necessarily in the same order. Some of them are facing centre and some are facing outside the centre. Only two people sit between I and D. C sits second to the right of D. The immediate neighbours of C face opposite directions. Only one person sits between C and E. H sits third to the right of E. Both the immediate neighbours of E face the same direction as C. C faces the same direction as that of E. G faces inside. D sits to the immediate left of G.

36. Who amongst the following sits on the immediate right of H?

- (a) C
- (b) I
- (c) D

- (d) G
- (e) None of these

37. Who amongst the following sits third to the right of G?

- (a) D
- (b) E
- (c) F
- (d) I
- (e) None of these

38. How many persons faces outside the centre?

- (a) 1
- (b) 2
- (c) 3
- (d) 4
- (e) 5

39. If all the people are made to sit in an alphabetical order, in clockwise direction, starting from C, the position of whom amongst the following remains the same (excluding C)?

- (a) 1
- (b) 2
- (c) 3
- (d) 4
- (e) None of these

40. How many people are seated between G and C (counting clockwise from G)?

- (a) Two
- (b) Four
- (c) None
- (d) One
- (e) Three

Directions (41-45): Study the information carefully and answer the questions given below

Eight Persons G, H, I, J, T, B, E and X are sitting in a circular table. Two persons are facing outside the center

Ultra Practice Bundle PDF for All Bank Prelims Exams

and others are facing inside the center. G sits 2nd to the left of B who sits immediate right of T. There are three persons sit between X and E who is not an immediate neighbor of G. H sits 3rd to the left of the person who sits immediate right of B. E and J are immediate neighbors of I. G and X are facing opposite direction as T are facing.

41. What is position of E with respect to G?

- (a) Third to the right
- (b) E and G are opposite to each other
- (c) Second to the right
- (d) Third to the left
- (e) Fifth to the right

42. Who sits adjacent to both B and G?

- (a) T
- (b) X
- (c) H
- (d) J
- (e) I

43. Which of the following pairs of the person sits between H and E when counted to the left of E?

- (a) X, G
- (b) I, J
- (c) T, G
- (d) B, T
- (e) T, X

44. Who among the following sit between X and J when counted in anti-clockwise direction from X?

- (a) No one sits between X and J as X and J are immediate neighbours of each other
- (b) G
- (c) T
- (d) H
- (e) E

45. If I is made to face the opposite direction, who would sit to his immediate right?

- (a) H
- (b) J
- (c) E
- (d) B
- (e) T

Directions (46-50): Study the information carefully and answer the questions given below

Ten seats in a circle such that nine J, K, L, M, N, P, Q and S persons are sitting around a circular table facing centre. One of the seats is vacant. M is fourth to the right of K. There are two people between vacant seat and M. L sits immediate right of vacant seats. R seats immediate right of M. There are two persons between N and J. P sits immediate left of Q. There are two people between P and N when counted to the left of N.

46. Who sits second to the left of Vacant Seat?

- (a) J
- (b) N
- (c) S
- (d) Q
- (e) None of these

47. Who sits adjacent to both K and L?

- (a) N
- (b) L
- (c) S
- (d) No one
- (e) None of these

48. How many persons sits between N and J when counted to the left of J?

- (a) None
- (b) One
- (c) Two



Ultra Practice Bundle PDF for All Bank Prelims Exams

- (d) Three
- (e) Four

49. Which of the following pairs are immediate neighbor of each other?

- (a) S, K
- (b) Q, R
- (c) R, J
- (d) P, R

- (e) None of these

50. Who sits fourth to the right of Q?

- (a) P
- (b) R
- (c) M
- (d) J
- (e) Vacant

Solution and Detailed Explanation

SOLUTION (1-5):

- 11. Both G and E sit four places away from J.
- 12. G sits to the right of J.
- 13. J sits five places from C.

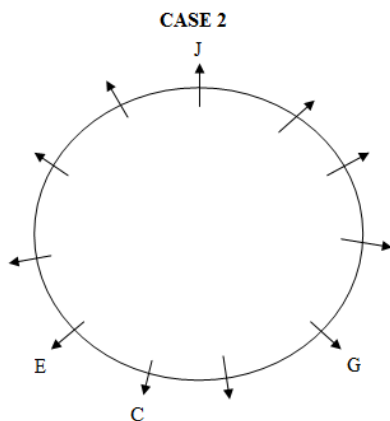
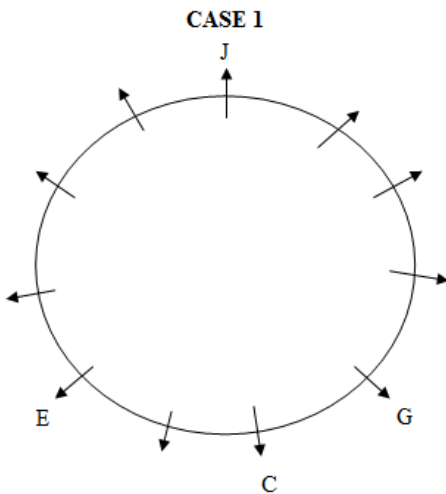

14. K sits fourth to the right of C

15. Four persons are sitting between I and K.

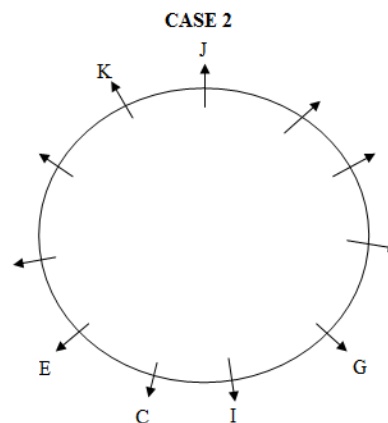
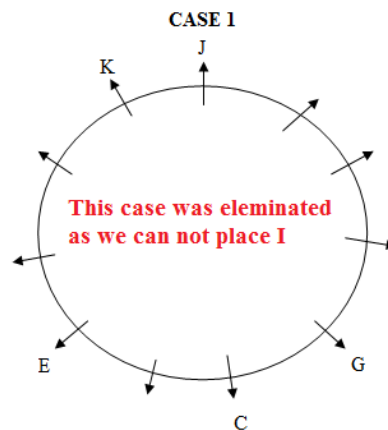

- 16. H sits three places away from F.
- 17. K is not sitting near to H.
- 18. L sits four places away from G
- 19. D and H are not immediate



Ultra Practice Bundle PDF for All Bank Prelims Exams

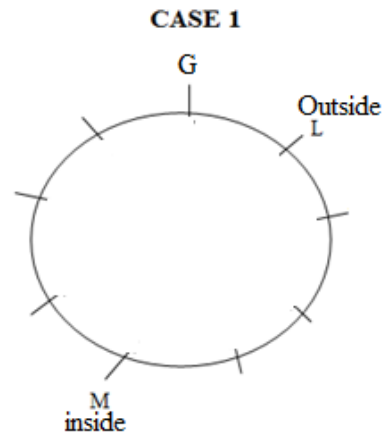
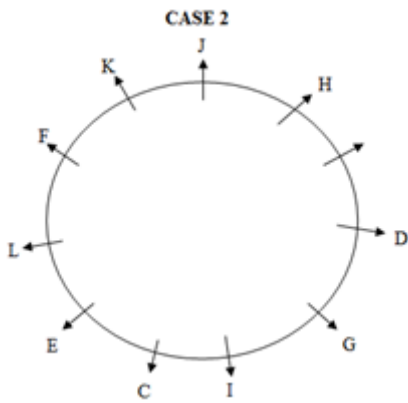

Final Arrangement

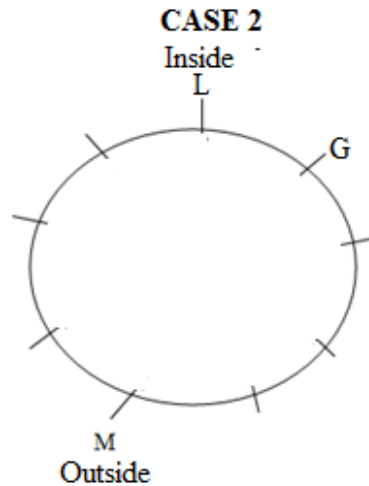
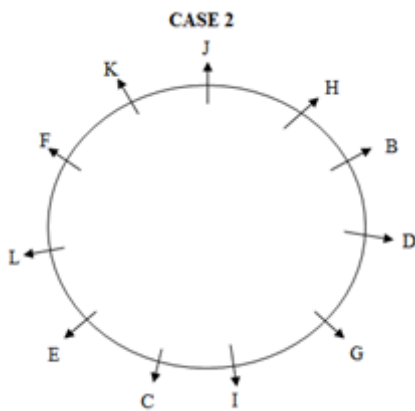

- 1.c
- 2.b
- 3.e
- 4.c
- 5.d

SOLUTION (6-10):

1. L sits 5 places to the left of M and both of them facing opposite direction to each other.
2. G is immediate left of L

3. K sits second to G.
4. J sits fourth to the right of S who faces inside.
5. S is not near to G and K

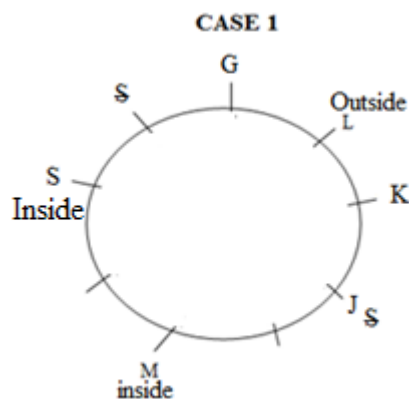



Ultra Practice Bundle PDF for All Bank Prelims Exams

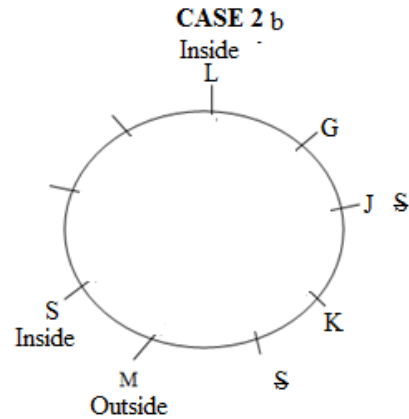
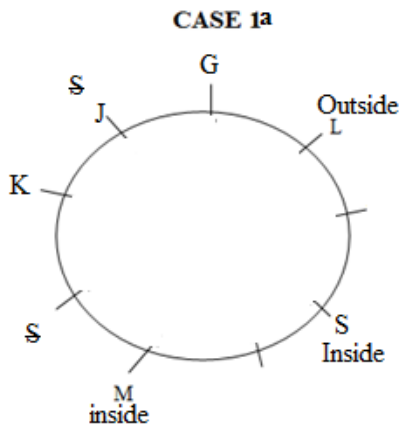

6. Only 2 persons sit between H and I who does not sit adjacent to M.

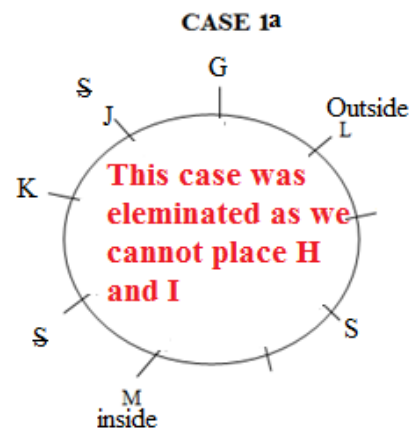
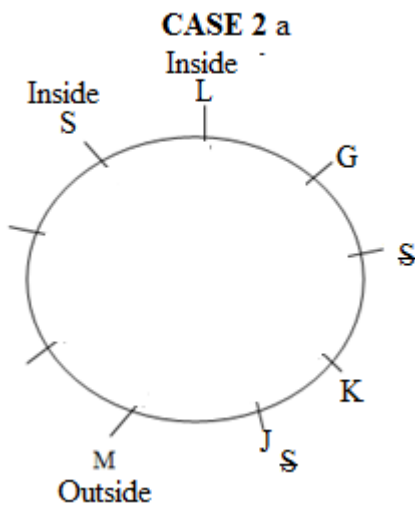
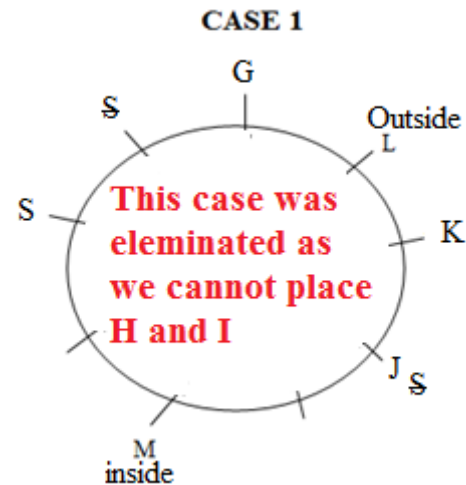
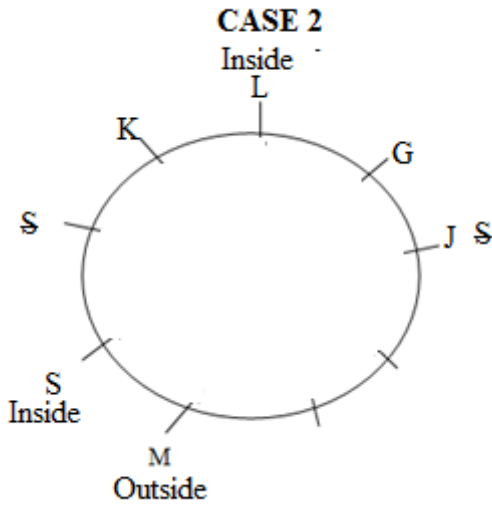



Ultra Practice Bundle PDF for All Bank Prelims Exams

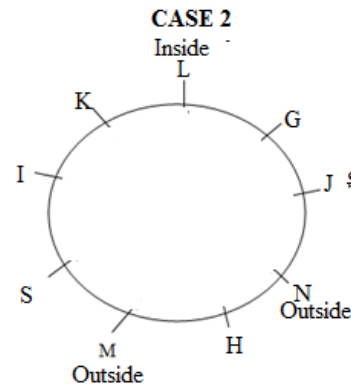
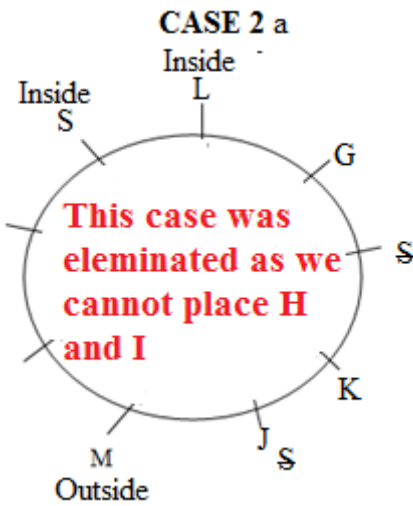
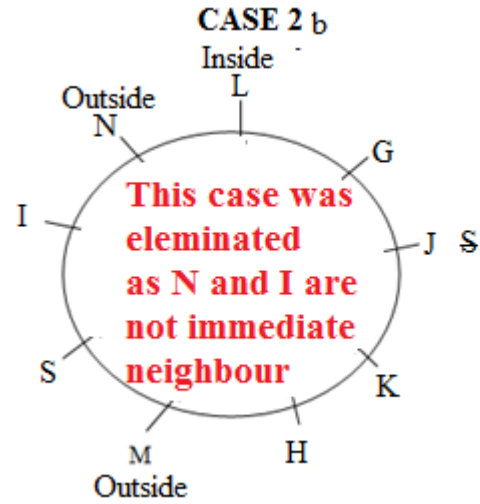
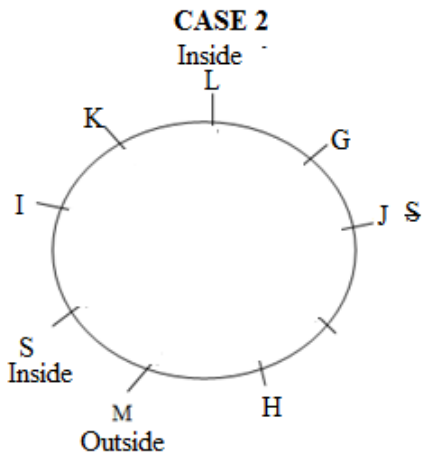

Final Arrangement

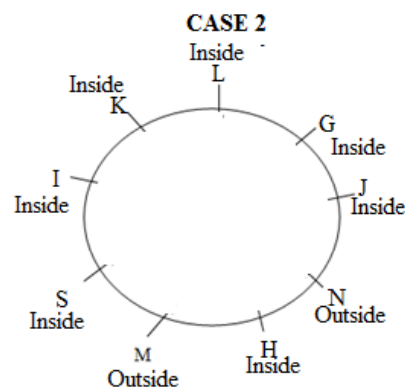
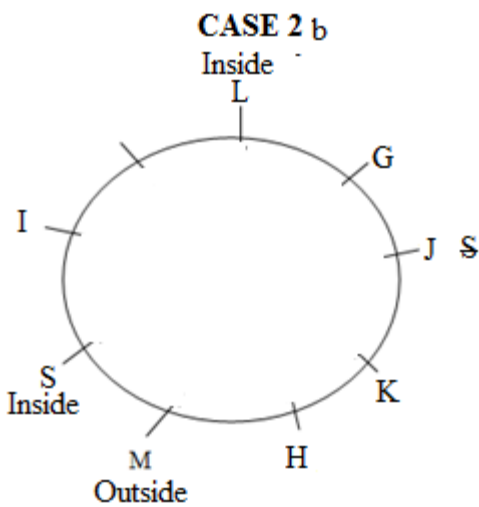

6.c

7.a

8.c

9.c

7. N who is not facing centre and not immediate neighbour of I.



Ultra Practice Bundle PDF for All Bank Prelims Exams

10.e

SOLUTION (11-15):

1. Only one person sit between L and N.
2. Vacant seat is left to N.
3. L sits fourth to the right of H.

CASE 1

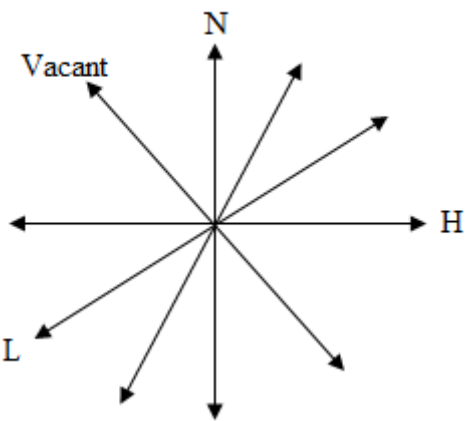

CASE 2

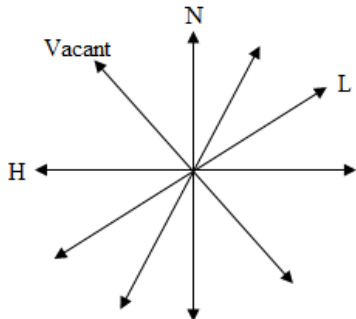

4. O sits third to the left of P.
5. T sits immediate left of O.
6. P and L are not immediate neighbours.
7. O and N are not immediate neighbours.

Here we can place P at only one place other wise 5th condition was wrong

CASE 1

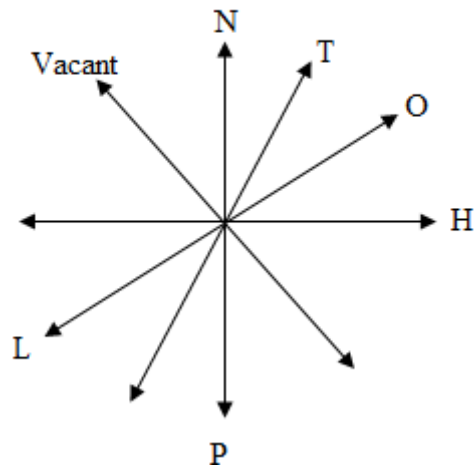

CASE 2

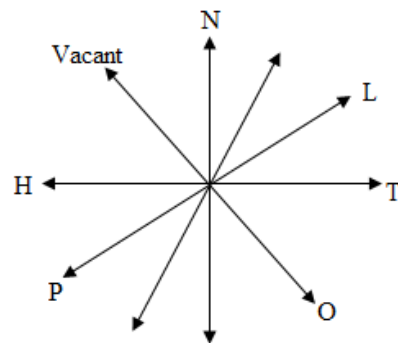

8. Only one person sits between Q and R.
9. R sits second to the right of S.

CASE 1

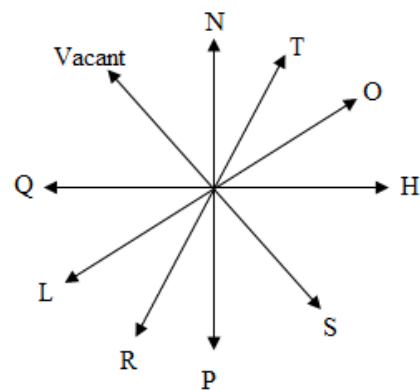



Ultra Practice Bundle PDF for All Bank Prelims Exams

CASE 2

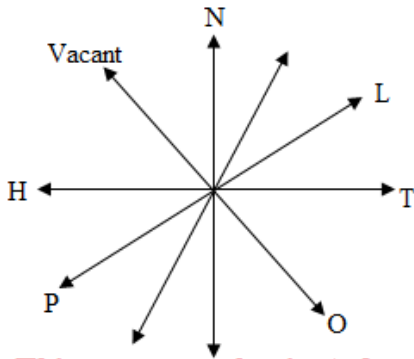

This case was eliminated as we cannot place Q, R and S

CASE 1

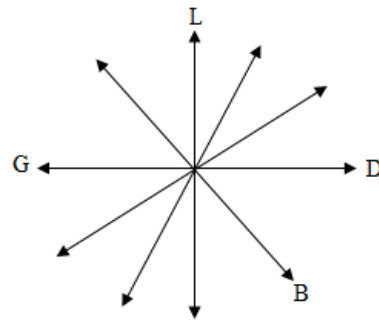

CASE 2

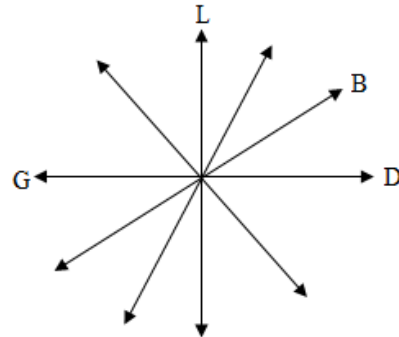

Final Arrangement

CASE 1

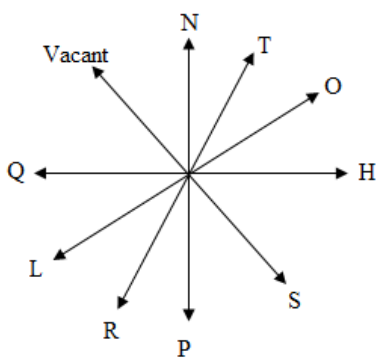

- 5. F sits immediate left of G.
- 6. R sits fifth to the right of H who is not immediate neighbor of L.

CASE 1

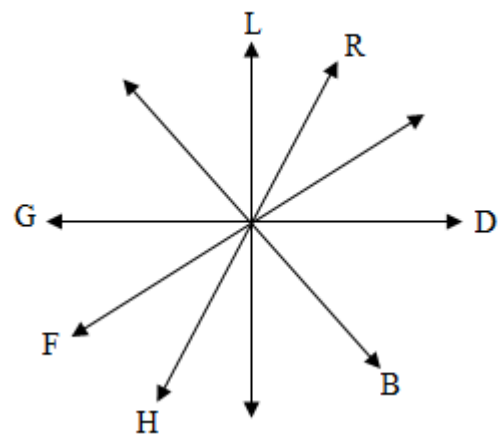

11.a

12.c

13.c

14.b

15.c

SOLUTION (16-20):

- 1. D sits third to the right of L.
- 2. B is an immediate neighbor of D.
- 3. Three persons sit between B and G.
- 4. Less than three persons sit between L and G when counted to the left of L.



Ultra Practice Bundle PDF for All Bank Prelims Exams

CASE 2 a

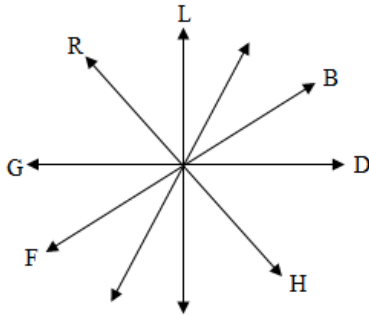

CASE 2 b

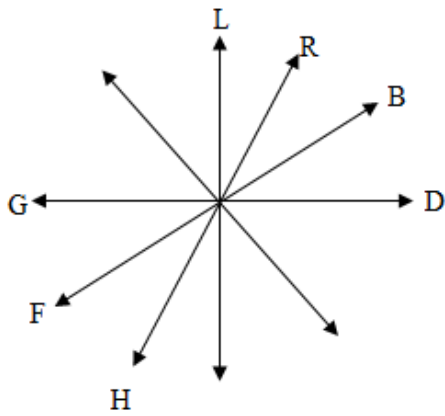

- 7. Three persons sit between M and P.
- 8. M is immediate right of V.

CASE 1

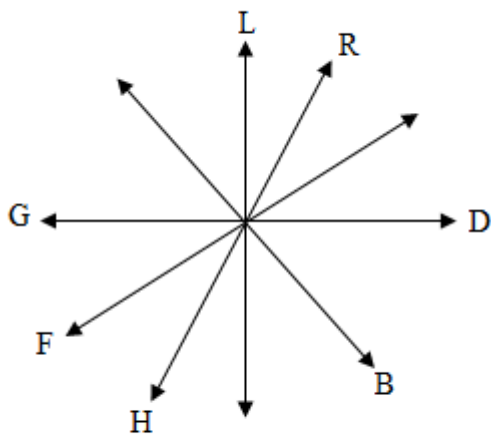

This case was eliminated as we can not place M and

CASE 2 a

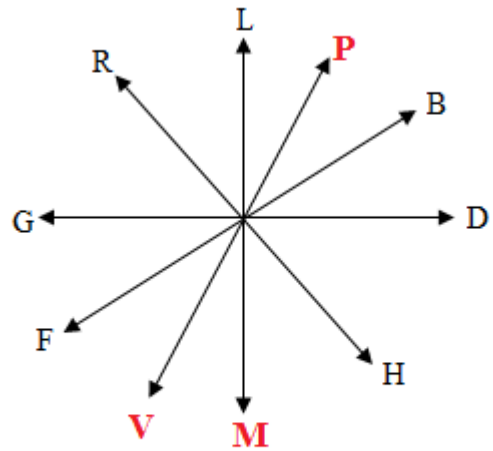

This case was eliminated as we can not place M immediate right of V

CASE 2 b

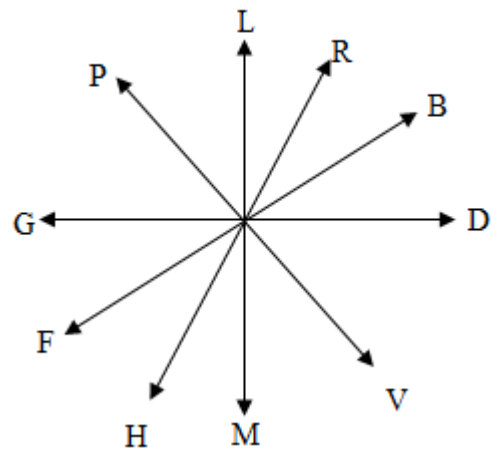

Final arrangement

CASE 2 b

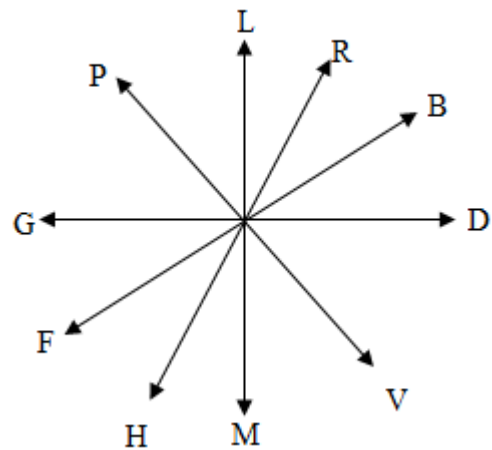



Ultra Practice Bundle PDF for All Bank Prelims Exams

16.d

17.b

18.e

19.a

20.c

SOLUTION (21-25):

1. Q is sitting third to the left of U.
2. Two are sitting between U and T.
3. S is not near to W.
4. Two persons are sitting between W and T
5. Q faces to the outside of the centre.

CASE 1

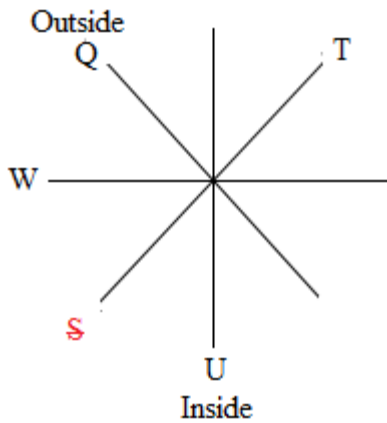

CASE 2

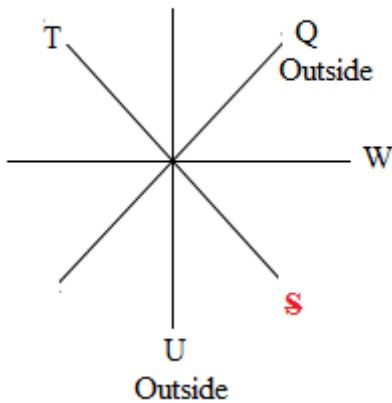

6. R is sitting third to the right of S.
7. S sits second to the right of P.
8. Among P, R and S one is facing inside the center of the circle.
9. R is sitting second to the left of V, who is facing the inside of the circle.
10. T is not opposite to U and R.

CASE 1

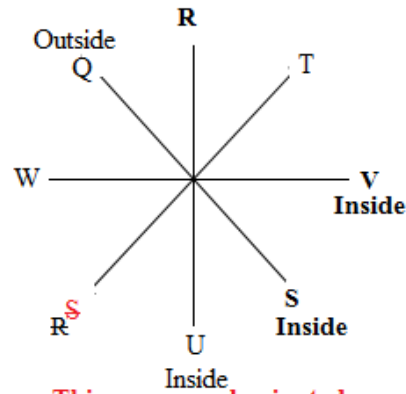

This case was eliminated because R is not 2nd to the left of V

CASE 1a

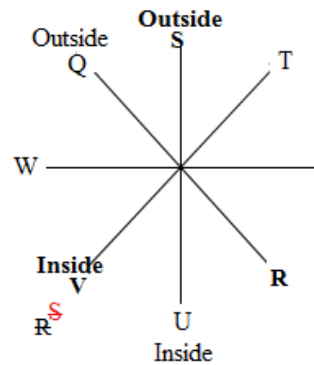

This case was eliminated because R is not 2nd to the left of V



Ultra Practice Bundle PDF for All Bank Prelims Exams

CASE 2

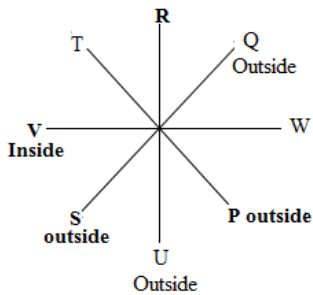

This case was eliminated as more than 3 person faces outside the centre

CASE 2a

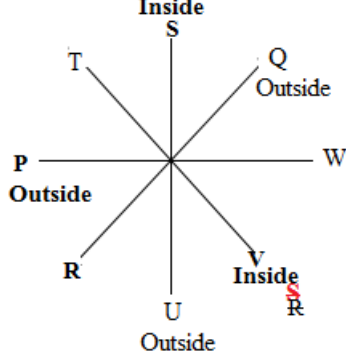

From here we can find the direction of T, R and W as P, Q, and U faces outside so T, R and W faces inside the circle

Final Arrangement

CASE 2a

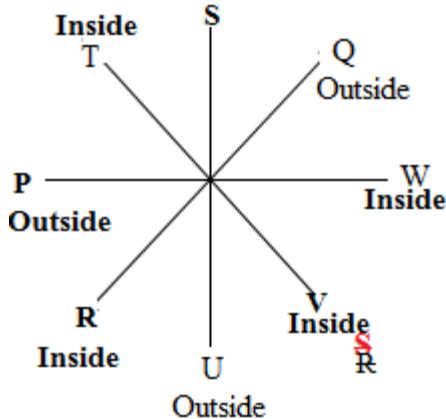

21.c

22.e (R and P are immediate neighbour)

23.c (Two person sits to the left S and V or R)

24.b

25.a

SOLUTION (26-30):

1. S sits second to the right of P.
2. T sits third to the left of S.
3. U sits opposite to Q and Q is not an immediate neighbor of S.
4. S is facing same direction of P.

CASE 1

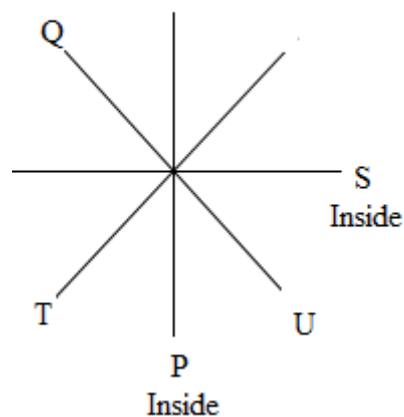

CASE 2

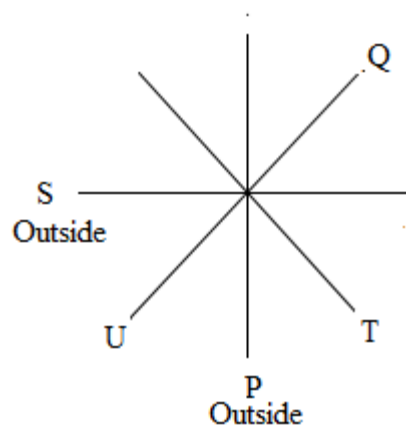

5. R neither sits opposite to T nor P.
6. Both R and U are facing same direction to each other but opposite to S.



Ultra Practice Bundle PDF for All Bank Prelims Exams

- 7. V sits Immediate to the right of W who is not immediate neighbor of Q.
- 8. Both V and W are facing opposite direction.
- 9. W is facing outside the centre of the circle

Given that W and V faces opposite direction and it is also given W faces out side hence V faces inside the centre

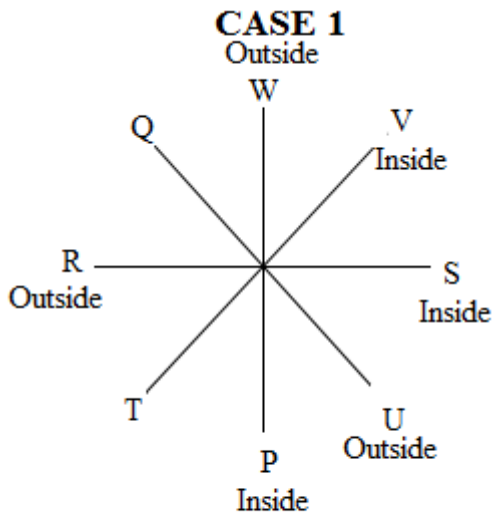

This case was eliminated as W and Q are immediate neighbour

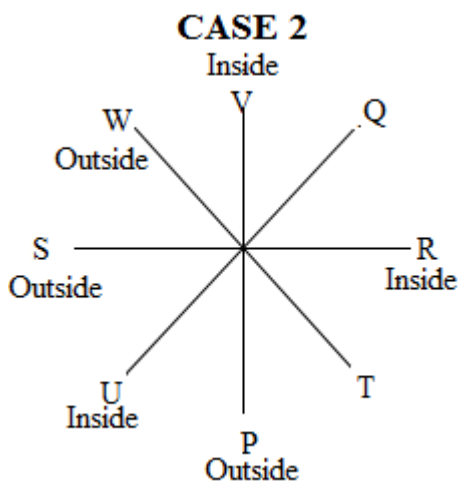

- 10. Both T and Q are facing opposite direction as V.

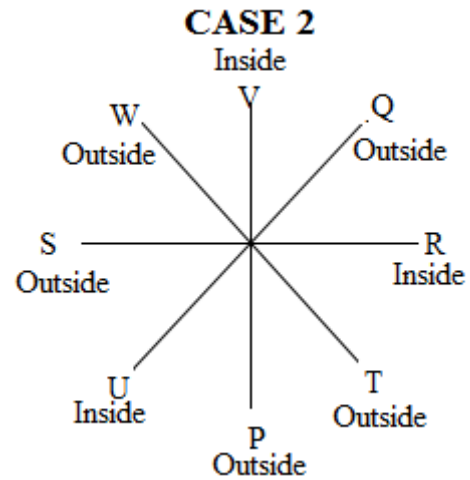

Final Arrangement

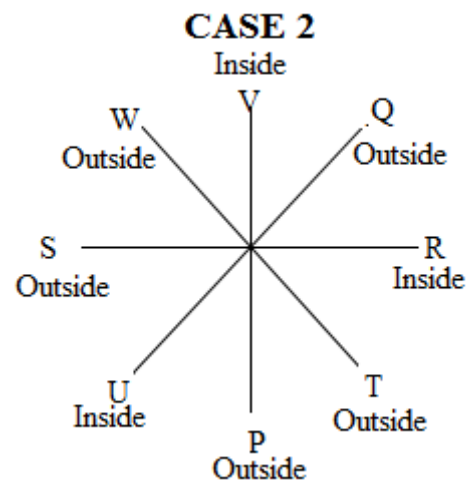

26.e

27.b

28.c

29.d

30.e

SOLUTION (31-35):

ALL PERSON FACING INSIDE

- 1. N sit third to the left of Z.
- 2. Three persons sit between Z and H



Ultra Practice Bundle PDF for All Bank Prelims Exams

CASE 1

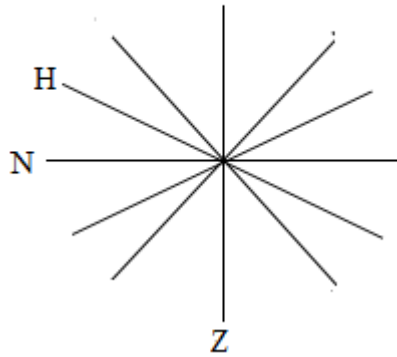

CASE 2

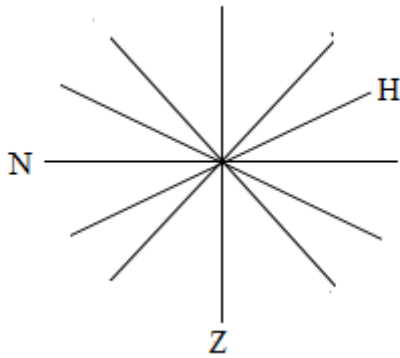

- 3. Three people sit between M and I
- 4. M is not immediate neighbour of Z
- 5. I face N
- 6. H sits second to the right of L

CASE 1

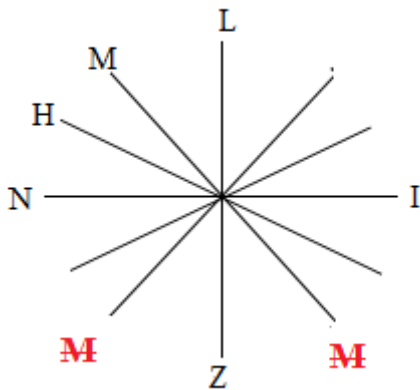

CASE 2

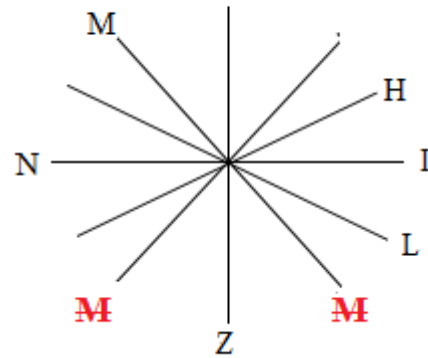

- 7. Only one Person sits between W and O.
- 8. Neither W nor O faces H and Z

CASE 1

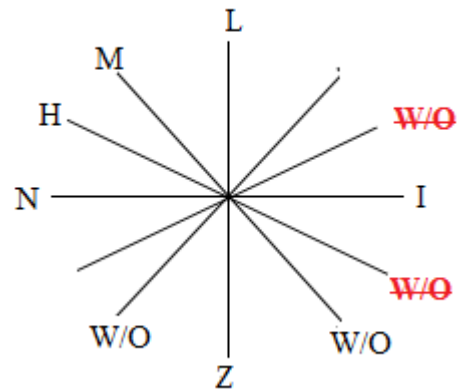

CASE 2

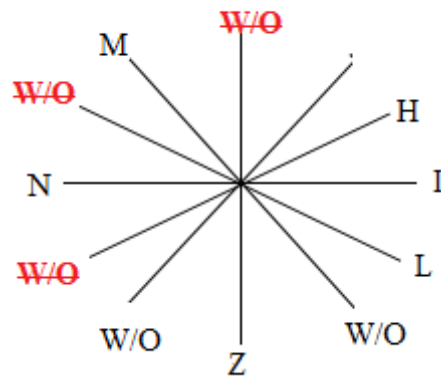

- 9. X does not face H.
- 10. J sits third to the left of X who does not face W.
- 11. Neither W nor O is opposite to J



Ultra Practice Bundle PDF for All Bank Prelims Exams

CASE 1

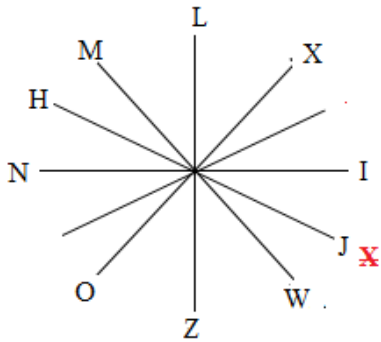

CASE 2

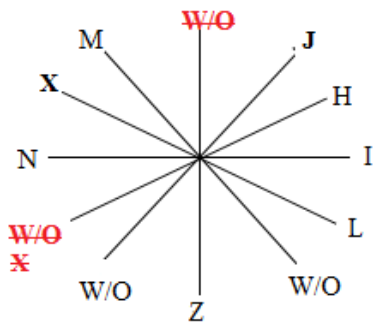

This case was eliminated as J is not opposite to W and O

12. K is not an immediate neighbour of X.

CASE 1

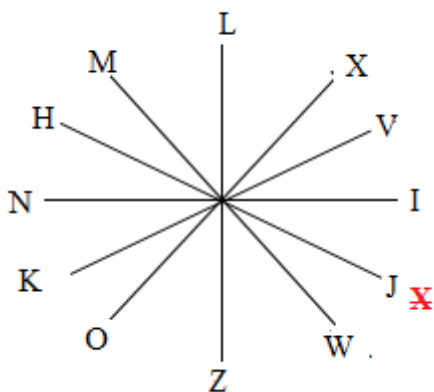

Final Arrangement

CASE 1

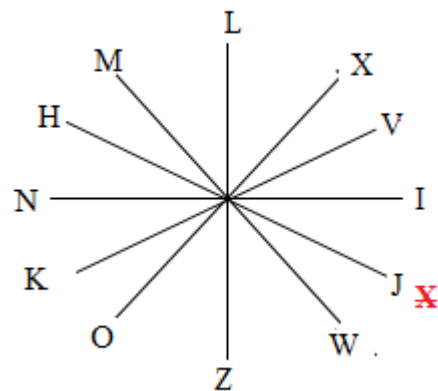

31.d

32.b

33.c

34.e (five)

35.a

SOLUTION (36-40):

1. G faces inside.
2. D sits to the immediate left of G.
3. C sits second to the right of D.
4. Only one person sits between C and E

CASE 1

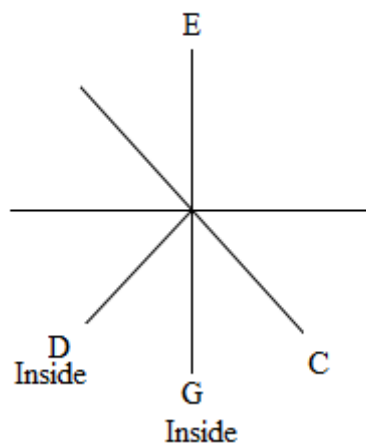



Ultra Practice Bundle PDF for All Bank Prelims Exams

CASE 2

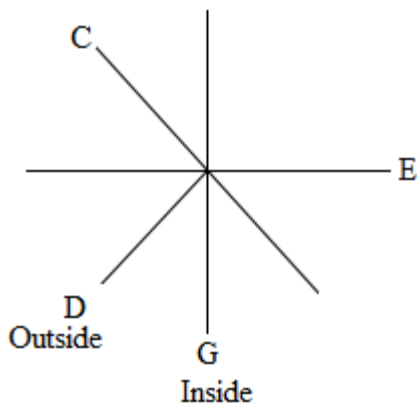

- 5. Only two people sit between I and D.
- 6. H sits third to the right of E

CASE 1

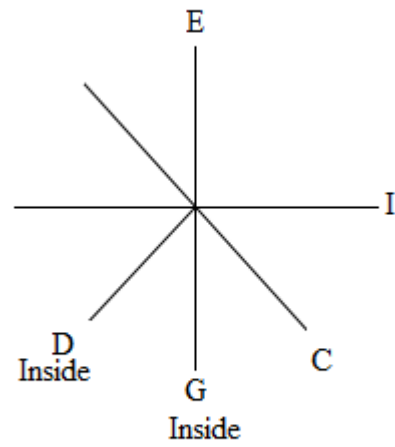

This case was eliminatd as we cannot place H

CASE 2

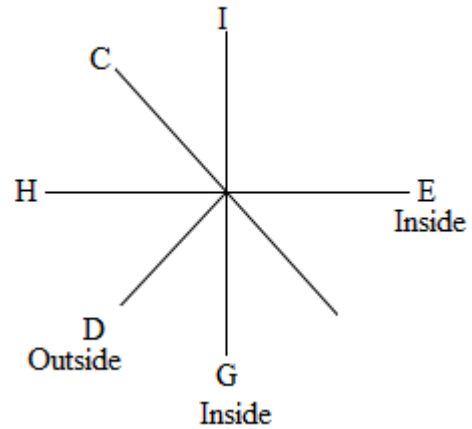

CASE 1

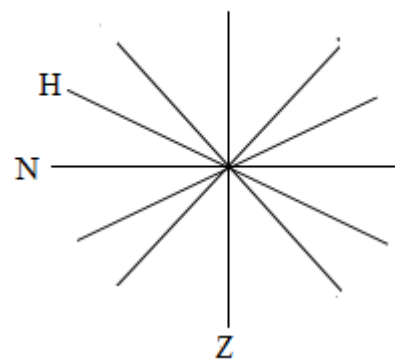



Ultra Practice Bundle PDF for All Bank Prelims Exams

CASE 2

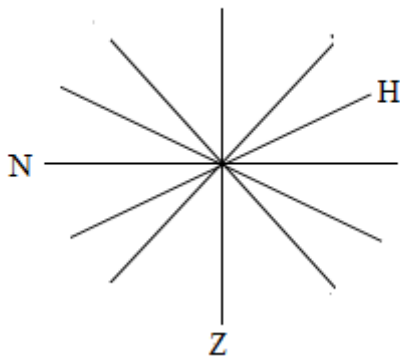

- 7. C faces the same direction as that of E.
- 8. The immediate neighbours of C face opposite directions.
- 9. Both the immediate neighbours of E face the same direction as C

CASE 2

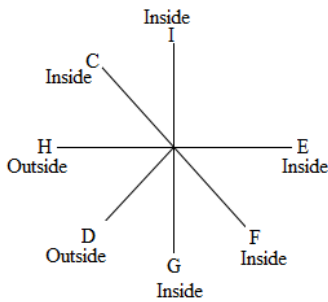

Final Arrangement

CASE 2

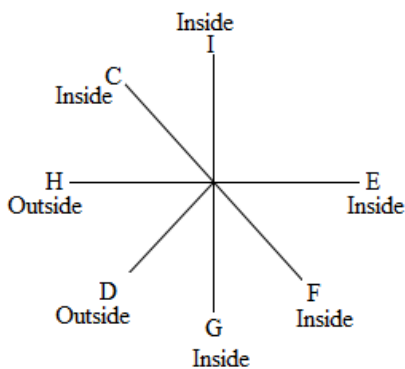

36.a

37.d

38.b

39.c

40.a

SOLUTION (41-45):

- 1. G sits 2nd to the left of B
- 2. H sits 3rd to the left of the person who sits immediate right of B

CASE 1

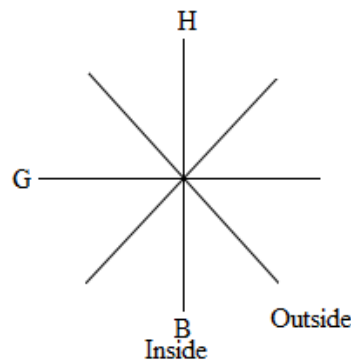

CASE 2

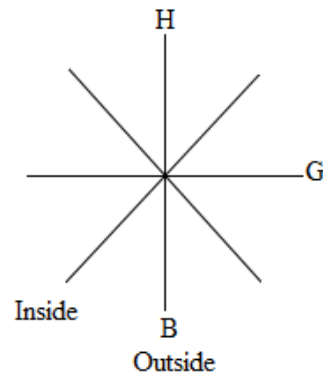

- 3. E and J are immediate neighbors of I.
- 4. B sits immediate right of T



Ultra Practice Bundle PDF for All Bank Prelims Exams

CASE 1

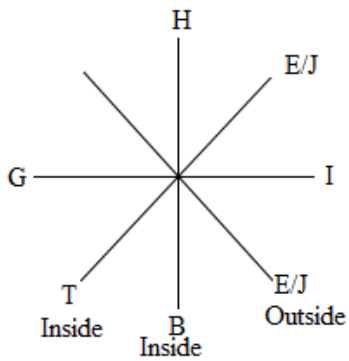

CASE 2

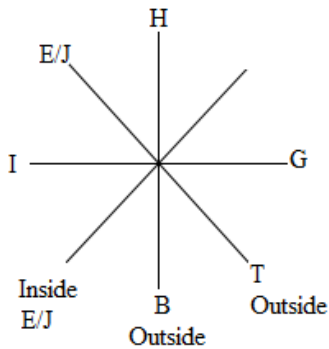

5. There are three persons sit between X and E who is not an immediate neighbor of G
6. G and X are facing opposite direction as T are facing.

CASE 1

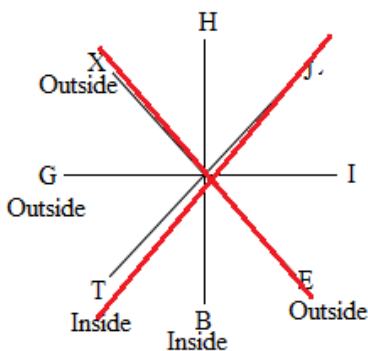

This case was eliminated as given in the instruction part only two person faces outside

CASE 2

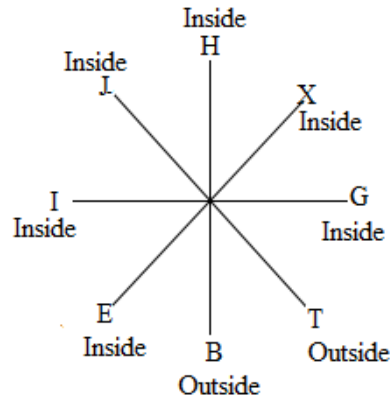

Final Arrangement

CASE 2

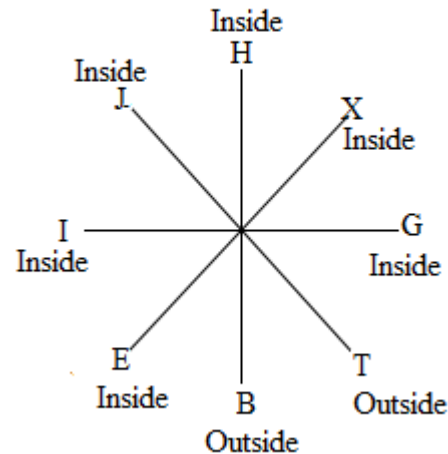

41.d

42.a

43.b

44.d

45.b

SOLUTION (46-50):

All the person facing Inside

1. M is fourth to the right of K.
2. R seats immediate right of M.



Ultra Practice Bundle PDF for All Bank Prelims Exams

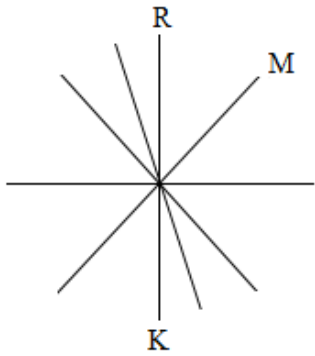

3. There are two people between vacant seat and M.
4. L sits immediate right of vacant seats.

CASE 1

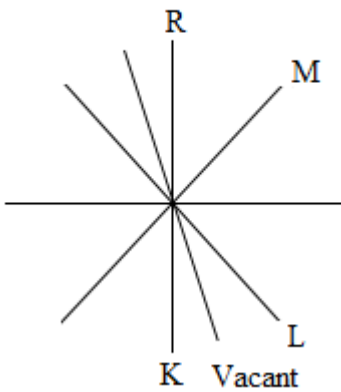

CASE 2

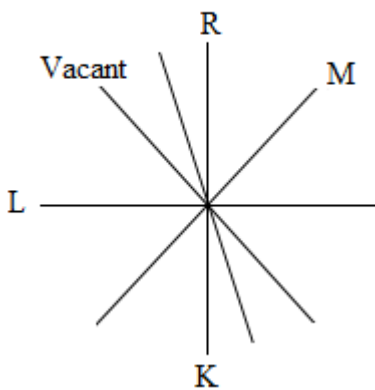

5. P sits immediate left of Q.
6. There are two persons between N and J
7. There are two people between P and N when counted to the left of N.

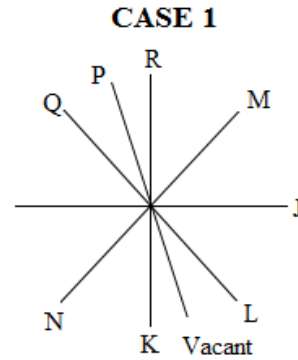

Here so many possibilities of Nas per condition we can place N at the immediate left of K

CASE 2

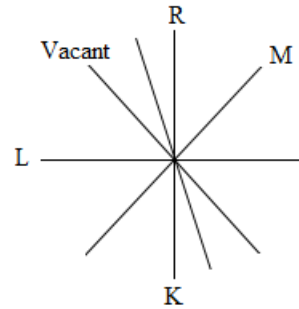

This case is eliminated as we can not place N, P and J

Final Arrangement

CASE 1

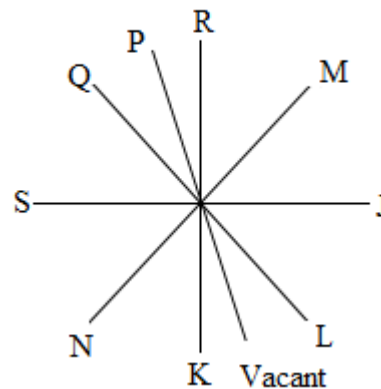

46.b

47.d

48.c

49.d

50.e

3. Square Seating

Directions (1-5): Study the following information carefully to answer the given question:

There are eight friends P, Q, R, S, T, U, V and W seating around a square table but not necessary in same order. They are seating in a way that person who seated at corner facing outside the centre and person who seated at middle of the side facing inside from the centre.

S sits third to the right of R. Only two persons sit between W and Q. V and W are immediate neighbors of S. P sits third right of V. T does not facing outside the centre. U is not the immediate neighbor of R. W does not sit opposite to R.

- 1. Who sits third to the right of R?**
 - (a) S
 - (b) T
 - (c) W
 - (d) P
 - (e) None of these
- 2. How many persons sit between P and W when counted to the left of P?**
 - (a) None
 - (b) One
 - (c) Two
 - (d) Three
 - (e) None of these
- 3. Which of the following person sits third to the left of Q?**
 - (a) U
 - (b) P
 - (c) R
 - (d) T
 - (e) None of these

4. If we change the direction of S who sits second to the right of S?

- (a) P
- (b) Q
- (c) R
- (d) T
- (e) U

5. Who sits opposite to the one who sits immediate left of T?

- (a) W
- (b) V
- (c) S
- (d) U
- (e) None of these

Directions (6-10): Study the following information carefully to answer the given question:

Eight friends namely –A, B, C, D, E, F, G and H are seated around a square table with two person seats on each of the sides. All of them are facing outside the centre. G sits fourth to the right of H. F is sitting to the immediate right of B. G is immediate neighbour of A and D. C is sitting opposite to A and to the immediate left of E.

6. Who sits fourth to right of B?

- (a) H
- (b) E
- (c) C
- (d) D
- (e) None of these.

7. Who sits immediate left of H?

Ultra Practice Bundle PDF for All Bank Prelims Exams

- (a) D
- (b) B
- (c) E
- (d) C
- (e) None of these

8. How many persons sit between B and E?

- (a) Four
- (b) One
- (c) Three
- (d) Five
- (e) Either (b) or (d)

9. Who sits to the immediate left of the person who sits second to the right of A?

- (a) G
- (b) D
- (c) H
- (d) E
- (e) None of these

10. Which of the following pairs are immediate neighbour?

- (a) F,E
- (b) F,D
- (c) F,C
- (d) C,D
- (e) None of these

Directions (11-15): Study the following information carefully to answer the given question:

Eight persons A, B, C, D, E, F, G and H are sitting around a square table facing centre but not necessarily in the same order. Four of them sits at corner and while others are sitting at middle of the sides. Each one of them has different Laptop such as Lenovo, Sony, Apple and HP. Not more than two persons have same mobiles.

B sits second to the right of A. Two persons sit between B and D. D and A are not immediate neighbours. Person sitting on opposite sides have same mobiles. B has HP Laptop and sits second to the left of C. The one who has Apple laptop does sit immediate right of the one who has

HP laptop. C and the one who has Lenovo laptop is immediate neighbour. E is an immediate neighbor of the one who has Sony Laptop and does not sits at corner of the table. One person sits between Apple laptop and G. H does not have Apple laptop.

11. Which of the following person have apple laptop?

- (a) E
- (b) H
- (c) C
- (d) D
- (e) None of these

12. How many persons sit between H and the one who has HP laptop?

- (a) One
- (b) Two
- (c) Three
- (d) Four
- (e) None of these

13. Which of the following does not sits at corner of the table?

- (a) H
- (b) A
- (c) B
- (d) C
- (e) D

14. A have which of the following laptop?

- (a) Lenovo
- (b) Sony
- (c) HP
- (d) Apple
- (e) None of these

15. Which of the following person sits fifth to the left of C?

- (a) A
- (b) C
- (c) D
- (d) G
- (e) None of these

Ultra Practice Bundle PDF for All Bank Prelims Exams

Directions (16-20): Study the following information carefully to answer the given question:

Eight persons R, A, V, G, D, J, M and S sitting in square table. Four of them sits at corner and while others are sitting at middle of the sides. The person who sits at corner facing towards centre and other faces outside. They all like different colours such as Pink, Green, Purple, Red, Black, Blue, Yellow and Orange not necessarily in the same order. R likes Blue colour. D sits immediate left of R. Only two persons were sitting between D and one who like Black colour. G sits immediate left of one who likes black colour. Only three persons were sitting between A and M. One who like orange colour sits third to the right of M and that is not J. J sits third to the left of one who like Black colour. Only one person was sitting between G and V. One who like Pink coloursits immediate right of the one who likes Red colour. D does not like Pink and the one who likes Pink does not sits at corner. J does not like green colour. One who like Green colour sits immediate left of one who like Yellow colour.

16. Which of the following person likes Orange?

- (a) V
- (b) S
- (c) D
- (d) Cannot be determined
- (e) None of these

17. Which of the following colour does M likes?

- (a) Blue
- (b) Green
- (c) Pink
- (d) Black
- (e) None of these

18. How many persons sit between D and the one who likes Yellow, when counted from right of D?

- (a) None
- (b) One
- (c) Two
- (d) Three
- (e) None of these

19. Which of the following person sits opposite to each other?

- (a) M, D
- (b) J, S
- (c) G, R
- (d) V, J
- (e) S, A

20. If J and A interchange their place, then who sits third to the left of J?

- (a) S
- (b) G
- (c) The one who likes Red
- (d) M
- (e) Both (c) and (d)

Directions (21-25): Study the following information carefully to answer the given question:

Eight persons P, Q, R, S, T, U, V and W are sitting around a square table in such a way that four of them sit at four corners, who are facing towards centre, and rest four who sits at the middle of the side, are facing outside. They have different ages in years i.e. 18, 5, 25, 49, 27, 16, 36 and 17.

P sits at the middle of the side and has age less than 20years. Only two persons sits between P and T. S's age is 25years sits second to the right of V. Difference between the ages of P's and the one who sits immediate left of P is one. V does not face inside. The one whose age is 36years sits second to the left of W. Only one person sits between U and Q whose age is 49years. The one whose age is an odd number greater than 20years sits third to the right of S. R's ages is even number. W sits third to the left of V. U's age is a prime number.

21. Who sits third to the left of the one whose age is 17years?

- (a) P
- (b) Q
- (c) R
- (d) S
- (e) T

Ultra Practice Bundle PDF for All Bank Prelims Exams

22. The age difference between V and P is how many years?

- (a) 12
- (b) 13
- (c) 14
- (d) 11
- (e) Either b or d

23. Which of the following combination is true?

- (a) T – 18years
- (b) W- 27years
- (c) S- 49years
- (d) V- 27years
- (e) U- 16years

24. Sum of the age of immediate neighbor of R is how many years?

- (a) 63
- (b) 65
- (c) 62
- (d) 61
- (e) 60

25. Which of the following person sit opposite to U?

- (a) V
- (b) Q
- (c) S
- (d) T
- (e) U

Directions (26-30): Study the following information carefully to answer the given question:

Twelve persons M, N, O, P, Q, R, S, T, U, V, W and X are seated around a square table facing the outside the centre. There was one person on each of the corners and two persons on each of the sides. S was 3rd to the right of Q who was seated at one of the corners. P was 2nd to the right of T who is opposite to N. N and V was seated at a gap of 3 persons. V is opposite to S's neighbor. O was to the immediate left of R. P was seated opposite to U's neighbor. W was 3rd to the right of X. W was seated opposite to M.

26. Which among the following person sitting middle of the table?

- (a) S
- (b) R
- (c) P
- (d) T
- (e) Q

27. What is the position of M with respect to X?

- (a) Second to the right.
- (b) Fourth to the right
- (c) Third to the right.
- (d) Third to the left.
- (e) None of these.

28. How many persons are sitting between W and R, when counted from left of R?

- (a) 2
- (b) 3
- (c) 4
- (d) 5
- (e) 6

29. Which of the following odd out of rest?

- (a) T, N
- (b) W, M
- (c) Q, P
- (d) V, O
- (e) S, R

30. Who sits third to the right of P?

- (a) Q
- (b) R
- (c) V
- (d) N
- (e) M

Directions (31-35): Study the following information carefully to answer the given question:

12 friends O, P, Q, R, S, T, U, V, W, X, Y and Z sitting around a square table facing the centre of the table. There was one person on each of the corners and two persons on each of the sides Q sits opposite to the person who sits adjacent to V. 2 people sit between O & P. P sits 2nd to the right of U who does not sits at corner of the table. S is not adjacent to P. Neither P nor V is adjacent to Z. U sits

Ultra Practice Bundle PDF for All Bank Prelims Exams

opposite to W who is to the immediate right of R. X is to the second to right of S and sits opposite to T. Y is not immediate neighbour of T. Y doesn't sit at any corner of the table

31. Who sits opposite to S?

- (a) Q
- (b) R
- (c) T
- (d) U
- (e) P

32. Which of the following sits fifth to the right of U?

- (a) Q
- (b) R
- (c) S
- (d) O
- (e) P

33. Which of the following statement is true?

- (a) Only two persons sit between V and U when counted clockwise direction from V.
- (b) Z and T are opposite to each other.
- (c) R sits immediate right of S.
- (d) X and Q are immediate neighbour
- (e) All are true

34. What is the position of W with respect to T?

- (a) W sits fourth to the right of T.
- (b) W sits fourth to the left of T.
- (c) W sits third to the right of T.
- (d) Both (a) and (b)
- (e) None of these.

35. If O and X interchange the positions then who faces O?

- (a) P
- (b) Q
- (c) R
- (d) S
- (e) T

Directions (36-40): Study the following information carefully to answer the given question:

J, W, O, V, P, U, H and G are sitting around a square table in such a way that four of them sit at four corners of the square while four sit in the middle of each of the four sides. The ones who sit at the four corners face the outside while those who sit in the middle of the sides face inside. Four of them are males and rests are females. Two males

sit in the middle of the sides and two at the corners. J sits second to the right of H. H sits in the corner of the table. O sits fourth to the left of her husband and her husband is not an immediate neighbour of J. W sits third to left of his wife. W does not sit at any of the sides. V sits adjacent to both W and G. G is the wife of J. P is a female. P and U are not sitting opposite to each other.

36. Who is husband of O?

- (a) U
- (b) G
- (c) V
- (d) W
- (e) None of these

37. What is the position of W with respect to his wife?

- (a) Immediate right
- (b) Second to the right
- (c) Second to the left
- (d) Immediate left
- (e) None of these

38. Which of the following person are immediate neighbor of O?

- (a) W, J
- (b) W, G
- (c) U, H
- (d) G, O
- (e) None of these

39. How many person sit between G and J?

- (a) 1
- (b) 2
- (c) 3
- (d) 4
- (e) None of these

40. Who sits third to the right of G?

- (a) J
- (b) P
- (c) V
- (d) W
- (e) None of these

Directions (41-45): Study the following information carefully to answer the given question:

8 friends P, Q, R, S, T, U, V and W sits around a square table. 4 of them sits at four corners & 4 of them sits at the centre of each side. Not more than 2 people facing the same direction sits together. P sits 3rd to the right of S who

Ultra Practice Bundle PDF for All Bank Prelims Exams

faces outside the centre. One person sits between P & R. Immediate neighbors of W face the opposite direction. Q sits at middle. T & U are immediate neighbours & both faces opposite direction. W faces outside the table & is not an immediate neighbor of S. Two people are sitting between R and V, who is facing outside the table. S & V don't have three people in between them. V is not immediate neighbor of either T or U also not opposite to T.

41. Who is to the immediate right of V?

- (a) Q
- (b) R
- (c) S
- (d) T
- (e) None of these

42. Who is to the third to the right of Q ?

- (a) S
- (b) U
- (c) P
- (d) T
- (e) None of these

43. Who is to the immediate left of U?

- (a) P
- (b) W
- (c) T
- (d) R
- (e) Data inadequate

44. Who sits opposite to T?

- (a) W
- (b) V
- (c) S
- (d) Q
- (e) None of these

45. If we change the direction of V then who is third to the left of V?

- (a) T
- (b) S

- (c) W
- (d) V
- (e) R

Directions (46-50): Study the following information carefully to answer the given question:

Eight persons are sitting in two square tables, 1 table is inner side of another table. 4 persons are sitting on each table. The persons who sit in inner side of the table sit in the middle side and faces outside the center and the persons who sit on outer side of the square sit in the middle and faces inside. E sits second to the right of C who is not an immediate neighbor of G, who sits immediate left of F. H does not sit with F. B is to immediate right of C. G and A faces each other. D does not sit at outer table.

46. Who sits to the immediate left of H?

- (a) E
- (b) A
- (c) D
- (d) F
- (e) B

47. Who sits second to the left of B ?

- (a) B
- (b) D
- (c) H
- (d) F
- (e) A

48. Who is second to the right of E?

- (a) G
- (b) A
- (c) C
- (d) E
- (e) H

49. How many persons sit between B and C, when counted from left of B?

- (a) One
- (b) Four
- (c) No one



Ultra Practice Bundle PDF for All Bank Prelims Exams

- (d) Two
- (e) Three

50. What is the position of E with respect to B?

- (a) Third to the right
- (b) Second to the right
- (c) Third to the left
- (d) Second to the left
- (e) None of these

Solution and Detailed Explanation

SOLUTION (1-5):

- 20. S sits third to the right of R
- 21. V and W are immediate neighbors of S.
- 22. W does not sit opposite to R.

CASE 1

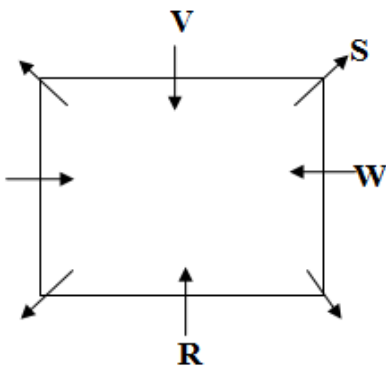

CASE 2

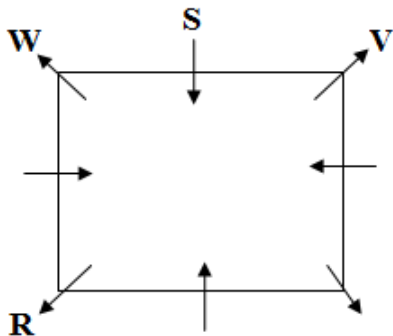

- 23. Only two persons sit between W and Q.
- 24. P sits third right of V

CASE 1

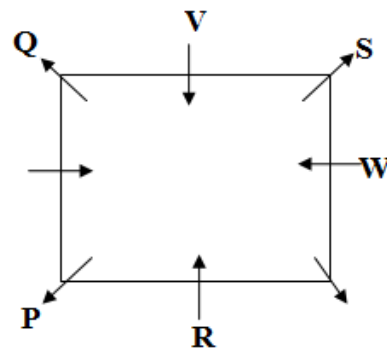

CASE 2

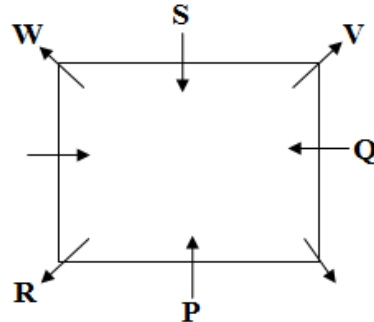

- 25. T does not facing outside the centre.
- 26. U is not the immediate neighbor of R.

CASE 1

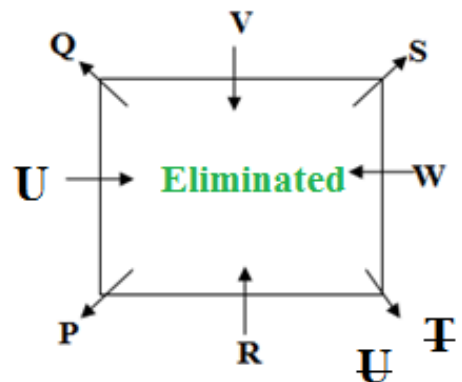



Ultra Practice Bundle PDF for All Bank Prelims Exams

Case-1 gets eliminated since T is not facing outside the centre.

Final Arrangement

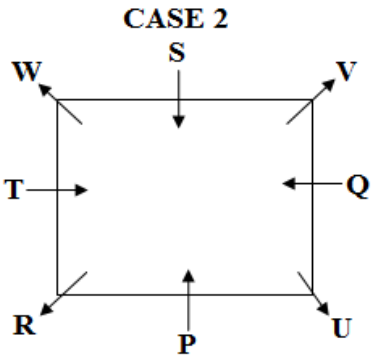

- 1.a
- 2.c
- 3.c
- 4.b
- 5. d

SOLUTION (6-10):

- 1. G sits fourth to the right of H
- 2. A is immediate neighbour of G and D.

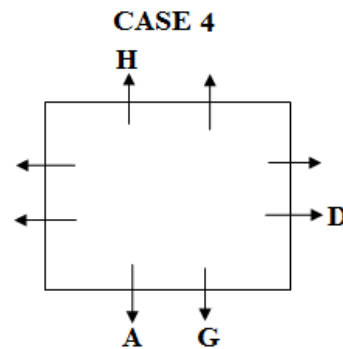
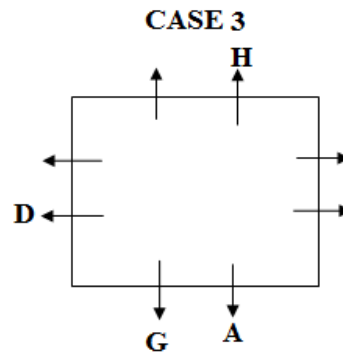
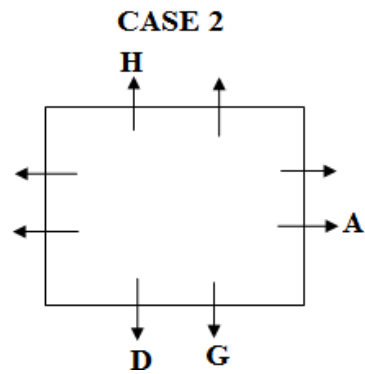
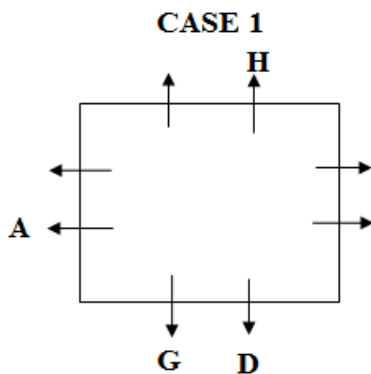

- 3. C is sitting opposite to A and to the immediate left of E.

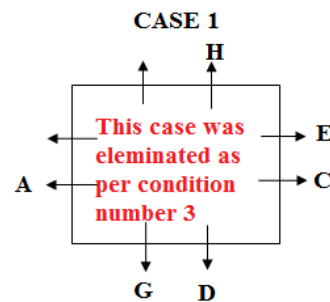



Ultra Practice Bundle PDF for All Bank Prelims Exams

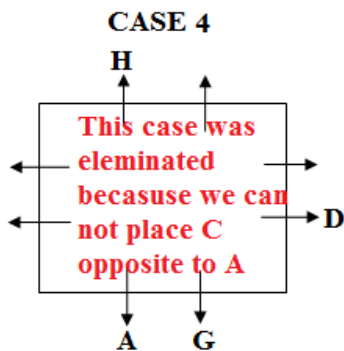
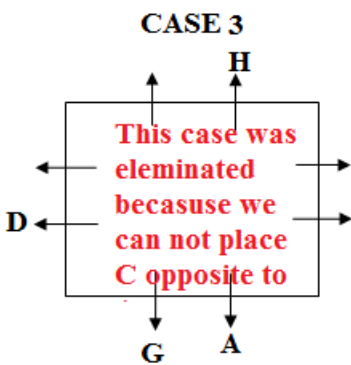
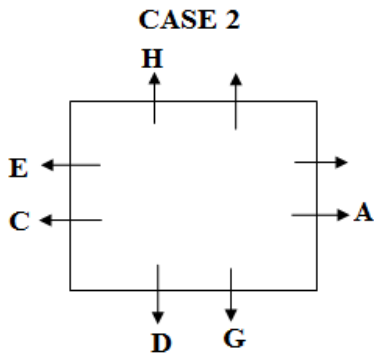

4. F is sitting to the immediate right of B.

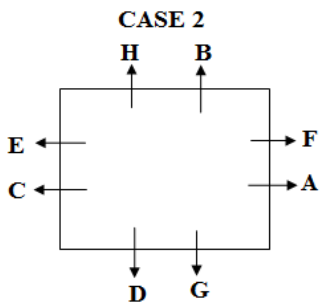

Final Arrangements

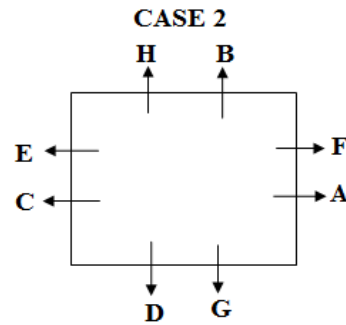

6.d

7.c

8.e

9.a

10.d

SOLUTION (11-15):

1. B sits second to the right of A.
2. Two persons sit between B and D.
3. D and A are not immediate neighbours.
4. B has HP Laptop and sits second to the left of C.
5. Person sitting on opposite sides have same mobiles (It means HP laptop are opposite)

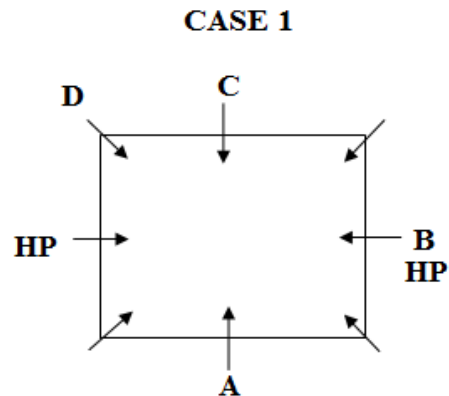



Ultra Practice Bundle PDF for All Bank Prelims Exams

CASE 2

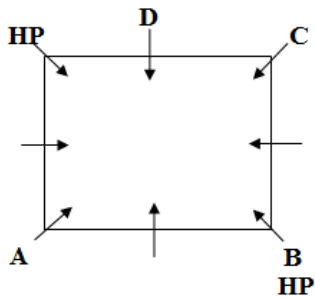

- 6. The one who has Apple laptop does sit immediate right of the one who has HP laptop
- 7. C and the one who has Lenovo laptop is immediate neighbour.
- 8. Person sitting on opposite sides have same mobiles

CASE 1

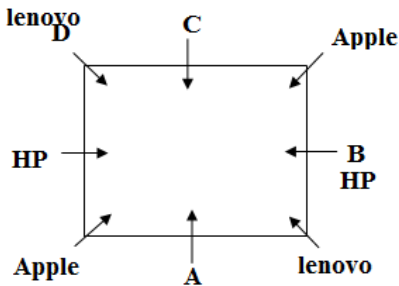

CASE 2

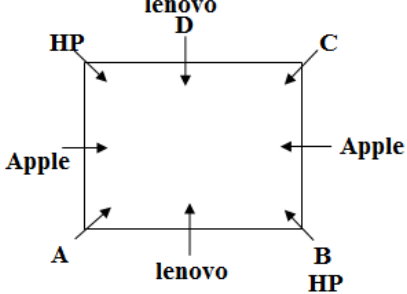

- 9. One person sits between Apple laptop and G.
- 10. E is an immediate neighbor of the one who has Sony Laptop and does not sits at corner of the table.

CASE 1

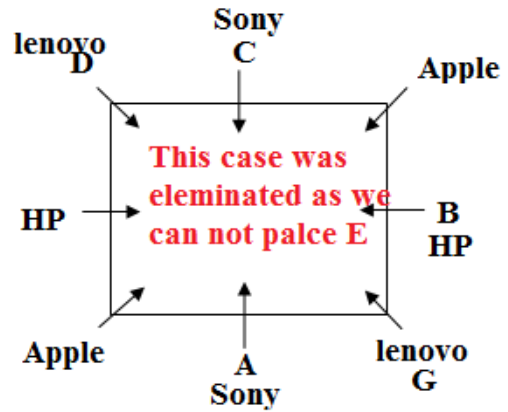

CASE 2

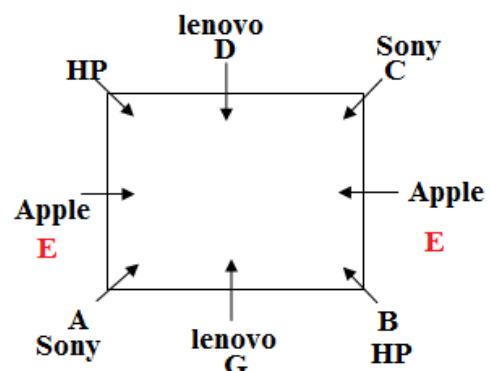

11. H does not have Apple laptop

CASE 2

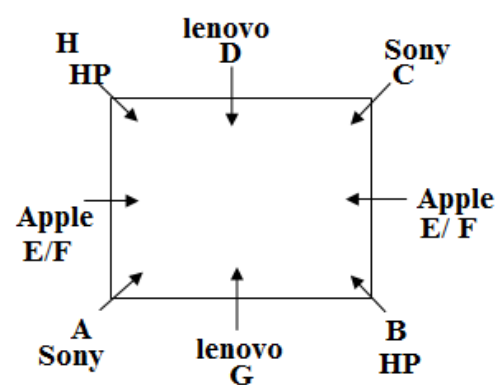

Final Arrangements



Ultra Practice Bundle PDF for All Bank Prelims Exams

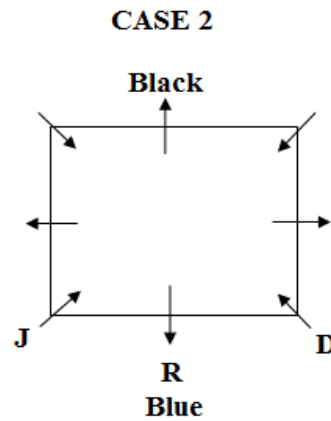
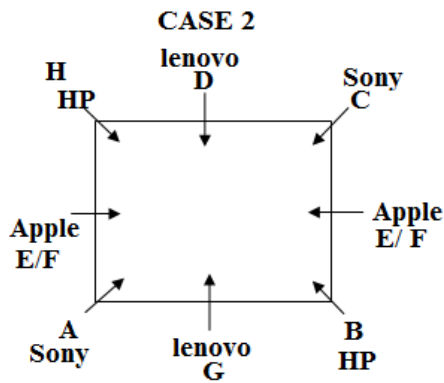

- 11.a
- 12.c
- 13.e
- 14.b
- 15.e

SOLUTION (16-20):

1. R likes Blue colour.
2. D sits immediate left of R.
3. Only two persons were sitting between D and one who like Black colour.
4. J sits third to the left of one who like Black colour

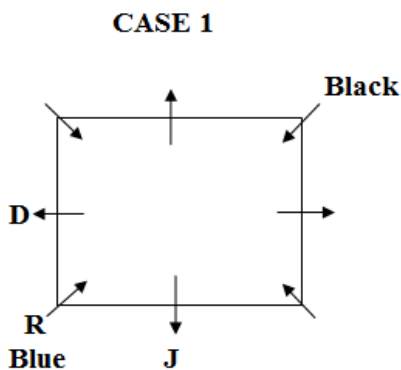

5. G sits immediate left of one who likes black colour.
6. Only one person was sitting between G and V.
7. Only three persons were sitting between A and M.
8. One who like orange colour sits third to the right of M and that is not J

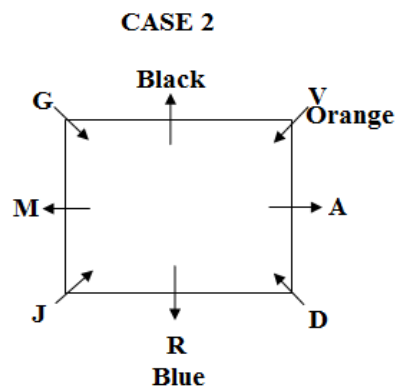
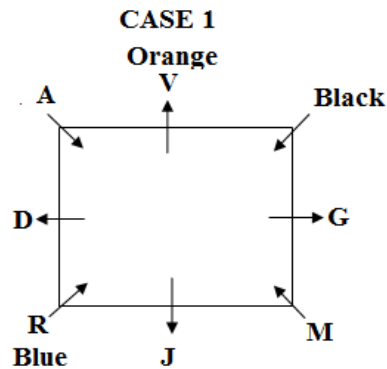

9. J does not like green colour.
10. One who like Green colour sits immediate left of one who like Yellow colour.



Ultra Practice Bundle PDF for All Bank Prelims Exams

CASE 1

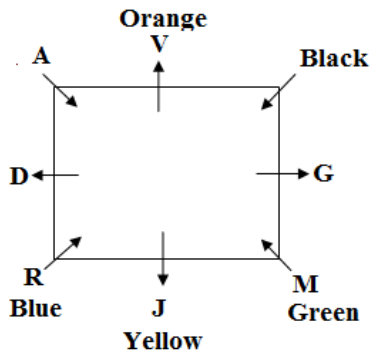

CASE 2

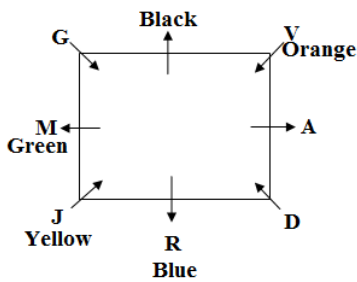

- 11. One who like Pink colour sits immediate right of the one who likes Red colour.
- 12. D does not like Pink and the one who likes Pink does not sits at corner.

CASE 1

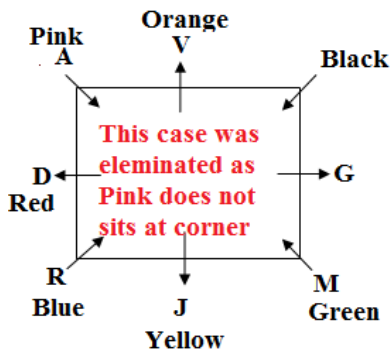

13.

CASE 2

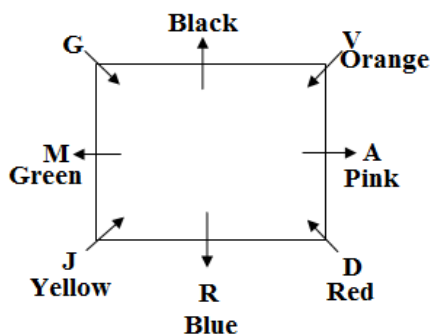

Final Arrangements

CASE 2

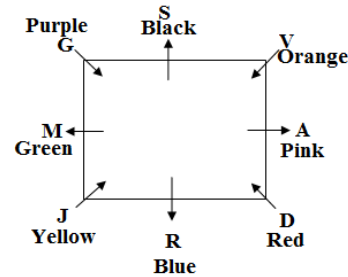

- 16.a
- 17.b
- 18.e
- 19.d
- 20.b

SOLUTION (21-25):

- 1. V does not face inside
- 2. S's age is 25years sits second to the right of V.
- 3. W sits third to the left of V.
- 4. The one whose age is 36years sits second to the left of W.

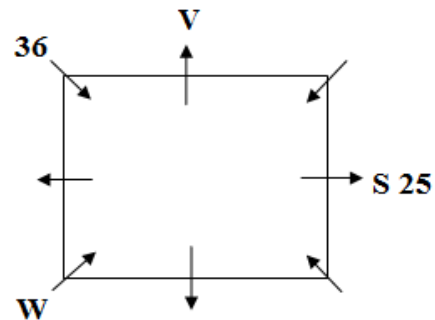

- 5. P sits at the middle of the side
- 6. Only two persons sits between P and T.
- 7. The one whose age is an odd number greater than 20years sits third to the right of S.

Here W's age is 49 not Possible because Q age is 49



Ultra Practice Bundle PDF for All Bank Prelims Exams

CASE 1

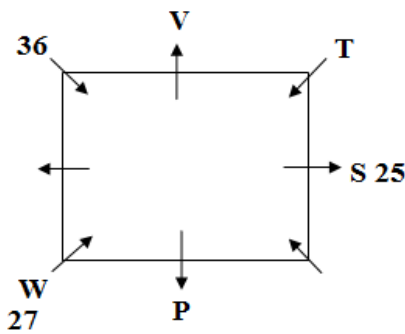

CASE 2

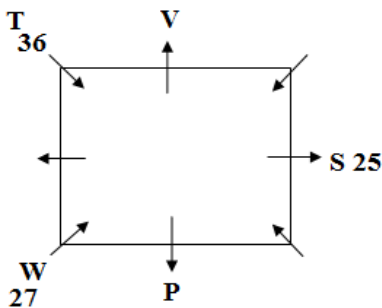

CASE 2

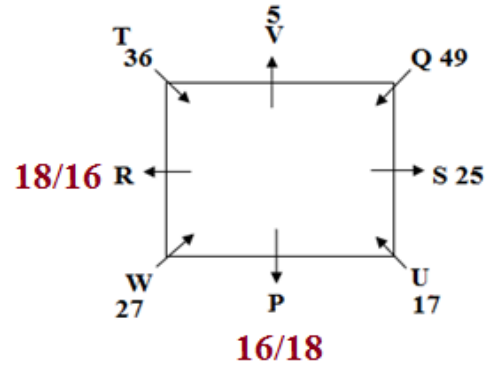

Final Arrangements

CASE 2

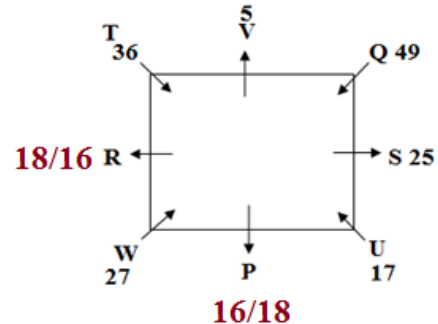

- 8. Difference between the ages of P's and the one who sits immediate left of P is one.
- 9. Only one person sits between U and Q whose age is 49 years.
- 10. R's ages is even number (here only 18 year is left)
- 11. U's age is a prime number.

Here we can fix U and Q and age of P and U is either 16 or 17 only as per condition 8

CASE 1

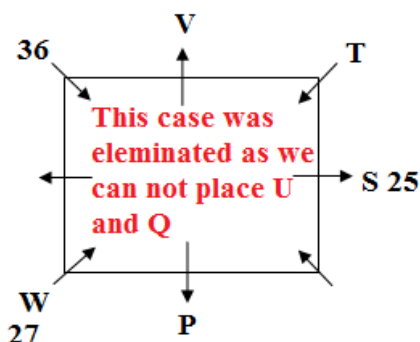

- 21.c
- 22.e
- 23.b
- 24.a
- 25.d

SOLUTION (26-30):

- 1. S was 3rd to the right of Q who was seated at one of the corners
- 2. V is opposite to S's neighbour.



Ultra Practice Bundle PDF for All Bank Prelims Exams

CASE 1

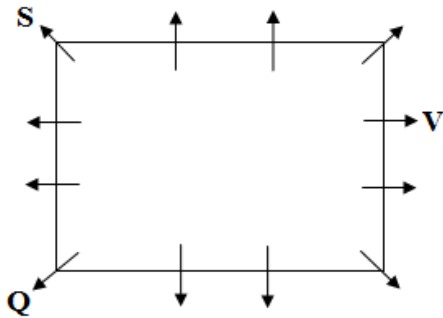

CASE 2

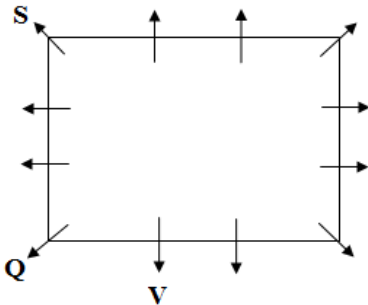

- 3. N and V was seated at a gap of 3 persons.
- 4. P was 2nd to the right of T who is opposite to N.

CASE 1

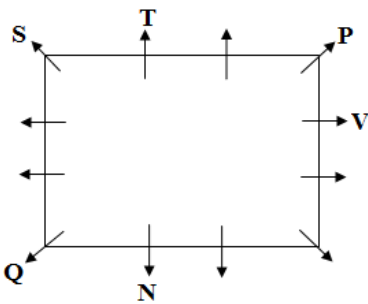

CASE 2

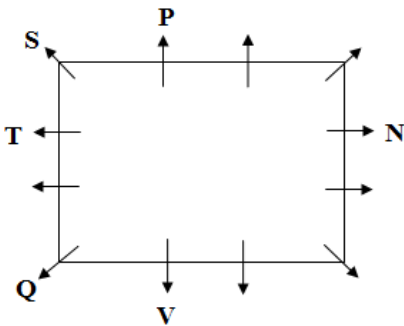

- 5. P was seated opposite to U's neighbor.

- 6. W was seated opposite to M.
- 7. O was to the immediate left of R

CASE 1

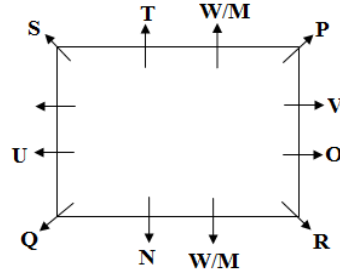

CASE 2

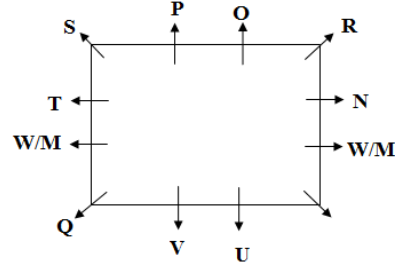

- 8. W was 3rd to the right of X.

CASE 1

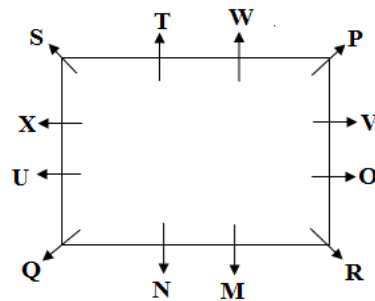

CASE 2

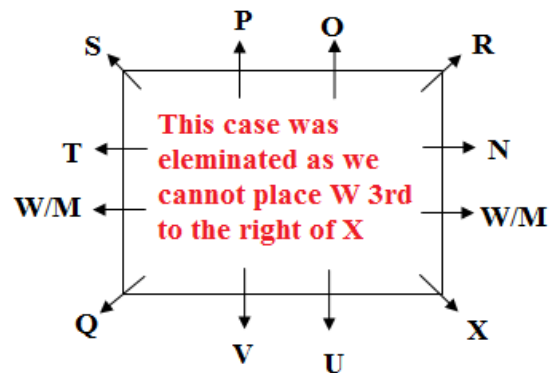

Final Arrangement



Ultra Practice Bundle PDF for All Bank Prelims Exams

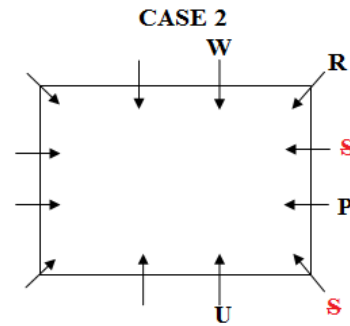
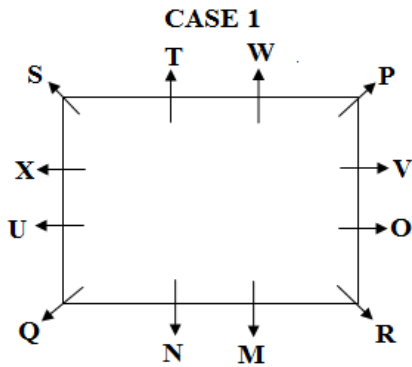

26.d

27.e(4th)

28.b

29.d

30.b

4. X is to the second to right of S and sits opposite to T.

SOLUTION (31-35):

1. P sits 2nd to the right of U who does not sit at corner of the table.
2. S is not adjacent to P.
3. U sits opposite to W who is to the immediate right of R.

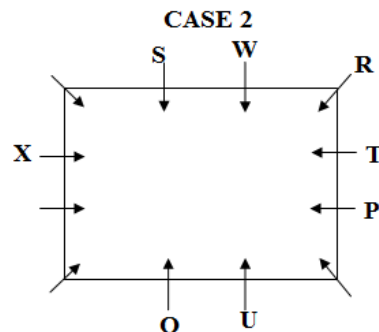
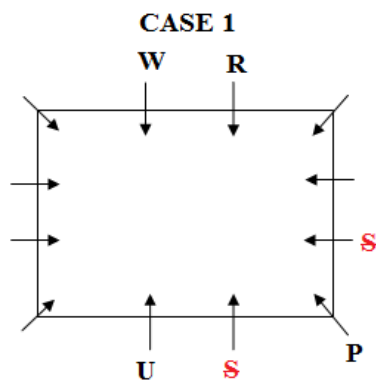
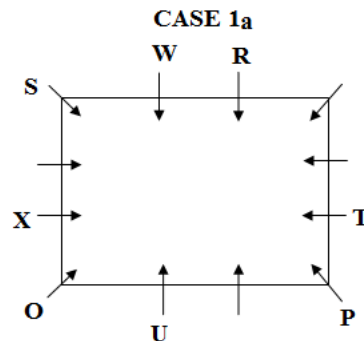
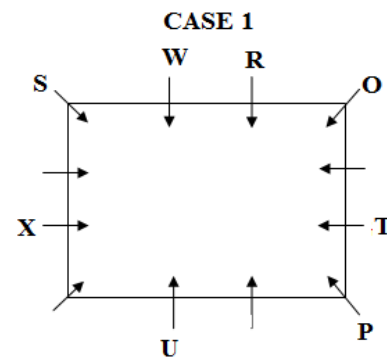

5. Q sits opposite to the person who sits adjacent to V.



Ultra Practice Bundle PDF for All Bank Prelims Exams

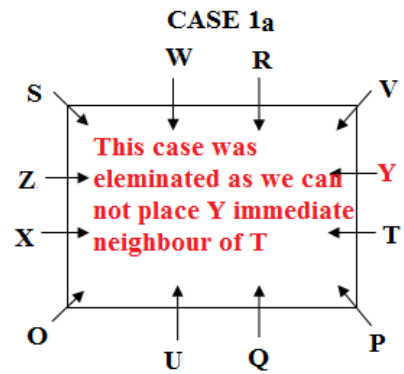
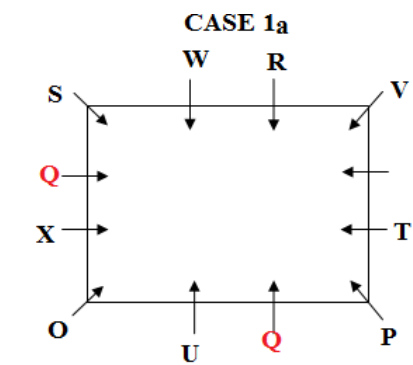
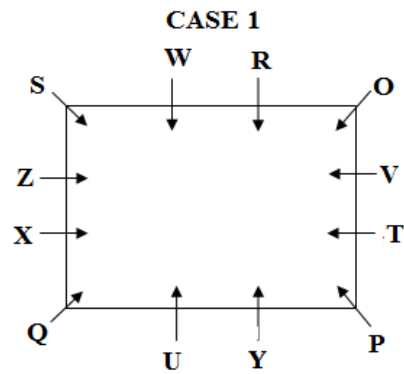
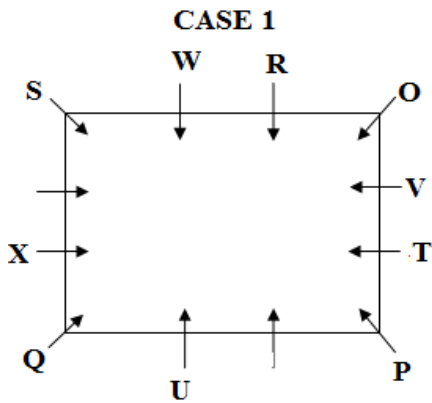

Final Arrangements

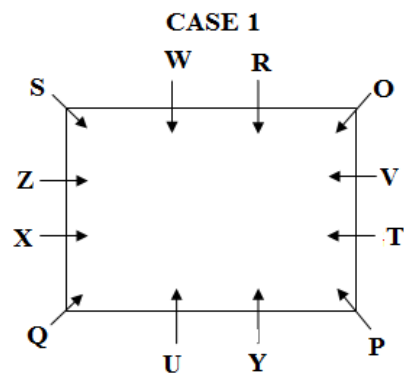
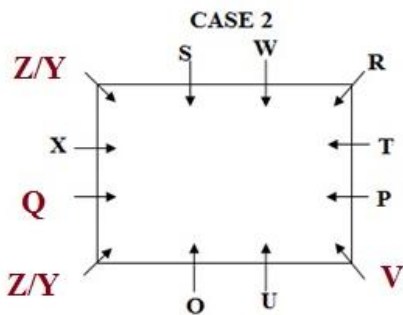

- 6. Neither P nor V is adjacent to Z
- 7. Y is not immediate neighbour of T.
- 8. Y doesn't sit at any corner of the table

With the condition (8) case-2 arrangement gets eliminated

31.e

32.d

33.d

34.a

35.e

SOLUTION (36-40):



Ultra Practice Bundle PDF for All Bank Prelims Exams

1. J sits second to the right of H.
2. H sits in the corner.
3. W sits third to left of his wife.
4. W does not sit at any of the sides.

CASE 1

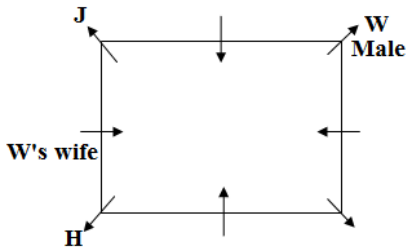

CSAE 2
W's wife

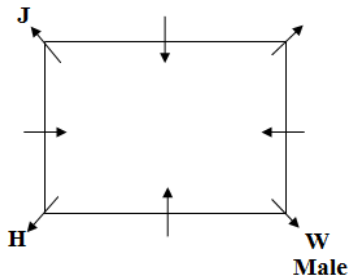

5. V sits adjacent to both W and G
6. G is the wife of J.

J = G

CASE 1

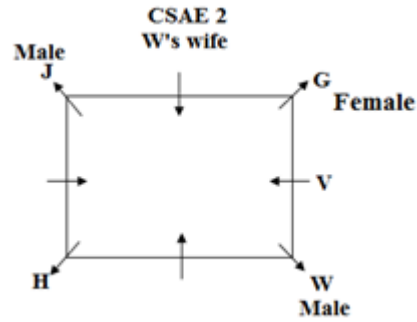
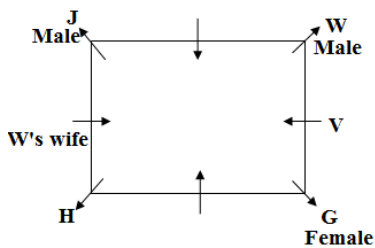

7. O sits fourth to the left of her husband and her husband is not an immediate neighbour of J.
8. Two males sit in the middle of the sides and two at the corners.

CASE 1

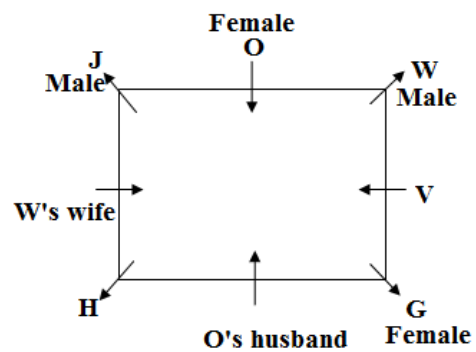

CSAE 2

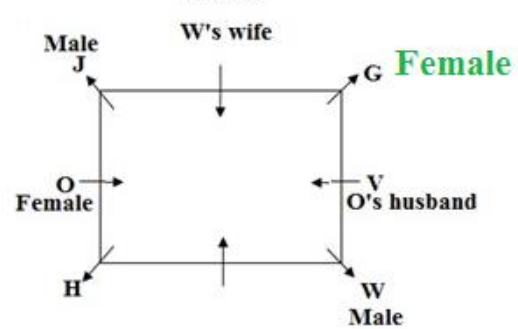

9. P is a female.
10. P and U are not sitting opposite to each other

Case-2 gets eliminated since P and U are not sitting opposite to each other.

O = U



Ultra Practice Bundle PDF for All Bank Prelims Exams

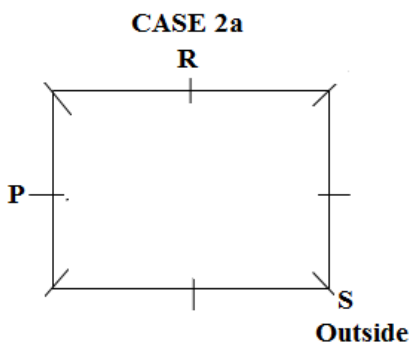
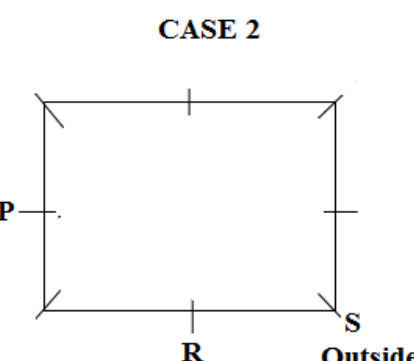
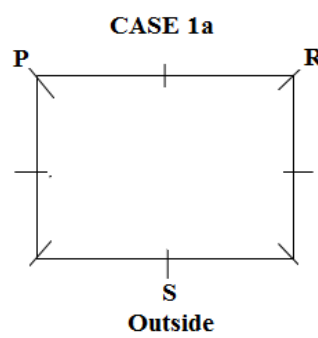
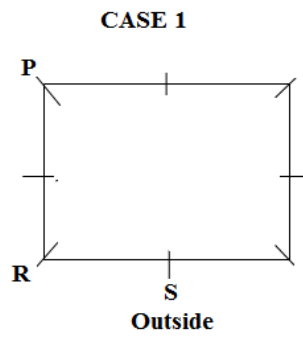
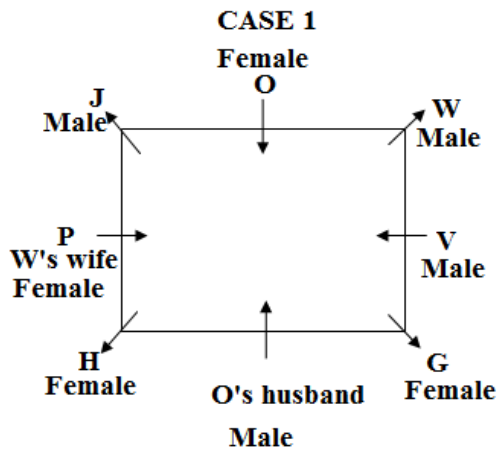

Final Arrangement

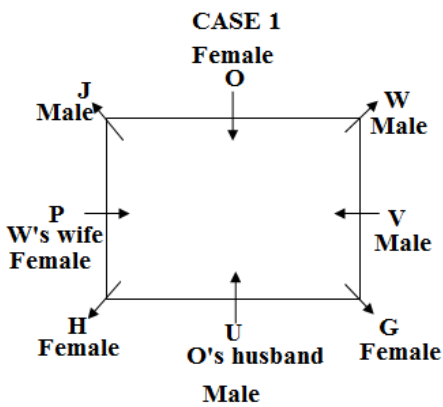

36.a

37.e (3rd left)

38.a

39.c

40.b

SOLUTION (41-45):

1. P sits 3rd to the right of S who faces towards the outside the centre.
2. One person sits between P & R.

3. Two people are sitting between R and V, who is facing outside the table.
4. E sits second to the right of C who is not an immediate neighbor of G.
5. S & V don't have three people in between them.
6. Not more than 2 people facing the same direction sits together



Ultra Practice Bundle PDF for All Bank Prelims Exams

Here we can not place S and V opposite to each other as per condition number 5

CASE 1

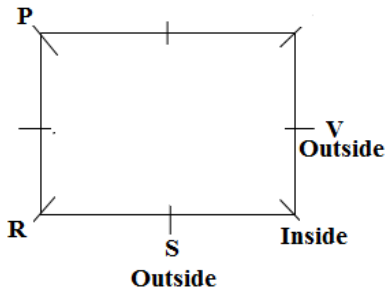

CASE 1a

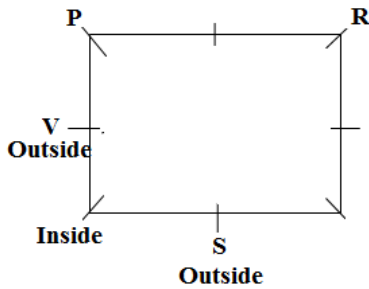

CASE 2

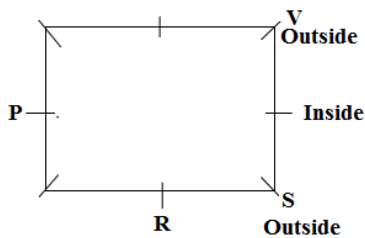

CASE 2a

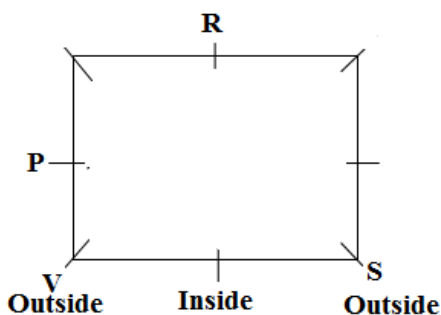

- 7. T & U are immediate neighbours.
- 8. V is not immediate neighbor of either T or U also not opposite to T.
- 9. W faces outside the table & is not an immediate neighbor of S.

CASE 1

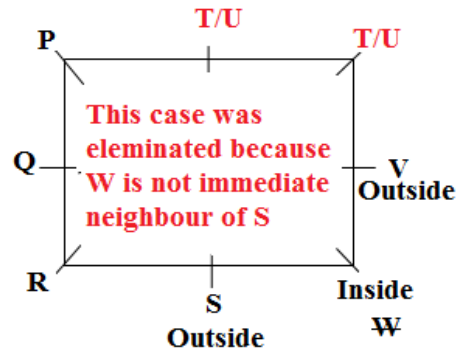

CASE 1a

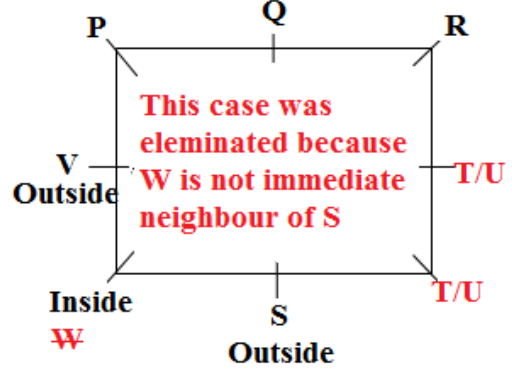

CASE 2

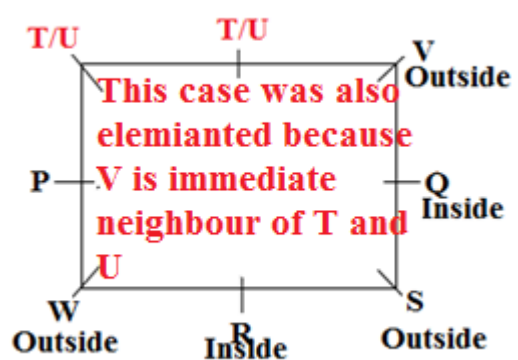



Ultra Practice Bundle PDF for All Bank Prelims Exams

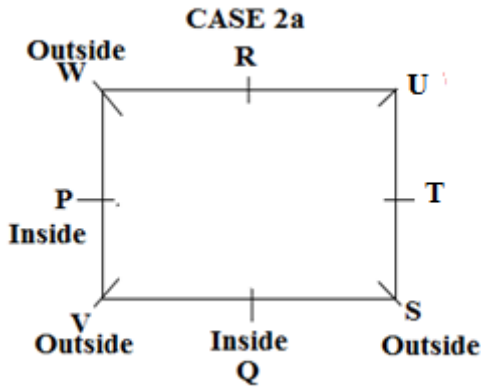

- 10. Immediate neighbors of W face the opposite direction.
- 11. T and U both face opposite direction
- 12. Not more than 2 people facing the same direction sits together.

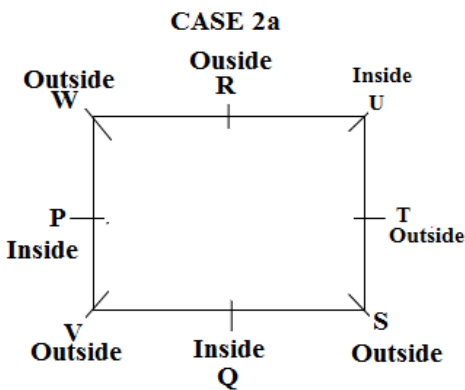

Final Arrangement

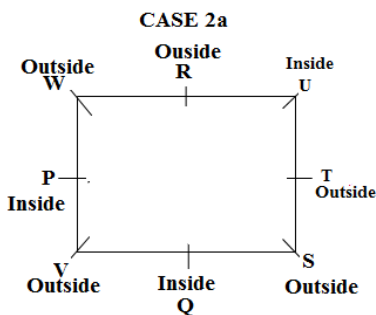

41.e(P)

42.b

43.c

44.e(P)

45.e

SOLUTION (46-50):

- 1. E sits second to the right of C who is not an immediate neighbor of G.
- 2. B is to immediate right of C

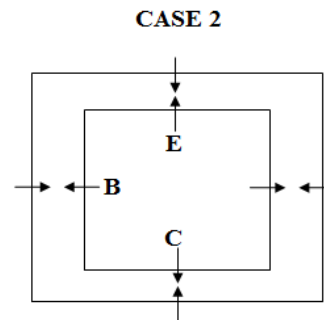
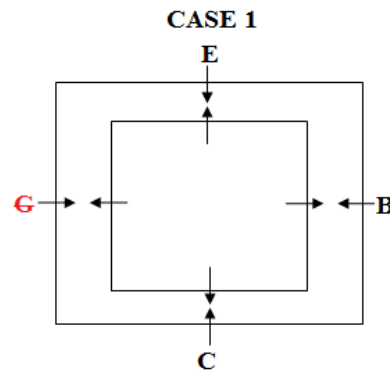

- 3. G and A faces each other.
- 4. G sits immediate left of F.
- 5. H does not sit with F

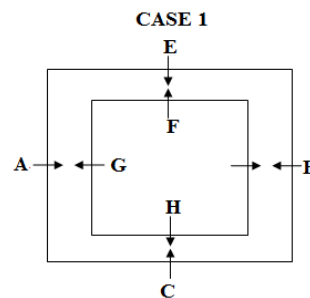



Ultra Practice Bundle PDF for All Bank Prelims Exams

CASE 2

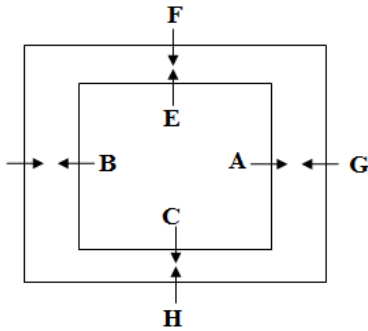

6. D does not sit at outer table.

CASE 1

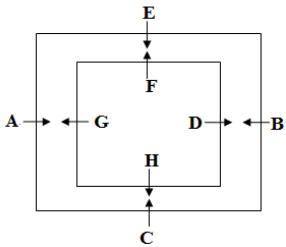

CASE 2

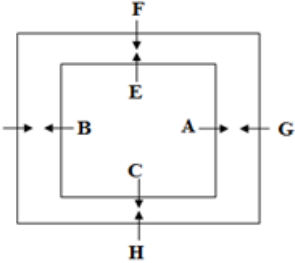

Tis case was eliminated as D is not sits at outer table

Final Arrangement

CASE 1

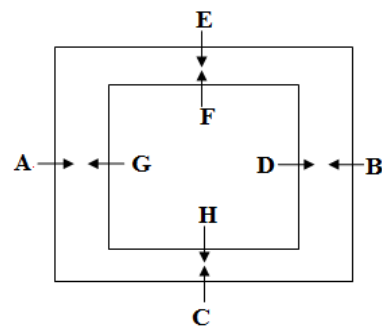

46.c

47.e

48.c

49.c

50.e(Immediate neighbour)

7.Blood Relation

Direction (1-3): Read the following information carefully to answer the question that follows:

There are seven members P, Q, R, S, T, U and V in a family.

R is father-in-law of U, who is grandmother of V. P has two sons. T is father of S. The gender of S and Q is same. R is married to P.

1) Who is mother of Q?

a. R

Ultra Practice Bundle PDF for All Bank Prelims Exams

- b. U
- c. P
- d. S
- e. None of these

2) How is V related to T?

- a. Grandson
- b. Grandfather
- c. Mother
- d. Granddaughter
- e. Cannot be determined

3) How is Q related to U?

- a. Brother
- b. Brother-in-law
- c. Sister-in-law
- d. Father
- e. None of these

Direction (4-6): Read the following information carefully to answer the question that follows:

There are six members P, Q, R, S, T and U in the family of three generations. There is no single parent in the family. U is aunt of T. R is mother-in-law of S's husband. Q has only one child. S and Q are not married to each other.

4) How is U related to S?

- a. Daughter
- b. Sister-in-law
- c. Sister
- d. Mother

- e. Daughter-in-law

5) Who is the father of S?

- a. Can't be determined
- b. P
- c. Q
- d. T
- e. None of these.

6) How R is related to T?

- a. Daughter
- b. Father
- c. Grandmother
- d. Sister
- e. None of these.

Direction (7-9): Read the following information carefully and answer the question that follow:

A, B, C, D, E, F, and H are family members related to each other. A is the father of D who is the brother of F. E is the husband of H. F is the sister of E. B is the son of D and husband of C.

7) How is E related to B?

- a. Brother-in-law
- b. Father-in-law
- c. Brother
- d. Uncle
- e. Father

8) How is H related to F?

- a. Sister-in-law
- b. Sister

Ultra Practice Bundle PDF for All Bank Prelims Exams

- c. Mother
- d. Mother-in-law
- e. Aunt

9) Who is the grandson of A?

- a. D
- b. F
- c. E
- d. C
- e. B

Direction (10-12): These questions are based on the following information.

A family consist of six members A, B, C, D, E and F. B is the son of C but C is not the mother of B. E is the brother of C. D is the daughter of A. F is the brother of A. A and C are married couple.

10) Who is the brother in law of C?

- a. A
- b. B
- c. D
- d. E
- e. F

11) How many females are there in the family?

- a. 1
- b. 2
- c. 3
- d. 4
- e. None of these

12) How is F related to B?

- a. Maternal Uncle
- b. Brother
- c. Daughter
- d. Paternal Uncle
- e. Aunt

Direction (13-15): Read the following information carefully to answer the question that follows:

There are five members P, Q, R, S and T in the family of three generations. No single parent has a child. R is father-in-law of T. S is son of Q, who is not married to R. P's and Q's gender is same.

13) Who is mother of Q?

- a. R
- b. P
- c. T
- d. Cannot be determined
- e. None of these

14) How is S related to T?

- a. Daughter
- b. Son-in-law
- c. Son
- d. Father
- e. None of these

15) How is P related to S?

- a. Granddaughter
- b. Son-in-law

Ultra Practice Bundle PDF for All Bank Prelims Exams

- c. Grandmother
- d. Grandfather
- e. None of these

Directions (16-17): Study the information given below carefully and answer the questions that follow.

At a coffee shop, there are 5 members present – P, Q, R, S and T. R is the daughter of Q and her son is T. There are two couples present at the gathering. T's father is sitting next to P who is a male. R's parents are present in the gathering. T is not married.

16) Who is S in this gathering?

- a. Q's husband
- b. R's husband
- c. T's son
- d. Q's son
- e. Cannot be determined

17) Who is S's father-in-law?

- a. Q
- b. P
- c. T
- d. R
- e. Cannot be determined

Direction (18-20): Read the following information carefully to answer the question that follows:

There are seven members P, Q, R, S, U, V and W in a family in which married couples are in 1st and 2nd generation. There is no single parent in the family.

U is the only daughter of Q, who has three children. W is the only sister in law of U. P is the grandfather of S, whose father is V's brother.

18) How is S related to U?

- a. Son
- b. Nephew
- c. Niece
- d. Can't be determined.
- e. None of these

19) How is W related to P?

- a. Daughter
- b. Niece
- c. Daughter in law
- d. Can't be determined
- e. None of these

20) How V related to Q?

- a. Brother
- b. Son
- c. Daughter
- d. Father
- e. Sister

Directions (21-23): Answer the questions based on the information given below.

There are seven members P, Q, R, S, T, U and V in the family of three generations. There is couple in each generation. Q is daughter-in-law of P, who has two

Ultra Practice Bundle PDF for All Bank Prelims Exams

children. U is the son of R and does not have any sibling. U is married to V. S is not married. There is no single parent in the family.

21) How is T related to R if P is a female?

- a. Father
- b. Mother
- c. Son-in-law
- d. Sister-in-law
- e. None of these

22) How is U related to S?

- a. Uncle
- b. Sister
- c. Niece
- d. Nephew
- e. None of these

23) How R is related to V?

- a. Father
- b. Mother
- c. Son-in-law
- d. Sister-in-law
- e. None of these

Directions (24-26): Answer the questions based on the information given below.

There are six members A, B, C, D, E and F in the family of three generations. There is equal number of males and females. No single parent has a child. F is father of A, who is married to D. B is grandmother of C. B has two children. E and D have same gender.

24) How is E related to D if A is a female?

- a. Sister-in-law
- b. Mother
- c. Father
- d. Brother-in-law
- e. None of these

25) How is B related to D?

- a. Mother-in-law
- b. Mother
- c. Sibling
- d. Nephew
- e. None of these

26) How F related to E?

- a. Father
- b. Mother
- c. Sibling
- d. Nephew
- e. None of these

Direction (27-30): These questions are based on the following information.

A, B, C, D, E, F, G, H, I and J are 10 family members living together. There are three couples living together with two children each.

C and D are brothers while C is brother-in-law of E. B is mother-in-law of F. G and H are sons of E and F respectively. I and J are grand-children of A. J is not H's sibling and I is not j's sibling. E has one daughter.

27) Who is B in the house?

- a. A's wife
- b. C's mother

Ultra Practice Bundle PDF for All Bank Prelims Exams

- c. E's mother-in-law
- d. G's grand-mother
- e. All of these

28) What is the relation between I and H?

- a. Brothers
- b. Sisters
- c. Either brothers or brother-sister
- d. Neither brothers nor brother-sister
- e. Can't be determined

29) Who is J's father?

- a. A
- b. C
- c. D
- d. G
- e. None of these

30) Who is E's father-in-law?

- a. A
- b. C
- c. B
- d. D
- e. G

Direction (31-32): Study the information given below carefully and answer the questions that follow.

There are eight members in a family – A, B, C, D, E, F, G and H. A is grandmother of G who is the cousin of H. A is married to B. B has one son and one daughter. C who is the son of A is married to E. F is the wife of D. H is the son of D and nephew of C. E has one son.

31) How is H related to B?

- a. Grandson
- b. Son
- c. Brother-in-law
- d. Son-in-law
- e. Cannot be determined

32) How is F related to B?

- a. Son
- b. Daughter
- c. Mother
- d. Sister
- e. Daughter-in-law

Directions (33-35): Study the following information and answer the questions given below.

There are eight members in a family namely A, B, C, D, E, F, G and H are going to fair in their village. In this family there is a married couple. B is son of C. G, C's sister, has two daughters. H is maternal uncle of G's daughters. A is father of D, who is sister to B.

33) How is E related to D?

- a. Niece
- b. Nephew
- c. Cousin
- d. Sister-in-law
- e. None of these

34) Which of the following is a married couple?

- a. GB
- b. AC

Ultra Practice Bundle PDF for All Bank Prelims Exams

- c. HC
- d. Can't be determined
- e. None of these

35) How is H related to D?

- a. Paternal Uncle
- b. Niece.
- c. Maternal Uncle.
- d. Data Inadequate.
- e. None of these.

Directions (36-38): Study the following information carefully and answer the questions given below.

A, B, C, D, E, F, G, H, I and J are the ten people in a family. B is the brother of H, who is the only daughter of A. J is the only daughter of I, who is married to the only son of D. C is the son-in-law of D, who is the father of B. G is the paternal Grandmother of E, who is the sister of F.

36) How is J related to D?

- a. Father
- b. Mother
- c. Grandson
- d. Granddaughter
- e. Cousin sister

37) How is F related to G?

- a. Son
- b. Daughter
- c. Grandson
- d. Granddaughter
- e. Can't be determined

38) How is H related to J?

- a. Sister
- b. Brother
- c. Aunt
- d. Mother
- e. Father

Directions (39-41): Answer the questions based on the information given below.

There are eight members, A through H in a family. There is no single parent in the family.

F's mother's only brother's father is B. E is the only brother-in-law of H. D's mother is the only daughter-in-law of B. Number of males is more than the number of females. G is the only daughter of A. E has a sibling.

39) How is E related to F?

- a. Father
- b. Uncle
- c. Brother
- d. Either (a) or (b)
- e. None of these

40) How is F related to B?

- a. Grandson
- b. Granddaughter
- c. Son
- d. Daughter
- e. None of these

41) How is G related to H?

- a. Sister

Ultra Practice Bundle PDF for All Bank Prelims Exams

- b. Wife
- c. Aunt
- d. Cannot be determined
- e. None of these

Directions (42-44): These questions are based on the following information.

In a family, there are eight members. Four men Ram, Shyam, Mohan and Sohan and four women Sita, Geeta, Sangeeta and Meeta. Sangeeta has two married sons and one married daughter. Ram is Mohan's son-in-law. Geeta is Shyam's sister. Sita is not Sohan's wife.

42) Who are the two daughter-in-laws of Mohan?

- a. Sita and Geeta
- b. Sita and Meeta
- c. Geeta and Meeta
- d. Sangeeta and Sita
- e. Sangeeta and Meeta

43) Who is Sohan's wife?

- a. Sita
- b. Geeta
- c. Meeta
- d. Sangeeta
- e. Either Meeta or Sita

44) Which of the following is not a correct pair of wife and husband?

- a. Sangeeta and Mohan
- b. Meeta and Sohan
- c. Sita and Shyam
- d. Geeta and Ram

- e. Shyam and Meeta

Directions(45-47): Answer the questions based on the information given below.

There are seven members, A, B, C, D, E, F and G in a family. There is no single parent in the family. G's father's only sister's only daughter in law is F. A is the only brother-in-law of D, who is a male member. E is the only sister-in-law of B.

45) Who is the husband of B?

- a. A
- b. D
- c. C
- d. Cannot be determined
- e. None of these

46) If C is the son of B then how is B related to G?

- a. Son
- b. Daughter
- c. Aunt
- d. Niece
- e. None of these

47) How C related to G?

- a. Son
- b. Daughter
- c. Nephew
- d. Niece
- e. None of these

Direction (48-50): Read the information carefully and answer the following questions.

Ultra Practice Bundle PDF for All Bank Prelims Exams

There are eight members P, Q, R, S, T, U, V, W in a family. U is brother of T who is sister in law of R. S is grandson of P who is father of Q. V is only daughter of R who is wife of U. Q is the son of W who is mother of U. S is the only son of U.

48) How is W related to V?

- Mother
- Grandmother
- Sister
- Aunt
- None of these

49) How is Q related to V?

- Grandfather

- Father
- Uncle
- Aunt
- None of these

50) How is R related to P?

- Daughter in law
- Daughter
- Granddaughter
- Son
- None of these

Answers and Explanations

- c
- e
- b

Solution 1-3

From the given information,

- R is father-in-law of U, who is grandmother of V.
- P has two sons.
- T is father of S.
- P and U are married.
- The genders of S and Q is same. R is married.

Based on given data, we can draw family tree

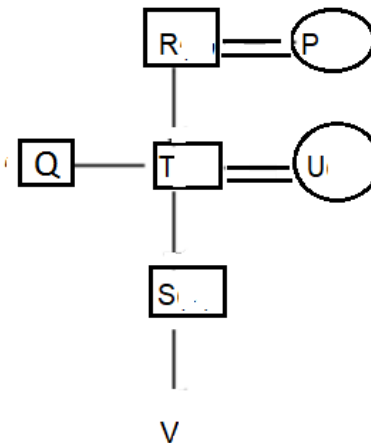

Answers

- b
- c
- c

Solution 4-6



Ultra Practice Bundle PDF for All Bank Prelims Exams

From the given information,

1. U is aunt of T. R is mother-in-law of S's husband.
2. Q has only one child.
3. S and Q are not married to each other.

Based on given data, we can draw family tree

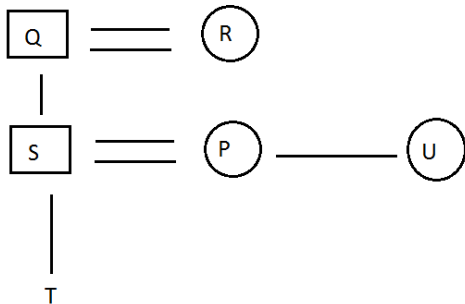

Answers

7. d
8. a
9. e

Solution 7-9

- 1) A is the father of D who is the brother of F (means D is the brother of F)
- 2) E is the husband of H.
- 3) F is the sister of E.
- 4) B is the son of D and husband of C.

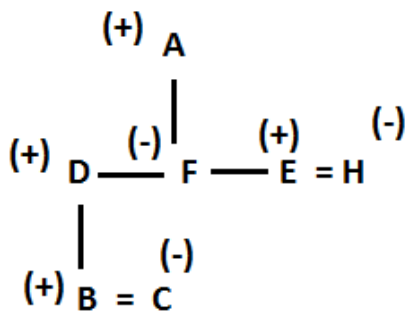

Answers

10. e
11. b
12. a

Solutions 10-12

- 1) B is the son of C but C is not the mother of B this implies that C is the Father of B.
- 2) A and C are married couples this implies that A is the mother of B.
- 3) D is daughter of A this implies that B and D are brother and sisters and both are children of A and C where A is the mother and C is the father.
- 4) E is brother of C, hence E is the brother in law of A and paternal uncle of B and D.
- 5) F is the brother of A, hence F is the brother in law of C and maternal uncle of B and D.

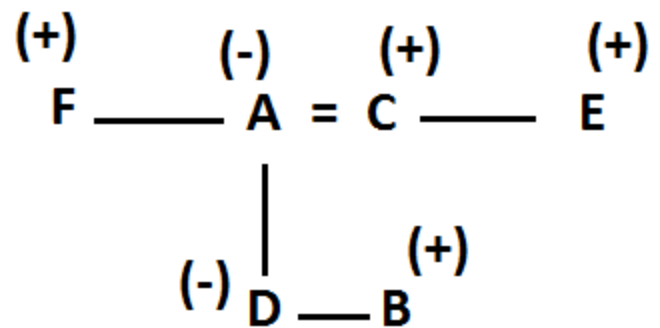

Answers

13. b
14. c
15. c

Solutions 13-15

From the given information,

1. R is father-in-law of T.



Ultra Practice Bundle PDF for All Bank Prelims Exams

2. S is son of Q, who is not married to R.

3. P's and Q's gender is same.

So, Q must be wife of T.

Based on given data, we can draw family tree

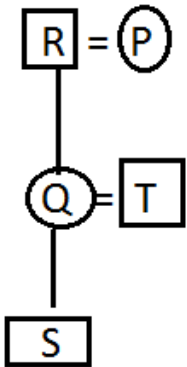

Answers

16. b

17. b

Solution 16-17

- 1) R is the daughter of Q and her son is T. T is not married
- 2) T's father is sitting next to P who is a male.
- 3) There are two couples present at the gathering.
- 4) R's parents are present in the gathering.

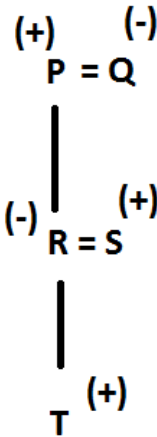

Answers

18. d

19. c

20. b

Solution 18-20

From the given information,

1. U is the only daughter of Q, who has three children.
2. W is the only sister in law of U.
3. P is the grandfather of S, whose father is V's brother, so V and R are the brother of U.
4. P is the father of V.

Based on given data, we can draw family tree

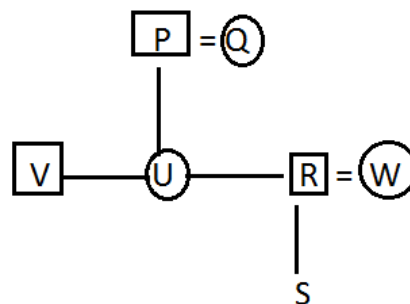

Answers

21. a

22. d



Ultra Practice Bundle PDF for All Bank Prelims Exams

23. a

Solution 21-23

There is couple in each generation. Q is daughter-in-law of P, who has two children. U is the son of R and does not have sibling. U is married to V. S is not married.

Family Tree:

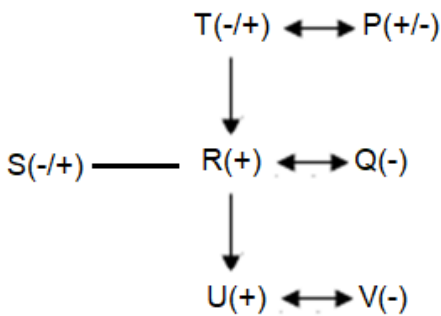

Answers:

24. d

25. a

26. a

Solutions 23-26

Now, there is equal number of males and females. No single parent has a child. F is father of A, who is married to D. B is grandmother of C. B has two children. E and D have same gender. So, we have,

Family Tree:

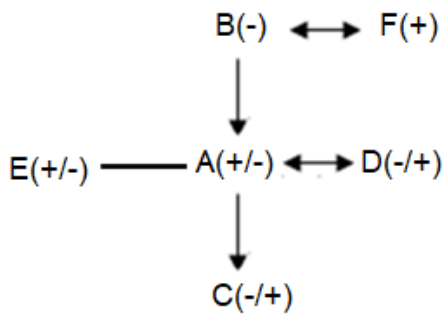

Answers:

27. e

28. c

29. c

30. a

Solutions 27-30

- 1) C and D are brothers while C is brother-in-law of E. (implying E is wife of D.)
- 2) B is mother-in-law of F. (implying B is female.)
- 3) G and H are sons of E and F respectively. (Implying G is son of E and D, F is mother or father of H.)
- 4) I and J are grand-children of A. (implying A is either grand-father or grand-mother of I and J.)
- 5) J is neither sister nor brother of H.
- 6) E has one daughter. (implying J is sister of G.)
- 7) There are three sets of couples living together with two children each. (Implying E and D, B and A, C and F are the three sets of couples.)

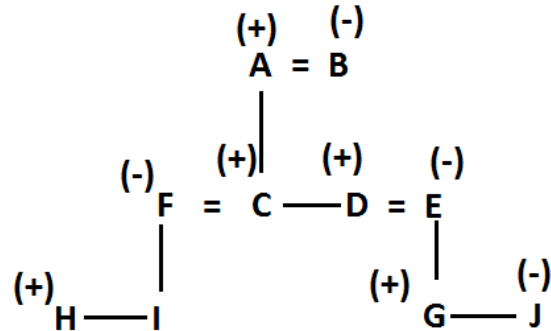

Answers

31. a

32. b

Solution 31-32



Ultra Practice Bundle PDF for All Bank Prelims Exams

- 1) A is married to B.
- 2) B has one son and one daughter.

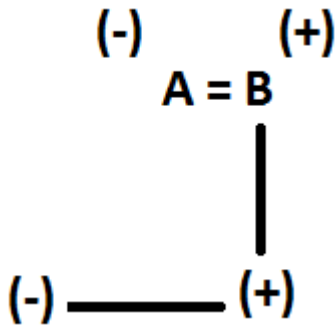

- 3) C who is the son of A is married to E.
- 4) E has one son.

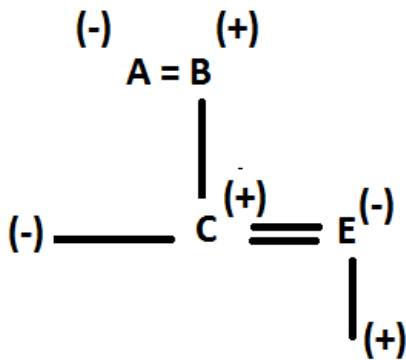

- 5) H is the son of D and nephew of C.
- 6) F is the wife of D
- 7) A is grandmother of G who is the cousin of H.

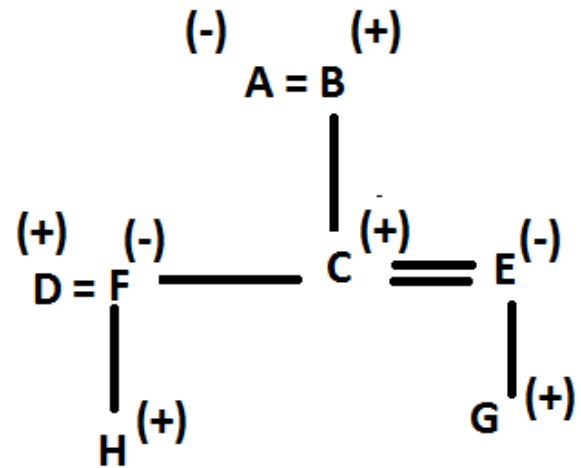

Answers

- 33. c
- 34. b
- 35. c

Solution 33-35

- 1) G, C's sister has two daughters.
- 2) H is maternal uncle of G's daughters.
- 3) B is son of C.
- 4) A is father of D, who is sister to B.

Thus the only members left are E and F. Thus, they are daughters of G.

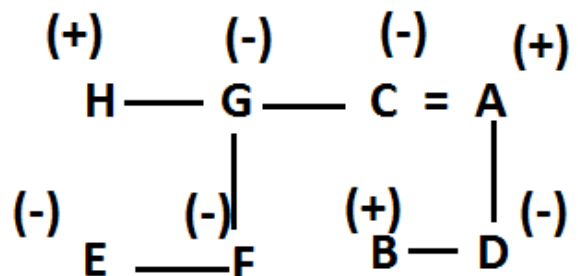

Answers:

- 36. d



Ultra Practice Bundle PDF for All Bank Prelims Exams

37. e

38. c

Solutions 36-38

1) B is the brother of H, who is the only daughter of A.

2) C is the son-in-law of D, who is the father of B.

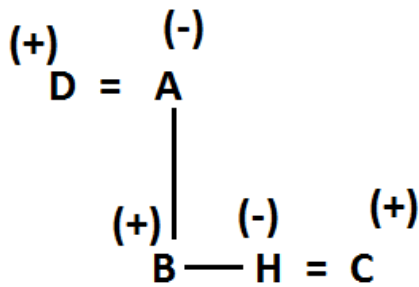

3) J is the only daughter of I, who is married to the only son of D.

4) G is the paternal Grandmother of E, who is the sister of F.

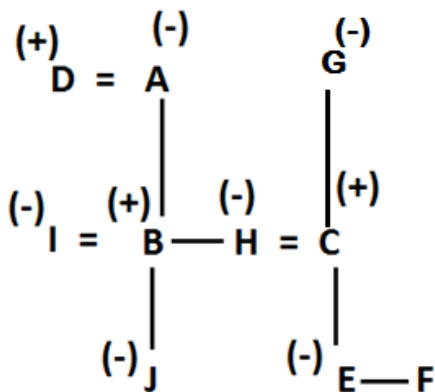

Answers:

39. b

40. a

41. b

Solutions 39-41

1. F's mother's only brother's father is B.

2. E is the only brother-in-law of H.

3. D's mother is the only daughter in law of B.

4. Number of males is more than the number of females.

5. G is the only daughter of A.

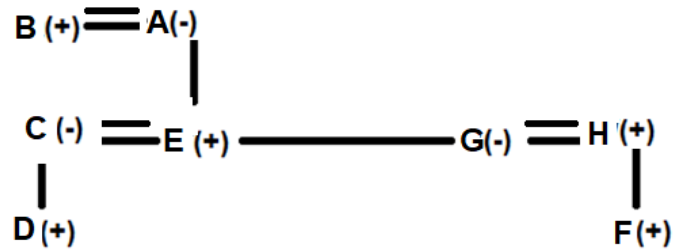

Answers

42. b

43. c

44. e

Solution 42-44

Sangeeta has two married sons and one married daughter

Ram is Mohan's son-in-law; Hence Mohan is married to Sangeeta and Ram is married to the only daughter of Sangeeta.

Geeta is Shyam's sister, Geeta has two brothers Shyam and Sohan.

Sita is not Sohan's wife, hence Sita is the wife of Shyam and Meeta is the wife of Sohan.

Ultra Practice Bundle PDF for All Bank Prelims Exams

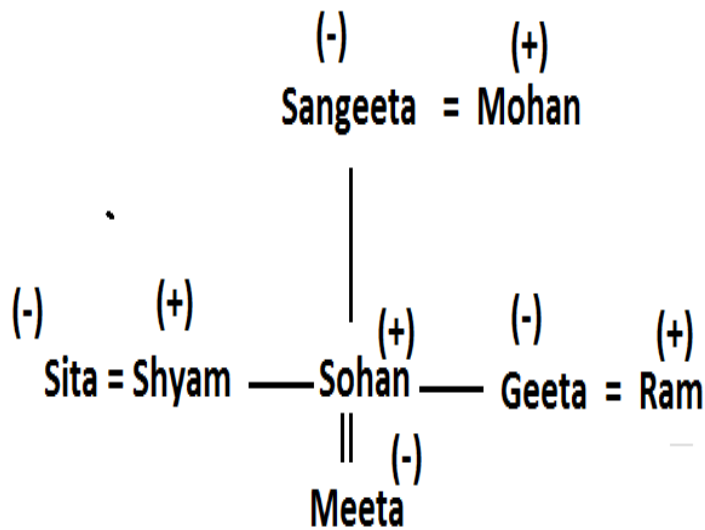

Answers:

45. d
46. c
47. c

Solutions 45-47

1. G's father's only sister's only daughter in law is F.
2. A is the only brother-in-law of D.
3. E is the only sister-in-law of B.
4. Either A or D is the husband of B.

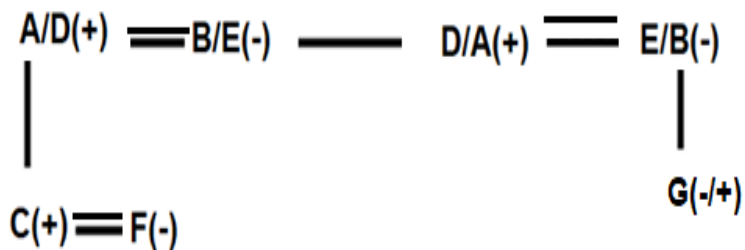
The final arrangement is as follows:

Answers

48. b
49. c
50. a

Solution 48-50

1. U is brother of T who is sister in law of R.
2. S is grandson of P who is father of Q.
3. V is only daughter of R who is wife of U.
4. Q is the son of W who is mother of U.
5. S is the only son of U.

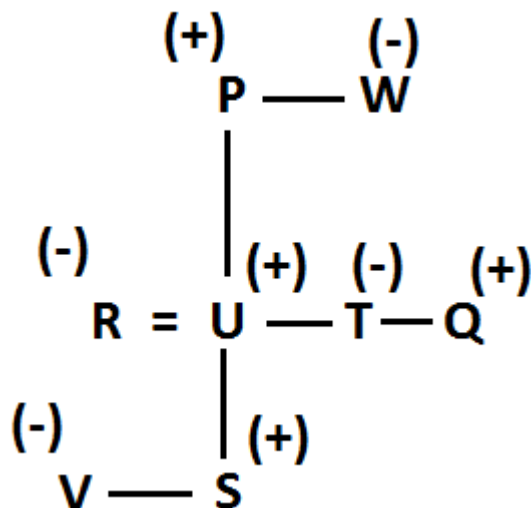

8. Number Sequence

Direction (1-5): The following questions are based on the five three-digit numbers given below.

234 756 867 123 815

Ultra Practice Bundle PDF for All Bank Prelims Exams

1) If 5 is subtracted from even numbers and 1 is added to odd numbers, then which of the following numbers is divisible by 3?

- a. 234
- b. 815
- c. 867
- d. 815
- e. 123

2) If the digits of the highest and the lowest numbers are reversed, which of the following is the new lowest number?

- a. 756
- b. 815
- c. 867
- d. 123
- e. 234

3) If the digits in each number are arranged in ascending order, how many numbers are odd?

- a. One
- b. Two
- c. Three
- d. More than three
- e. None

4) What will be the number obtained if the second digit of the smallest number is multiplied with the first digit of the largest number?

- a. 64
- b. 16
- c. 12

d. 74

e. 34

5) If the digits of each number are added together, then sum of the digits of which of the following number is perfect square?

- a. 815
- b. 123
- c. 234
- d. 756
- e. 867

Directions (6-10): Study the following arrangement of numbers and symbols carefully and answer the questions:

6 4 3 9 2 1 9 7 4 2 6 4 9 8 4 6 1 2 3 4 5 4 1

6) How many even numbers are immediately followed by a prime number?

- a. One
- b. Two
- c. Four
- d. Three
- e. None of these

7) If all the even numbers are dropped from the arrangement then which of the following will be 5th number to the right of the 4th number from the left end of the given arrangement?

- a. 9
- b. 5
- c. 1
- d. 3

Ultra Practice Bundle PDF for All Bank Prelims Exams

e. None of these

8) In the given arrangement, how many such numbers are there which are immediately preceded by an odd number?

- a. Seven
- b. Three
- c. Four
- d. Nine

e. None of these

9) What is the product of numbers between the first '9' from left end and fifth '4' from right end?

- a. 130
- b. 125
- c. 114
- d. 126

e. None of these

10) How many multiples of 3 are between first '2' from left and right end?

- a. Three
- b. Five
- c. Six
- d. Four

e. None of these

Directions (11-15): Study the following information carefully to answer the given questions:

245 854 457 652 129

11) If we interchange the 1st and 2nd digit of each number then which number will be the lowest among them?

a. 245

b. 854

c. 652

d. 129

e. 457

12) If we subtract 1 from the 3rd digit and then interchange with the 1st digit, then which number will be the greatest among them?

a. 129

b. 457

c. 245

d. 652

e. 854

13) If all the three digits of each number are arranged in ascending order and then all the numbers are arranged in decreasing order then find which element will be 3rd from left end?

a. 854

b. 245

c. 652

d. 129

e. 457

14) If all the three digits of each of the numbers are added the resulting sum of which of the following numbers will be a perfect square?

a. 245

b. 854

c. 652

d. 129

Ultra Practice Bundle PDF for All Bank Prelims Exams

e. 457

15) If in each number second and third digits are interchanged, then how many even numbers are there?

a. 4

b. 3

c. 2

d. 5

e. 1

Directions (16-20): Answer the questions based on the information given below.

4389 5124 7931 2478 6148

16) If in each of the given numbers, the second digit is interchanged with the fourth digit and the obtained value is divided by 3, which number is perfectly divided by 3 with the highest quotient?

a. 7931

b. 6148

c. 4389

d. 5124

e. 2478

17) If in each of the given numbers, the fourth digit of the number is subtracted from the first digit, which number will get the second highest value?

a. 6148

b. 5124

c. 4389

d. 7931

e. 2478

18) In each of the given numbers, the fourth digit is subtracted from the sum of the first three digits from left then which number will yield highest value?

a. 6148

b. 2478

c. 4389

d. 7931

e. 5124

19) If all the odd digits in the number are multiplied in each of the given numbers, which of the given numbers will yield a perfect cube?

a. 6148

b. 4389

c. 2478

d. 7931

e. Both (a) and (b)

20) If the difference between the highest and the lowest digit in each of the given numbers is considered then which of the following is the lowest value?

a. 7

b. 3

c. 4

d. 8

e. 6

Direction (21-25): Study the following number sequence and answer the questions following it.

9 8 6 1 5 7 9 8 3 2 7 9 8 6 2 7 6 1 5 4 3 2 5 2 1 7 9 8 6 1 4

Ultra Practice Bundle PDF for All Bank Prelims Exams

21) How many even numbers are there in the sequence each of which are immediately followed by an odd number?

- a. Seven
- b. Nine
- c. Six
- d. Eight
- e. None

22) How many 9s are followed by 8?

- a. Four
- b. Three
- c. Two
- d. One
- e. None

23) How many 8s are preceded by 9 and followed by 6?

- a. Two
- b. Three
- c. One
- d. More than Three
- e. None

24) In the following series of number, find out how many times 3 have appeared?

- a. Three
- b. Two
- c. Four
- d. Five
- e. Six

25) In the following series of number, find out how many times 1 followed by 5 have appeared together?

- a. Three
- b. One
- c. Four
- d. Two
- e. None

Directions (26-30): The following questions are based on the three digits five numbers given below.

545 644 784 527 898

26) If the 1st and 3rd digit of each of the number are multiplied then the resultant of which of the following numbers will be divisible by 5?

- a. 644
- b. 545 and 527
- c. 527 and 898
- d. 545
- e. 644 and 784

27) If 4 is added to the 1st digit of each number and then the positions of the 2nd and the 3rd digits are interchanged, which of the following will be the highest number?

- a. 545
- b. 527
- c. 898
- d. 784
- e. 644

28) If 2 is subtracted from the 2nd digit of each number and then the positions of the 1st and the 3rd

Ultra Practice Bundle PDF for All Bank Prelims Exams

digit are interchanged, which of the following will be the lowest number?

- a. 545
- b. 527
- c. 898
- d. 784
- e. 644

29) If in each number 1st and 3rd digits are interchanged, then how many even numbers are there?

- a. 1
- b. 2
- c. 3
- d. 4
- e. 5

30) What will be the number obtained if 2nd digit of the largest number is multiplied with 3rd digit of the smallest number?

- a. 64
- b. 57
- c. 63
- d. 54
- e. 44

Direction (31-35): Answer the questions based on the information given below.

These questions are based on the three digits five numbers.

176 489 721 562 723

31) If in each of the given numbers, third digit is interchanged by first digit then which number gives the highest quotient after being perfectly divisible by 3?

- a. 562
- b. 721
- c. 176
- d. 489
- e. 723

32) If in each of the given numbers, the third digit of the number is subtracted from the second digit, then which number will get the highest value?

- a. 721
- b. 489
- c. 176
- d. 562
- e. 723

33) In each of the given numbers, the second digit is subtracted from the sum of the first and last digits, which number will yield the second highest value?

- a. 489
- b. 721
- c. 562
- d. 723
- e. 176

34) If the digits of numbers are added and 5 is subtracted, then which number gives the highest number?

- a. 721
- b. 562

Ultra Practice Bundle PDF for All Bank Prelims Exams

c. 723

d. 489

e. 176

35) If in each number first and third digits are interchanged, then how many odd numbers are there?

a. 4

b. 3

c. 2

d. 5

e. 1

Direction (36-40): The following questions are based on the five three-digit numbers given below.

234 435 716 901 625

36) If all the numbers are arranged in ascending order, what will be the result of the product (multiplication) of the first digit of the third number and the third digit of the first number from the left end of the new arrangement?

a. 35

b. 58

c. 87

d. 24

e. 8

37) What will be the number obtained if the highest number in the series is added with the second-lowest number in the series?

a. 1735

b. 643

c. 1336

d. 638

e. 1073

38) If the highest and the lowest numbers are added, what will be the product of the first and third digit of the resulting sum?

a. 8

b. 5

c. 3

d. 1

e. 4

39) If 1 is subtracted from the odd digits in each number, which of the following is the new highest number?

a. 234

b. 435

c. 716

d. 901

e. 625

40) If all the digits in each number are arranged in descending order, which of the following number will remain unchanged?

a. 234

b. 716

c. 625

d. 901

e. none

Directions (41-45): Following questions are based on the given sequence of numbers:

Ultra Practice Bundle PDF for All Bank Prelims Exams

9 3 9 5 9 3 6 9 6 4 3 5 3 5 8 3 8 3 9 3 9 3 9 5 3 9 5 9 4 6 6
4 6 9 6

41) How many 3s are there which are preceded by 9 and immediately followed by 9 in the above set of numbers?

- a. 1
- b. 4
- c. 5
- d. 2
- e. 3

42) Which digit has least frequency in the above set of figures?

- a. 5
- b. 9
- c. 8
- d. 6
- e. 3

43) If the number of elements in the series is divided from the frequency of 3 in the series, what is the remainder?

- a. 4
- b. 7
- c. 5
- d. 8
- e. None

44) Which digit has the lowest frequency leaving digit 4 and 8 in the above set of numbers.

- a. 6
- b. 9

c. 5

d. Cannot be determined

e. None of these

45) There are pairs of adjoining figures which add up to 13. How many such pairs are there?

- a. 1
- b. 2
- c. 3
- d. 6

e. None

Directions (46-50): The following questions are based on the five four-digit numbers given below:

5689 1676 3648 2941 5937

46) If all the digits of each of the numbers are added the resulting sum of which of the following numbers is an odd number?

- a. 5689
- b. 1676
- c. 3648
- d. 2941
- e. 5937

47) If each of the numbers given in the series are reversed then which of the following numbers is second highest number?

- a. 5689
- b. 1676
- c. 3648
- d. 2941
- e. 5937

Ultra Practice Bundle PDF for All Bank Prelims Exams

48) If first and third digits of each number are removed then what is the sum of the second highest and second lowest numbers of the resultant series?

- a. 158
- b. 159
- c. 160
- d. 161
- e. 162

49) If second and third digits are interchanged within the numbers then what is the difference between the highest and lowest number of the resultant series?

- a. 4103
- b. 4003

c. 5103

d. 5003

e. 4113

50) What will be the number obtained if the lowest number in the series is added with the second-highest number in the series?

a. 7365

b. 6430

c. 1336

d. 6380

e. 1073

Solution with Explanation

Answers:

- 1. b
- 2. e
- 3. b
- 4. b
- 5. c

Solution 1

Given series: 234 756 867 123 815

1) On subtracting 5 from even numbers and adding 1 to the odd numbers:

229 751 868 124 816

Old number	New number
234	229
756	751
867	868

123	124
815	816

Solution 2

Given series: 234 756 867 123 815

Highest number: 867

Lowest number: 123

On reversing highest and lowest number, the new arrangement: 234 756 768 321 815

Hence, the new lowest number is 234.

Solution 3

Given series: 234 756 867 123 815

After the digits of each number arranged in ascending order:

Old number	New number
234	234
756	567
867	678
123	123
815	158

Ultra Practice Bundle PDF for All Bank Prelims Exams

234	234
756	567
867	678
123	123
815	158

New series will be: 234 567 678 123 158

567 and 123 are the odd numbers.

Hence, there are two odd numbers.

Solution 4

Given series: 234 756 867 123 815

Smallest number = 123

Second digit of 123 (smallest number) = 2

Largest number = 867

First digit of 867 (highest number) = 8

On multiplying them we get, $2 \times 8 = 16$

Hence, the number obtained is 16.

Solution 5

Given series: 234 756 867 123 815

On adding digits of a number:

$$234 \rightarrow 2 + 3 + 4 = 9$$

$$756 \rightarrow 7 + 5 + 6 = 18$$

$$867 \rightarrow 8 + 6 + 7 = 21$$

$$123 \rightarrow 1 + 2 + 3 = 6$$

$$815 \rightarrow 8 + 1 + 5 = 14$$

Here, 9 is a perfect square.

Hence, the required number is 234.

Answers:

6. c

7. b

8. d

9. d

10. d

Solution 6

Given series,

6 4 3 9 2 1 9 7 4 2 6 4 9 8 4 6 1 2 3 4 5 4 1

Four even numbers are immediately followed by a prime number.

Hence, option c is correct.

Solution 7

Given series,

6 4 3 9 2 1 9 7 4 2 6 4 9 8 4 6 1 2 3 4 5 4 1

If we dropped even numbers,

3 9 1 9 7 9 1 3 5 1

So, the 5th number to the right of the 4th number from the left end of the given arrangement is '5'.

Hence, option b is correct.

Solution 8

Given series,

6 4 3 9 2 1 9 7 4 2 6 4 9 8 4 6 1 2 3 4 5 4 1

So, there are nine numbers, which are immediately preceded by an odd number.

Hence, option d is correct.

Solution 9

Given series,

6 4 3 9 2 1 9 7 4 2 6 4 9 8 4 6 1 2 3 4 5 4 1

$$\text{Product} = 2 \times 1 \times 9 \times 7 = 126$$

Hence, option d is correct.

Solution 10

Given series,

Ultra Practice Bundle PDF for All Bank Prelims Exams

6 4 3 9 2 1 9 7 4 2 6 4 9 8 4 6 1 2 3 4 5 4 1

There are four multiples of '3' between first '2' from left and right end.

Hence, option d is correct.

Answers:

11. d

12. a

13. c

14. e

15. c

Solution 11

Given series:- 245 854 457 652 129

Interchanging 1st and 2nd digit of each number,

425 584 547 562 219

So from the above series 219 is the lowest term among them.

Hence, "129" is the correct answer.

Solution 12

Given series:- 245 854 457 652 129

Subtracting 1 from 3rd digit,

244 853 456 651 128

Interchanging it with 1st digit,

442 358 654 165 821

So from the above series 821 is the greatest one among them.

Hence, "129" is the correct answer.

Solution 13

Given series :- 245 854 457 652 129

Arranging each number in ascending order,

245 458 457 256 129

Arranging numbers in decreasing order,

458 457 256 245 129

So, from the above series we can say that "256" comes 3rd from left end.

Hence, "652" is the correct answer.

Solution 14

Given series: 245 854 457 652 129

On adding the digits,

245 → 2 + 4 + 5 = 11

854 → 8 + 5 + 4 = 17

652 → 6 + 5 + 2 = 11

129 → 1 + 2 + 9 = 12

457 → 4 + 5 + 7 = 16

Hence, "457" is the number whose sum is a perfect square.

Solution 15

Given series:- 245 854 457 652 129

Interchanging second and third number,

254 845 475 625 192

Hence, there are two such numbers which are even numbers.

Answers:

16. d

17. b

18. d

19. e

20. c

Solution 16

Given numbers:

4389 5124 7931 2478 6148

The second digit interchanged with the fourth digit, we get

Ultra Practice Bundle PDF for All Bank Prelims Exams

4983 5421 7139 2874 6841

On dividing these values, the numbers perfectly divisible by 3 with the highest quotient,

4983 – Divisible with quotient 1661

5421 – Divisible with quotient 1807

7139 – Not divisible

2874 – Divisible with quotient 958

6841 – Not divisible

So, 1807 is the highest quotient which represents 5124.

Solution 17

Given numbers:

4389 5124 7931 2478 6148

The fourth digit of the numbers is subtracted from the first digit, we get

-5 1 6 -6 -2

The second highest number is 1.

Solution 18

Given numbers:

4389 5124 7931 2478 6148

The fourth digit is subtracted from the sum of the first three digits, we get

6 4 18 5 3

So, the highest value; 18, which is represented by 7931.

Solution 19

Given numbers:

4389 5124 7931 2478 6148

If all the odd digits in the number are multiplied for each of the given numbers, we get-

27 5 189 7 1

Perfect cube: 27 and 1

Solution 20

Given numbers:

4389 5124 7931 2478 6148

Difference between the highest and the lowest digit in each of the given numbers,

6 4 8 6 7

Lowest value: 4

Answers:

21. b

22. a

23. b

24. b

25. d

Solution 21

Given Series: 9 8 6 1 5 7 9 8 3 2 7 9 8 6 2 7 6 1 5 4 3 2 5
2 1 7 9 8 6 1 4

Clearly, an even number followed by an odd number in the sequence are:

9 8 6 1 5 7 9 8 3 2 7 9 8 6 2 7 6 1 5 4 3 2 5 2 1 7 9 8 6 1 4

Thus, the correct answer is Nine.

Solution 22

Given Series: 9 8 6 1 5 7 9 8 3 2 7 9 8 6 2 7 6 1 5 4 3 2 5
2 1 7 9 8 6 1 4

Clearly, there are four 9s followed by 8.

9 8 6 1 5 7 9 8 3 2 7 9 8 6 2 7 6 1 5 4 3 2 5 2 1 7 9 8 6 1 4

Thus, the correct answer is four.

Solution 23

Given Series: 9 8 6 1 5 7 9 8 3 2 7 9 8 6 2 7 6 1 5 4 3 2 5
2 1 7 9 8 6 1 4

Clearly, there are three 8s preceded by 9 and followed by 6.

9 8 6 1 5 7 9 8 3 2 7 9 8 6 2 7 6 1 5 4 3 2 5 2 1 7 9 8 6 1 4

Ultra Practice Bundle PDF for All Bank Prelims Exams

Thus, the correct answer is three.

Solution 24

Given Series: 9 8 6 1 5 7 9 8 3 2 7 9 8 6 2 7 6 1 5 4 3 2 5
2 1 7 9 8 6 1 4

Clearly, 3 appears two times in the given number series.

9 8 6 1 5 7 9 8 3 2 7 9 8 6 2 7 6 1 5 4 3 2 5 2 1 7 9 8 6 1 4

Thus, the correct answer is two.

Solution 25

Given Series: 9 8 6 1 5 7 9 8 3 2 7 9 8 6 2 7 6 1 5 4 3 2 5
2 1 7 9 8 6 1 4

Clearly, 1 and 5 have appeared two times together in the given number series.

9 8 6 15 7 9 8 3 2 7 9 8 6 2 7 6 15 4 3 2 5 2 1 7 9 8 6 1 4

Thus, the correct answer is two.

Answers:

26. b

27. c

28. e

29. b

30. c

Solution 26

Given series: 545 644 784 527 898

on multiplying 1st and last digits:

545: $5 \times 5 = 25$

644: $6 \times 4 = 24$

784: $7 \times 4 = 28$

527: $5 \times 7 = 35$

898: $8 \times 8 = 64$

Here 35 and 25 are only divisible by 5.

Hence answer is 527 and 545.

Solution 27

Given series: 545 644 784 527 898

Adding 4 to the 1st digit: 945 1044 1184 927 1298

interchanging the 2nd and the 3rd digit: 954 1404 1814
972 1928

So, 1928 is highest number which came from 898.

Solution 28

Given series: 545 644 784 527 898

Subtracting 2 from the 2nd digit: 525 624 764 507 878

interchanging the 1st and the 3rd digit: 525 426 467 705
878

So 426 is the lowest number, which came from 644.

Solution 29

Given series: 545 644 784 527 898

Interchanging the 1st and 3rd digits: 545 446 487 725 898

hence 2 even number, which came from 644, 898

Solution 30

Given series: 545 644 784 527 898

Largest no is in the series: 898

Smallest no is in the series: 527

2nd digit of largest no: 9

3rd digit of smallest no: 7

After multiplying this: $9 \times 7 = 63$

Answers:

31. d

32. d

33. b

34. d

35. a

Solution 31

Given numbers: 176 489 721 562 723

Ultra Practice Bundle PDF for All Bank Prelims Exams

The third digit interchanged with the first digit, we get

671 984 127 265 327

On dividing these values, the numbers perfectly divisible by 3 with the highest quotient,

671 – Not divisible

984 – 328

127– Not divisible

265 – Not divisible

327 – 109

So, 328 is the highest quotient which represents 489.

Solution 32

Given numbers:

176 489 721 562 723

The third digit of the numbers is subtracted from the 2nd digit, we get

1 -1 1 4 -1

The highest number is 4, which is represented by 562.

Solution 33

Given numbers:

176 489 721 562 723

The 2nd digit is subtracted from the sum of the first three digits, we get

0 5 6 1 8

So, the second highest value is 6, which is represented by 721.

Solution 34

Given numbers:

176 489 721 562 723

If all the number are added and 5 is subtracted, we get,

9 16 5 8 7

Highest number: 16

Solution 35

Given series: 176 489 721 562 723

After interchanging First and Third digit

617 984 127 265 327

Hence, there are four odd numbers.

Answers:

36. d

37. c

38. c

39. d

40. e

Solution 36

Given series: 234 435 716 901 625

After rearranging the numbers in ascending order:

234 435 625 716 901

The first digit of the third number (625) = 6

The third digit of the first number (234) = 4

On multiplying the first digit of the third number and the third digit of the first number, we get:

$$6 \times 4 = 24$$

Hence, the resultant product is 24.

Solution 37

Given series: 234 435 716 901 625

The highest number in the series = 901

The second-lowest number in the series = 435

On addition of the highest number and second-lowest number in a series, we get:

$$901 + 435 = 1336$$

Hence, the sum will be 1336.

Ultra Practice Bundle PDF for All Bank Prelims Exams

Solution 38

Given series: 234 435 716 901 625

Highest number = 901

Lowest number = 234

The sum of the highest and the lowest number = $901 + 234 = 1135$;

The product of the first and third digit of the sum (1135) = $1 \times 3 = 3$

Hence, the product will be 3.

Solution 39

Given series: 234 435 716 901 625

Number	Odd digits
234	3
435	3 and 5
716	7 and 1
901	9 and 1
625	2 and 5

On subtracting 1 from odd digits:

224 424 606 800 624

Hence, the new highest number is 800.

Solution 40

Given series: 234 435 716 901 625

On rearranging digits in a number in descending order,

Old number	New number
234	432
435	543
716	761
901	910
625	652

Thus, we get the following arrangement:

432 543 761 910 652

Here, none of the numbers remain unchanged.

Hence, the answer is 'none'.

Answers:

41. e

42. c

43. d

44. c

45. b

Solution 41

Given series: 9 3 9 5 9 3 6 9 6 4 3 5 3 5 8 3 8 3 9 3 9 3 9
5 3 9 5 9 4 6 6 4 6 9 6

3s are there which are preceded by 9 and immediately followed by 9

Pattern required: $9 \rightarrow 3 \rightarrow 9$

9 3 9 5 9 3 6 9 6 4 3 5 3 5 8 3 8 3 9 3 9 3 9 5 3 9 5 9 4 6 6
4 6 9 6

Clearly, three such 3s are there.

Solution 42

Given series: 9 3 9 5 9 3 6 9 6 4 3 5 3 5 8 3 8 3 9 3 9 3 9
5 3 9 5 9 4 6 6 4 6 9 6

Let's check,

We have,

8's = 2

9's = 10

6's = 6

3's = 9

5's = 5

4's = 3

So, 8's has least frequency in the above set of figures.

Ultra Practice Bundle PDF for All Bank Prelims Exams

Solution 43

Given series: 9 3 9 5 9 3 6 9 6 4 3 5 3 5 8 3 8 3 9 3 9 3 9
5 3 9 5 9 4 6 6 4 6 9 6

Number of elements in the series = 35 ... (1)

Let's check,

3's = 9 ... (2)

When 35 is divided by 9 the remainder will be 8.

Thus, 8 is the answer.

Solution 44

Given series: 9 3 9 5 9 3 6 9 6 4 3 5 3 5 8 3 8 3 9 3 9 3 9
5 3 9 5 9 4 6 6 4 6 9 6

Let's check,

We have,

9's = 10

6's = 6

3's = 9

5's = 5

Thus, digit 5 has lowest frequency leaving digit 4 and 8.

Solution 45

Given series: 9 3 9 5 9 3 6 9 6 4 3 5 3 **5 8** 3 8 3 9 3 9 3 9
5 3 9 5 **9 4** 6 6 4 6 9 6

Clearly there is two such pair of adjoining figures which add up to 13.

Answers:

46. c

47. c

48. b

49. a

50. a

Solution 46

Given numbers: 5689 1676 3648 2941 5937

On adding all the digits

5689 → 28

1676 → 20

3648 → 21

2941 → 16

5937 → 24

Here, all numbers are even except 21.

Hence, odd number is 3648.

Solution 47

Given numbers: 5689 1676 3648 2941 5937

On reversing the numbers

5689 → 9865

1676 → 6761

3648 → 8463

2941 → 1492

5937 → 7395

Hence, the second highest number is 3648

Solution 48

Given numbers: 5689 1676 3648 2941 5937

Removing first and third digits:

5689 → 69

1676 → 66

3648 → 68

2941 → 91

5937 → 97

Arranging the numbers in descending order:

97, 91, 69, 68, 66

Sum of second highest and second lowest numbers: $91 + 68 = 159$

Hence, answer is 159.

Solution 49

Given numbers: 5689 1676 3648 2941 5937

Ultra Practice Bundle PDF for All Bank Prelims Exams

Interchanging the second and third digits within the numbers:

5689 → 5869

1676 → 1766

3648 → 3468

2941 → 2491

5937 → 5397

The highest and lowest numbers are 5869 and 1766 respectively

The difference is $5869 - 1766 = 4103$

Hence, answer is 4103.

Solution 50

Given numbers: 5689 1676 3648 2941 5937

Adding the lowest number and second highest number

$5689 + 1676 = 7365$

Hence, 7365 is the correct answer.

9. Alphabet Series

Direction (1-5): Following questions are based on five words given below.

DEW BIG RAW FAN DOG

(The new words formed after performing the mentioned operations may or may not necessarily be meaningful English words)

1) If alphabets of the given words are arranged according to dictionary order and then words are arranged in the order as they would appear in a dictionary from left to right, which of the following word will be at last position?

- a. RAW
- b. FAN
- c. DOG
- d. DEW
- e. BIG

2) If the positions of first and last alphabets of each word are interchanged, how many meaningful words are formed?

- a. Two
- b. Three
- c. One
- d. Four
- e. None of these

3) If the positions of first and last alphabets of each word are interchanged and arranged from dictionary order then, which word comes last?

- a. DEW
- b. FAN
- c. DOG
- d. RAW
- e. BIG

4) If the first alphabets of each word are exchanged by its next alphabet according to English alphabetical series, how many meaningful words are formed?

- a. Two

Ultra Practice Bundle PDF for All Bank Prelims Exams

- b. Three
- c. One
- d. Four
- e. None of these

5) If the positions of first and second alphabets of each word are interchanged, which comes third in the order of dictionary?

- a. FAN
- b. DEW
- c. DOG
- d. RAW
- e. BIG

Directions (6-10): The following questions are based on the five three-letter words given below.

WOF KEH PIL TAX JUV

6) If words are arranged according to the alphabetical series from left to right, which word is fourth from the right end?

- a. JUV
- b. KEH
- c. PIL
- d. WOF
- e. TAX

7) If in each word, the vowel is replaced by its preceding letter in English alphabetical series and the consonant is replaced by its succeeding letter in English alphabetical series, which word thus formed would come second from the left end?

- a. QHM
- b. UZY
- c. LDI

- d. XNG
- e. KTW

8) If the third letter of all the words is changed to its next letter (succeeding) of the English alphabetical series, then how many words will have more than one vowel? (Same or different vowel)

- a. Three
- b. Two
- c. More than three
- d. None
- e. One

9) If the positions of the first and second letters of all the words are interchanged, how many words will form meaningful English words?

- a. Zero
- b. Four
- c. Two
- d. One
- e. Three

10) If the positions of first and third alphabets of each word are interchanged, which comes second from the right?

- a. FOW
- b. HEK
- c. LIP
- d. XAT
- e. VUJ

Directions (11-15): Study the following arrangement of numbers carefully and answer the questions.

6 8 3 9 3 8 6 8 2 6 2 7 5 4 3 5 4 7 4 6 9 2 6 2 5

11) How many even numbers are there which are immediately followed by an odd number and immediately preceded by a prime number?

Ultra Practice Bundle PDF for All Bank Prelims Exams

- a. Two
- b. Four
- c. One
- d. Three
- e. None of these

12) What is the sum of all the numbers between 2nd '6' from the left end and 3rd '5' from the right end in the given series?

- a. 24
- b. 27
- c. 25
- d. 22
- e. None of these

13) How many prime numbers are to the left of 14th number from the right end in the given series?

- a. Three
- b. Four
- c. Two
- d. Five
- e. None of these

14) How many odd numbers are there which are immediately followed and immediately preceded by an even number in the given series?

- a. Two
- b. One
- c. Four
- d. Three
- e. None of these

15) Which number is in the middle of the numbers, which are 7th from the left end and 11th from the right end in the given series?

- a. 8
- b. 6
- c. 7
- d. 2
- e. None of these

Directions (16-20): Study the given arrangement of alphabets and answer the questions based on it.

W T Y C O K P Q Z B M N A E R I K L G D H F U J X
V R Q T V

16) How many consonants are there in the above arrangement which are immediately followed by a vowel and preceded by a consonant?

- a. Two
- b. Three
- c. Four
- d. Five
- e. None of these

17) Which of the following alphabet is 9th to the right of 4th letter from the left end?

- a. W
- b. V
- c. T
- d. A
- e. None of these

18) How many letters are there in between the alphabet which is 8th from the left end and the alphabet which 9th from the right end?

Ultra Practice Bundle PDF for All Bank Prelims Exams

- a. 13
- b. 12
- c. 10
- d. 17
- e. 14

19) Complete the given series based on the arrangement given.

CKQ, BNE, ILD, ?

- a. FUJ
- b. QVT
- c. FJV
- d. XVR
- e. None of these

20) If all the vowels from the above arrangement are dropped then which of the following letter is 13th from the left end?

- a. L
- b. R
- c. K
- d. Z
- e. None of these

Direction (21-25): The following questions are based on the five words given below. (The new words formed after performing the mentioned operations may or may not necessarily be meaningful English words)

KEDU EDRT FHRA ULTP HKED

21) If the last alphabet in each of the words is changed to the next alphabet in the English

alphabetical series, then how many words having two identical vowels will be formed?

- a. Three
- b. Zero
- c. Two
- d. One
- e. Four

22) If the first alphabet in each of the words is changed to the next alphabet in the English alphabetical series, then how many words having two different vowels will be formed?

- a. Three
- b. Four
- c. One
- d. Two
- e. Five

23) How many meaningful words can be made using all the letters of the word KEDU only once?

- a. One
- b. Four
- c. Three
- d. Two
- e. Five

24) How many alphabets (as per English alphabetical order) would lie between the second letter of the third word from the left and the second letter of the second word from the right?

- a. Five
- b. Six

Ultra Practice Bundle PDF for All Bank Prelims Exams

- c. Three
- d. Two
- e. Four

25) Which word will be the second last word if the words are arranged according to their place in the dictionary taking into consideration the last letter of each word?

- a. KEDU
- b. EDRT
- c. FHRA
- d. ULTP
- e. HKED

Directions (26-30): The following questions are based on the six words given below.

MFE HTY ELG PSY NOE LZB

26) If first two alphabets of each word are interchanged, then how many meaningful words are formed?

- a. One
- b. Two
- c. Three
- d. Four
- e. Five

27) If the first alphabet of each word is interchanged with the third alphabet of it, then which word will be the second if they are arranged in the order as they would appear in dictionary?

- a. MFE
- b. HTY
- c. ELG

- d. PSY
- e. NOE

28) If in each of the given words, each of the consonants is changed to previous letter and each vowel is changed to next letter in the English alphabetical series, in how many words thus formed will no vowels appear?

- a. None
- b. One
- c. Two
- d. Three
- e. Five

29) How many letters are there in the English alphabetical order between third letter of the word which is fourth from the right and the second letter of the word which is fourth from the left of the given words?

- a. Ten
- b. Two
- c. Eleven
- d. Thirteen
- e. Three

30) If last two alphabets of each word are interchanged, then how many meaningful words are formed?

- a. One
- b. Two
- c. Three
- d. Four
- e. Five

Ultra Practice Bundle PDF for All Bank Prelims Exams

Direction (31-35): Following questions are based on five words given below.

(The new words formed after performing the mentioned operations may or may not necessarily be meaningful English words)

TOB UDC RES PFB YWQ

31) If we interchange both alphabets of each word present at odd positions, how many words ending with vowels will be formed?

- a. Four
- b. Three
- c. One
- d. Two
- e. None of These

32) If the first and last alphabet of each word is changed to the previous alphabet and the middle alphabet is changed to its next alphabet in the English alphabetical order, how many words having only consonants will be formed?

- a. One
- b. Three
- c. Four
- d. Two
- e. Five

33) If the given words are arranged in the order as they would appear in a dictionary from left to right, how many alphabets are there in English alphabetical series between first and last letter of the word which will be at fourth from right?

- a. One
- b. Two

- c. Three
- d. Four
- e. None

34) If in each of the words, all the alphabets are arranged in English alphabetical order within the word, how many words will end with a consonant?

- a. Three
- b. Four
- c. One
- d. Two
- e. None

35) How many letters are there in the English alphabetical series between the first letter of the word which is second from the left and the second letter of the word which is first from the right of the given words?

- a. One
- b. Two
- c. Three
- d. Four
- e. None

Direction (36-40): Study the following alphabet series and answer the question that follows.

T H A T I S A W O N D E R F U L S C E N E R Y

36) If each consonant is substituted with the letter preceding it in the English alphabetical series and each vowel is substituted with the next letter of the alphabetical series. How many vowels are present in the new arrangement?

- a. 1

Ultra Practice Bundle PDF for All Bank Prelims Exams

b. 2

c. 3

d. 5

e. 4

37) If seven letters from the right end are placed between the fourth and the fifth letter from the left end then which is the 8th letter from the left end in the new arrangement?

a. I

b. S

c. N

d. C

e. E

38) Which letter is placed at the immediate left of the 23rd letter of the English alphabet in the arrangement?

a. W

b. O

c. N

d. D

e. A

39) Four of the following five are alike in a certain way based on their positions in the above arrangement and hence form a group. Which one among the following does not belong to that group?

a. STW

b. OAD

c. URS

d. EEY

e. IAO

40) Which of the following alphabet is 9th to the right of 4th letter from the left end?

a. N

b. D

c. E

d. R

e. None of these

Directions (41-45): Study the following arrangement of the English alphabet and answer the questions given below:

V G C L X Q D U I T H S F P Z J R N O W Y M B E K
A

41) Four of the following five are alike in a certain way based on their position in the above arrangement and hence form a group. Which one does not belong to that group?

a. BKY

b. VCX

c. DIX

d. SPT

e. NWJ

42) Which of the following letter will be at the immediate right of the 2nd vowel of the English alphabetical series?

a. B

b. D

c. K

d. I

e. W



Ultra Practice Bundle PDF for All Bank Prelims Exams

43) If first six letters from the left end are placed between the seventh and the eighth letters from the right end, what will be the fifth letter to the right of the twelfth letter from the left?

- a. H
- b. L
- c. S
- d. O
- e. D

44) Which is the 8th letter from the left of the letter which is 3rd from the right?

- a. Z
- b. J
- c. N
- d. R
- e. O

45) Which letter is placed at the immediate left of the 7th letter of the English alphabet in the arrangement?

- a. W
- b. O
- c. V
- d. D
- e. A

Directions (46-50): Study the following alphabet series and answer the questions that follow:

A C E U H D S V Z P O J G R Y N L K B W T

46) In the given series, how many vowels are immediately followed by another vowel?

- a. One

- b. Two
- c. Three
- d. None
- e. More than three

47) Which of the following letters will be third to the left of the first vowel from the right end?

- a. G
- b. E
- c. V
- d. L
- e. H

48) If all the letters from the given series are arranged in alphabetical order from the left, then how many letters will not change its position?

- a. five
- b. two
- c. three
- d. one
- e. four

49) How many letters are there in the English alphabetical series between the sixth letter from the right end and the seventh letter from the left end?

- a. Two
- b. Five
- c. Seven
- d. Eight
- e. Four

50) Four of the following five are alike in a certain way based on their positions in the above

Ultra Practice Bundle PDF for All Bank Prelims Exams

arrangement and hence form a group. Which one does not belong to that group?

- a. CEH
- b. VZJ

- c. DSZ
- d. RYL
- e. JGY

Solution with Explanation

Answers:

- 1. c
- 2. d
- 3. a
- 4. c
- 5. b

Solution 1

Given words are: DEW BIG RAW FAN DOG

On arranging alphabets according to the dictionary:

DEW BGI ARW AFN DGO

Now on arranging words in the order as they appear in a dictionary from left to right, we get:

Left side: AFN ARW BGI DEW DGO : Right side

Thus, DOG is the last word.

Solution 2

Given words are: DEW BIG RAW FAN DOG

On exchanging the alphabets:

WED GIB WAR NAF GOD

The meaningful words are: WED, GIB, WAR, and GOD

Thus, the correct answer is 'Four'.

Solution 3

Given words are: DEW BIG RAW FAN DOG

On exchanging the alphabets:

WED GIB WAR NAF GOD

When arranged in dictionary order: GIB, GOD, NAF, WAR, WED

WED is the last word after arranged in dictionary order.

Thus, the correct answer is 'DEW'.

Solution 4

Given words are: DEW BIG RAW FAN DOG

On exchanging the alphabets:

EEW CIG SAW GAN EOG

The meaningful words are: SAW

Thus, the correct answer is 'RAW'.

Solution 5

Given words are: DEW BIG RAW FAN DOG

On exchanging the alphabets:

EDW IBG ARW AFN ODG

Dictionary order: AFN, ARW, EDW, IBG, ODG

Third word from dictionary order is: EDW

Thus, the correct answer is 'DEW'.

Answers:

- 6. b
- 7. c
- 8. e
- 9. a
- 10. d

Solution 6

Given series- WOF KEH PIL TAX JUV

Words are arranged according to the alphabetical series from left to right:

JUV KEH PIL TAX WOF

So, KEH is fourth from the right end.

Solution 7

Ultra Practice Bundle PDF for All Bank Prelims Exams

Given series- WOF KEH PIL TAX JUV

After replacing the vowels with their preceding letters and constants with their succeeding letters in English alphabetical series, the resulting series formed would be:

XNG LDI QHM UZY KTW

So, the word that is second from the left end: LDI

Hence, the answer is LDI.

Solution 8

Hence, the answer is KEH.

Given series- WOF KEH PIL TAX JUV

The third letter of all the words is changed to its next letter (succeeding) of the English alphabetical series:

WOG KEI PIM TAY JUW

So, one word (KEI) will have more than one vowel.

Hence, the answer is one.

Solution 9

Given series- WOF KEH PIL TAX JUV

Positions of the first and second letters of all the words are interchanged:

OWF EKH IPL ATX UJV

So, no word will form meaningful English words.

Hence, the answer is zero.

Solution 10

Given series- WOF KEH PIL TAX JUV

Positions of the first and third letters of all the words are interchanged:

FOW HEK LIP XAT VUJ

Hence, second word from the right is XAT.

Answers:

- 11. a
- 12. c
- 13. b
- 14. a

15. d

Solution 11

Given series

6 8 3 9 3 8 6 8 2 6 2 7 **5 4 3 5 4 7** 4 6 9 2 6 2 5

There are two such even numbers which are immediately followed by an odd number and immediately preceded by a prime number.

Hence, option (a) is correct.

Solution 12

Given series

6 8 3 9 3 8 **6** 8 2 6 2 7 **5** 4 3 5 4 7 4 6 9 2 6 2 5

Sum of all the numbers between 2nd '6' from the left end and 3rd '5' from the right end is

$$(8 + 2 + 6 + 2 + 7) = 25.$$

Hence, option c is correct.

Solution 13

Given series

6 8 **3 9 3 8 6 8 2 6 2 7 5 4 3 5 4 7 4 6 9 2 6 2 5**

There are four prime numbers to the left of 14th element from the right end in the given series.

Hence, option b is correct.

Solution 14

Given series

6 8 3 9 3 8 6 8 2 6 2 7 5 4 3 5 **4 7 4 6 9 2 6 2 5**

There are two such odd numbers, which are immediately followed and immediately preceded by an even number in the given series.

Hence, option a is correct

Solution 15

Given series

6 8 3 9 3 8 **6** 8 2 6 2 7 5 4 **3** 5 4 7 4 6 9 2 6 2 5

'2' is in the middle of 7th number from the left end and 11th number from the right end.

Hence, option d is correct.

Answers:

16. b

Ultra Practice Bundle PDF for All Bank Prelims Exams

17. d

18. a

19. c

20. c

Solution 16

Given arrangement:

W T Y C O K P Q Z B M N A E R I K L G D H F U J X
V R Q T V

So, there are three such consonant which are immediately followed by a vowel and preceded by a consonant i.e. YCO, MNA, HFU.

Hence, option b is correct.

Solution 17

Given arrangement

W T Y C O K P Q Z B M N A E R I K L G D H F U J X
V R Q T V

9th to the right + 4th from left = 13th from the left i.e. A.

Hence, option d is correct.

Solution 18

Given arrangement:

W T Y C O K P Q Z B M N A E R I K L G D H F U J X
V R Q T V

So, 8th letter from the left i.e. Q and 9th letter from the right i.e. F.

Hence, option a is correct.

Solution 19

Given arrangement:

W T Y C O K P Q Z B M N A E R I K L G D H F U J X
V R Q T V

Given series:

CKQ, BNE, ILD

So, according to the pattern FJV must be the next set of alphabets.

Hence, option c is correct.

Solution 20

Given arrangement:

W T Y C O K P Q Z B M N A E R I K L G D H F U J X
V R Q T V

So, if all vowels are dropped from the above arrangement then K is the 13th alphabet from the left end.

Hence, option c is correct.

Answers:

21. d

22. d

23. a

24. c

25. b

Solution 21

Given: KEDU EDRT FHRA ULTP HKED

1) On changing the last letter of each word to the next letter in the English alphabetical series-

KEDV EDRU FHRB ULTQ HKEE

2) It is visible that in the series the last word HKEE has two identical vowels. So, there is only one word.

Hence, only one word will be formed having two identical vowels.

Solution 22

Given: KEDU EDRT FHRA ULTP HKED

1) On changing the first letter of each word to the next alphabet in the English alphabetical series-

LEDU FDRT GHRA VLTP IKED

2) It is visible that the words IKED and LEDU are the only words having two different vowels.

Hence, only two words will be formed having two different vowels.

Solution 23

Given: KEDU

Meaningful words that can be made from KEDU-
DUKE

Ultra Practice Bundle PDF for All Bank Prelims Exams

There is only one word that can be made using the word.
Hence, the answer is (1) one.

Solution 24

Given: KEDU EDRT FHRA ULTP HKED

- 1) The third word from the left is FHRA and its second letter is H.
- 2) The second word from the right is ULTP and its second letter is L.
- 3) The alphabets that lie between H and L are 3 i.e. I, J and K.

Hence three is the correct answer.

Solution 25

Given: KEDU EDRT FHRA ULTP HKED

- 1) On arranging the words as per the dictionary on the basis of the last letter-

FHRA HKED ULTP EDRT KEDU

- 2) The second last word is EDRT.

Hence the correct answer is EDRT.

Answers:

26. d

27. a

28. d

29. c

30. a

Solution 26

Given: MFE HTY ELG PSY NOE LZB

- 1) On interchanging first two alphabets of each word
FME THY LEG SPY ONE ZLB
- 2) As we can see there are 4 meaningful words so formed in the series: THY, LEG, SPY, ONE

Hence, four meaningful words are formed.

Solution 27

Given: MFE HTY ELG PSY NOE LZB

- 1) On interchanging first and third letter-

EFM YTH GLE YSP EON BZL

- 2) Arrangement as per dictionary-

BZL EFM EON GLE YSP YTH

So, the second word is EFM which is changed form of MFE.

Hence, MFE is the correct answer.

Solution 28

Given: MFE HTY ELG PSY NOE LZB

- 1) On changing consonants to previous letter and vowel to next letter as per English alphabetical series we get:

LEF GSX FKF ORX MPF KYA

Note: In English alphabetical series there are 5 vowels i.e. A, E, I, O, U else all are consonants

- 2) There are three words with no vowel GSX, FKF and MPF.

Solution 29

Given: MFE HTY ELG PSY NOE LZB

Fourth word from right is ELG and its third letter is G.

Fourth word from the left is PSY and its second letter is S.

Letters between G and S as per English alphabetical series are 11 i.e. H, I, J, K, L, M, N, O, P, Q and R.

Hence, 11 is the correct answer.

Solution 30

Given: MFE HTY ELG PSY NOE LZB

If last two words are interchanged MEF HYT EGL
PYS NEO LBZ

The meaningful word is NEO= which means New

Hence, 1 is the correct answer

Answers:

31. c

32. d

33. e

34. b

35. a

Solution 31

Given words are: TOB UDC RES PFB YWQ

Ultra Practice Bundle PDF for All Bank Prelims Exams

On interchanging both alphabets of each word present at odd positions

BOT **CDU** SER BFP QWY

Clearly, only one word, CDU ending with vowels will be formed.

Note: In English alphabetical series there are 5 vowels i.e. A, E, I, O, U else all are consonants.

Hence, only one word will be formed.

Solution 32

Given words are: TOB UDC RES PFB YWQ

On changing the first and last alphabet of each word to the previous alphabet and the middle alphabet to its next alphabet in the English alphabetical order:

SPA TEB **QFR** OGA **XXP**

Clearly, two words QFR and XXP having only consonants will be formed.

Note: In English alphabetical series there are 5 vowels i.e. A, E, I, O, U else all are consonants.

Hence, two words will be formed.

Solution 33

Given words are: TOB UDC RES PFB YWQ

On arranging words in the order as they appear in a dictionary from left to right, we get:

Left side PFB **RES** TOB UDC YWQ Right side

The fourth word from the right is RES and first and last letters are R and S respectively.

There are no letters in English alphabetical order between R and S

Hence, none is the correct answer.

Solution 34

Given words are: TOB UDC RES PFB YWQ

On arranging alphabets within the word in English alphabetical order:

BOT CDU ERS BFP QWY

Clearly, four words, BOT, ERS, BFP, and YWQ will end with a consonant.

Note: In English alphabetical series there are 5 vowels i.e. A, E, I, O, U else all are

Hence, four words will end with a consonant.

Solution 35

Given words are: TOB UDC RES PFB YWQ

The second word from the left is UDC and its first letter is U

First word from the right is YWQ and its second letter is W

There is only **one** letter between U and W in the English alphabetical series and which is **V**.

Hence, one is the correct answer.

Answers:

36. a

37. c

38. e

39. e

40. d

Solution 36

Given: T H A T I S A W O N D E R F U L S C E N E R Y

New arrangement: S G B S J R B V P M C F Q E V K R B F M F Q Z

Hence, there is only one vowel in the new arrangement.

Solution 37

Given: T H A T I S A W O N D E R F U L S C E N E R Y

Arrangement:

Left side T H A T S C E N E R Y I S A W O N D E R F U L Right side

Hence, N is the 8th letter from the left in the new arrangement.

Solution 38

Given: T H A T I S A W O N D E R F U L S C E N E R Y

23rd letter of the English alphabet is W; immediate left to W is A.

Ultra Practice Bundle PDF for All Bank Prelims Exams

Hence, 'A' is the correct answer.

Solution 39

Given: T H A T I S A W O N D E R F U L S C E N E R
Y

STW: S - 2 → T, S + 2 → W

OAD: O - 2 → A, O + 2 → D

URS: U - 2 → R, U + 2 → S

EEY: E - 2 → C, E + 2 → Y

IAO: I + 2 → A, A + 2 → O

Hence, IAO is the odd one.

Solution 40

Given: T H A T I S A W O N D E R F U L S C E N E R
Y

Alphabet which is 9th to the right of 4th letter from the left end

T H A T I S A W O N D E R F U L S C E N E R Y

Hence, R is the correct answer.

Answers:

41. B

42. c

43. b

44. b

45. c

Solution 41

Left Side: V G C

L X Q D U I T H S F P Z J R N O W Y M B E K A : Right Side

BKY: B - 2 = Y, B + 2 = K,

VCX: V + 2 = X, C + 2 = E

DIX: D - 2 = X, D + 2 = F,

SPT: S - 2 = Q, S + 2 = U,

NWJ: N - 2 = J, N + 2 = W.

Hence odd one is VCX.

Solution 42

Given:

Left Side: V G C

L X Q D U I T H S F P Z J R N O W Y M B E K A : Right Side

Second Vowel is E. K is to the immediate right of E.

Hence, K will be to the immediate right of the 2nd vowel of the English alphabet

Solution 43

Given series:

Left Side: V G C

L X Q D U I T H S F P Z J R N O W Y M B E K A : Right Side

New Arrangement: six letters from the left end are placed between the seventh and the eighth letters from the right end.

Left Side: D U I T H S F P Z J R N O V G C L X Q
W Y M B E K A : Right Side

Left Side: D U I T H S F P Z J R N O V G C L X Q
W Y M B E K A : Right Side

fifth letter to the right of the twelfth letter from the left is L.

Hence, the letter will be L.

Solution 44

Given Series: V G C L X Q D U I T H S F P Z J R N O W Y M B E K A

Alphabet which is 8th to the left of 3rd letter from the right end

V G C L X Q D U I T H S F P Z J R N O W Y M B E K A

Hence, J is the correct answer.

Solution 45

Given Series: V G C L X Q D U I T H S F P Z J R N O W Y M B E K A

7th letter of the English alphabet in the arrangement is G.

Immediate left of G is V.

Hence, V is the correct answer.

Ultra Practice Bundle PDF for All Bank Prelims Exams

Answers:

46. a

47. c

48. b

49. e

50. b

Solution 46

Given series: **A C E U H D S V Z P O J G R Y N L K B W T**

There are four vowels in the given series: A, E, U, O

Left Side: **A C E U H D S V Z P O J G R Y N L K B W**
T : Right Side

Only E and U are adjacent to each other.

Therefore, E is immediately followed by U.

Hence, only one vowel is immediately followed by another vowel.

Solution 47

Given series: **A C E U H D S V Z P O J G R Y N L K B W T**

There are four vowels in the given series: A, E, U, O

Left Side: **A C E U H D S V Z P O J G R Y N L K B W**
T: Right Side

First vowel from the right end: O

The letter third to the left of O: V.

Hence, 'V' is the correct answer.

Solution 48

Given Series: **A C E U H D S V Z P O J G R Y N**
L K B W T

Given series written in English Alphabetical order:-

A B C D E G H J K L N O P R S T U V W Y Z

Given Series	A	C	E	U	H	D	S	V	Z	P	O	J	G	R	Y	N	L	K	B	W	T
Given series written in English Alphabetical order	A	B	C	D	E	G	H	J	K	L	N	O	P	R	S	T	U	V	W	Y	Z

Letters A and R do not change their position.

Hence, two letters do not change their position.

Solution 49

Given series,

Left Side: **A C E U H D S V Z P O J G R Y N L K B W**
T: Right Side

Sixth letter from the right end: N

Seventh letter from left end: S

In the English alphabetical series, there are four letters between N and S: O, P, Q, R.

Hence, there are 'four' letters in the English alphabetical series between the sixth letter from the right end and the seventh letter from the left end.

Solution 50

Given series,

Left Side: **A C E U H D S V Z P O J G R Y N L K B W**
T: Right Side

1) $C + 1 \rightarrow E$; $E + 2 \rightarrow H$

2) $V + 1 \rightarrow Z$; $Z + 3 \rightarrow J$

3) $D + 1 \rightarrow S$; $S + 2 \rightarrow Z$

4) $R + 1 \rightarrow Y$; $Y + 2 \rightarrow L$

5) $J + 1 \rightarrow G$; $G + 2 \rightarrow Y$

VZJ does not belong to the group.

Hence, 'VZJ' is the correct answer.

10. Coding Decoding

Direction (1-5): Study the following information carefully and answer the questions given below:

In a certain code of language,

“Banks are digital today” is written as “Lkd, Mkd, Kkd, Tkd”

“Amount sent through banks” is written as “Dkd, Kkd, Skd, Fkd”

“Digital amount normal today” is written as “Skd, Lkd, Tkd, Bkd”

“Today we sent principal” is written as “Dkd, Xkd, Vkd, Lkd”

1) What is the code for the word “Through”?

- a. Bkd
- b. Vkd
- c. Fkd
- d. Either Bkd or Vkd
- e. None of these

2) What is code of “Banks are normal today”?

- a. KkdBkdMkdTkd
- b. KkdLkdMkdTkd
- c. KkdBkdMkdLkd
- d. KkdMkdXkdVkd
- e. None of these

3) The code “Dkd” represents which of the following word?

- a. Sent
- b. Banks

- c. Digital
- d. Amount
- e. None of these

4) What is the code for the word “Principal”?

- a. Vkd
- b. Bkd
- c. Xkd
- d. Can't be determined
- e. Tkd

5) Which of the following pair is correct?

- a. Today-Mkd
- b. Are-Mkd
- c. Sent-Skd
- d. Digital-Kkd
- e. All are true

Direction (6-10): Study the following information carefully and answer the questions given below:

In a certain code of language,

‘create your own destiny’ is written as ‘five six four two’

‘destiny matter lot own’ is written as ‘nine three two four’

‘does own work out’ is written as ‘ten four one seven’

‘work seem your matter’ is written as ‘eight seven five nine’

6) What is the code for ‘destiny’ in the given code language?

Ultra Practice Bundle PDF for All Bank Prelims Exams

- a. nine
- b. six
- c. seven
- d. two
- e. None of these

7) What is the code for 'lot' in the given code language?

- a. two
- b. three
- c. five
- d. six
- e. eight

8) What is possible code for 'create matter'?

- a. ten eight
- b. six five
- c. three one
- d. six nine
- e. None of these

9) What is the code for 'seem out lot'?

- a. three four five
- b. ten eight three
- c. six nine three
- d. eight three one
- e. either (b) or (d)

10) The code 'one' is coded for which of the following word?

- a. does

- b. Seem
- c. out
- d. either (a) or (c)
- e. Your

Direction (11-15): Study the following information carefully and answer the questions given below:

In a certain language,

'tree that green work' is coded as 'gui, nui, pui, cui'

'work around the garden' is coded as 'xui, cui, yui, bui'

'tree never lie around' is coded as 'kui, pui, mui, xui'

'that the lie' is coded as 'gui, mui, yui'

11) How is the word 'green' coded in the given language?

- a. nui
- b. mui
- c. pui
- d. yui
- e. None of these

12) Which of the following could be coded as 'yui'?

- a. lie
- b. never
- c. the
- d. garden
- e. None of these

13) Which of the following words is coded as 'kui' in the given language?

- a. Work

Ultra Practice Bundle PDF for All Bank Prelims Exams

- b. That
- c. Garden
- d. Never
- e. Either (a) or (c)

14) How is the sentence 'tree work' coded in the given language?

- a. xuimui
- b. pui cui
- c. yuixui
- d. guinui
- e. Either (a) or (d)

15) Which of the following could be coded as 'xui'?

- a. That
- b. Around
- c. Lie
- d. Tree
- e. None of these

Direction (16-20): Study the following information carefully and answer the questions given below:

In a certain language,

'located in remote area' is coded as 'not, fan, did, can'

'area located near forest' is coded as 'pan, can, lan, did'

'forest along remote villages' is coded as 'lan, see, fan, how'

'villages near covered forest' is coded as 'you, lan, see, pan'

16) Which of the following is the code for 'forest' in the given language?

- a. can
- b. how
- c. you
- d. pan
- e. None of these

17) Which of the following words is coded as 'fan' in the given language?

- a. in
- b. along
- c. villages
- d. remote
- e. None of these

18) Which of the following is coded as 'did'?

- a. near
- b. forest
- c. area
- d. located
- e. either (c) or (d)

19) What is the code of 'near' in the given language?

- a. pan
- b. did
- c. sees
- d. you



Ultra Practice Bundle PDF for All Bank Prelims Exams

e. None of these

20) What may be coded as 'not how'?

a. forest in

b. area along

c. along in

d. villages in

e. None of these

Direction (21-25): Study the following information carefully and answer the questions given below:

In a certain language,

'stone and pebble there' is coded as 'tui mui pui kui'

'there every actions over' is coded as 'bui yui kui dui'

'over stone here also' is coded as 'xui dui pui nui'

'also and every each' is coded as 'mui bui cui nui'

21) How is the word 'there' coded in the given language?

a. tui

b. kui

c. nui

d. cui

e. None of these

22) Which of the following could be coded as 'cui'?

a. over

b. every

c. each

d. here

e. None of these

23) Which of the following words is coded as "mui" in the given language?

a. also

b. stone

c. and

d. over

e. None of these

24) How is the sentence 'here actions' coded in the given language?

a. yui, cui

b. xui, yui

c. tui, xui

d. xui, kui

e. None of these

25) Which of the following could be coded as 'kui'?

a. and

b. there

c. pebble

d. here

e. None of these

Direction (26-30): Study the following information carefully and answer the questions given below:

In a certain language,

'database access for all' is coded as 'snr, lmo, kpc, rtp'

Ultra Practice Bundle PDF for All Bank Prelims Exams

'access your database account' is coded as 'dkm, rtp, krt, snr'

'bank for account handling' is coded as 'kpc, bzx, psr, dkm'

'easy handling database account' is coded as 'bzx, efn, dkm, rtp'

26) Which of the following is the code for 'handling' in the given language?

- a. psr
- b. bzx
- c. efn
- d. rtp
- e. None of these

27) Which of the following words is coded as 'kpc' in the given language?

- a. for
- b. access
- c. bank
- d. account
- e. None of these

28) Which of the following is coded as 'rtp'?

- a. access
- b. your
- c. handling
- d. easy
- e. None of these

29) What is the code of 'account' in the given language?

- a. psr
- b. rtp
- c. kpc
- d. dkm
- e. None of these

30) What may be coded as "snr stp"?

- a. for account
- b. account bank
- c. access data
- d. your data
- e. database for

Direction (31-35): Study the following information carefully and answer the given questions.

In a certain code language,

'shock supervise capital deal' means 'ha ma ga ta'

'leader victim accuse shock' means 'fa ca ma ba'

'increase capital supervise victim' means 'ba ga ta ja'

'fresh shock corner deal' means 'ka ha ma va'

31) Which of the following is coded as 'ca'?

- a. supervise
- b. leader
- c. capital
- d. accuse

Ultra Practice Bundle PDF for All Bank Prelims Exams

e. cannot be determined

32) What is the code for 'victim increase'?

- a. gaka
- b. ta ja
- c. faga
- d. baja
- e. kaja

33) What is the code for 'corner' in that language?

- a. ja
- b. va
- c. ga
- d. ka
- e. either b or d

34) Which of the following is coded as 'faca' in that language?

- a. fresh increase
- b. leader accuse
- c. supervise victim
- d. corner shock
- e. fresh deal

35) What is the code for 'Capital'?

- a. ba
- b. ja
- c. ga
- d. ta

e. either c or d

Direction (36-40): Study the following information carefully and answer the given questions.

In a certain language,

'shut apart from distance' is coded as 'three five one six'

'along with from shall' is coded as 'four five two seven'

'shall apart gone forever' is coded as 'seven three nine ten'

'forever with apart shut' is coded as 'two three one ten'

36) How is the 'distance' coded in the given language?

- a. four
- b. seven
- c. ten
- d. six
- e. None of these

37) Which of the following is coded as 'nine'?

- a. gone
- b. forever
- c. apart
- d. shut
- e. None of these

38) Which of the following words is coded as "three" in the given language?

- a. shut
- b. from
- c. apart
- d. shall

Ultra Practice Bundle PDF for All Bank Prelims Exams

e. None of these

39) How is the sentence 'gone forever' coded in the given language?

a. three one

b. two seven

c. three six

d. nine ten

e. Cannot be determined

40) Which of the following could be coded as 'with'?

a. two

b. three

c. nine

d. ten

e. Cannot be determined

Direction (41-45): Study the following information carefully and answer the given questions.

In a certain code of language,

'place satellite on earth' is written as 'jo ki la si'

'earth moon on circle' is written as 'bp la mi jo'

'circle orbit through satellite' is written as 'si dv ut bp'

'moon navigation gone through' is written as 'js mi dv hm'

41) What is the possible code of 'place moon school' in the given code language?

a. ki jo mi

b. mi la jo

c. ki mi si

d. ki mi xi

e. ki mi dv

42) What is the code for 'circle' in the given code of language?

a. ut

b. bp

c. mi

d. lo

e. ja

43) The code 'js' stands for which of the following word?

a. Either 'navigation' or 'circle'

b. Either 'gone' or 'place'

c. Either 'gone' or 'navigation'

d. Either 'earth' or 'circle'

e. None of these

44) What is the code for 'earth' in the given code language?

a. jo

b. mi

c. la

d. Either jo or la

e. None of these

45) What is the code for 'orbit' in the given code of language?

a. si

b. dv

c. ut

d. bp

Ultra Practice Bundle PDF for All Bank Prelims Exams

e. None of these

Direction (46-50): Study the following information carefully and answer the given questions.

In a code language,

“are there secure promise” is coded as “20E 19G 18C 21F”

“wear donate helped tolerate” is coded as “16F 23D 20H 20F”

“kinship sentence number for” is coded as “19G 18C 20H 21F”

“fives blue compact pursue” is coded as “21D 21F 20G 22E”.

46) How is the word “sanction” coded?

- a. 20H
- b. 20G
- c. 20E
- d. 18H
- e. None of these

47) “21G” is the code for _____.

- a. around
- b. envy
- c. custurd

d. offers

e. None of these

48) Which among the following is correctly matched?

- a. will – 22F
- b. yard – 24D
- c. system – 23G
- d. marinate – 20H
- e. former – 19G

49) What is the code for “secure area”?

- a. 17G 18F
- b. 21F 18D
- c. 17F 18G
- d. 17J 19D
- e. None on these

50) How is the word “compact” coded?

- a. 21D
- b. 21F
- c. 20G
- d. 22E
- e. None of these

Solution with Explanation

Answers:

- 1. c
- 2. c
- 3. a

4. d

5. b

Solutions 1-5



Ultra Practice Bundle PDF for All Bank Prelims Exams

Banks are digital today
 Amount sent through banks
 Digital amount normal today
 Today we sent principal

Lkd Mkd Kkd Tkd
 Dkd Kkd Skd Fkd
 Skd Lkd Tkd Bkd
 Dkd Xkd Vkd Lkd

Answers:

- 6. d
- 7. b
- 8. d
- 9. e
- 10. d

Solutions 6-10

create your own destiny five six four two
 destiny matter lot own nine three two four
 does own work out ten four one seven
 work seem your matter eight seven five nine

Answers:

- 11. a
- 12. c
- 13. d
- 14. b
- 15. b

Solutions 11-15

tree that green work
 work around the garden
 tree never lie around
 that the lie

gui nui pui cui
 xui cui yui bui
 kui pui mui xui
 gui mui yui

Answers:

- 16. e
- 17. d
- 18. e
- 19. a
- 20. c

Solutions 16-20

located in remote area not fan did can
 area located near forest pan can lan did
 forest along remote villages lan see fan how
 villages near covered forest you lan see pan

Answers:

- 21. b
- 22. c
- 23. c
- 24. b



Ultra Practice Bundle PDF for All Bank Prelims Exams

25. b

Solutions 21-25

stone and pebble there
 there every actions over
 over stone here also
 also and every each

tui mui pui kui
 bui Yui kui dui
 xui dui pui nui
 mui bui cui nui

Answers:

26. b

27. a

28. e

29. d

30. c

Solutions 26-30

database access for all
 access your database account
 bank for account handling
 easy handling database account

snr lmo kpc rtp
 dkm rtp krt snr
 kpc bzx psr dkm
 bzx efn dkm rtp

Answers:

31. e

32. d

33. e

34. b

35. e

Solutions 31-35

shock supervise capital deal ha ma ga ta
 leader victim accuse shock fa ca ma ba
 increase capital supervise victim ba ga ta ja
 fresh shock corner deal ka ha ma va

Answers:

36. d

37. a

38. c

39. d

40. a

Solutions 36-40

shut apart from distance three five one six
 along with from shall four five two seven
 shall apart gone forever seven three nine ten
 forever with apart shut two three one ten

Answers:

41. d

42. b

43. c

44. d

45. c

Ultra Practice Bundle PDF for All Bank Prelims Exams

Solutions 41-45

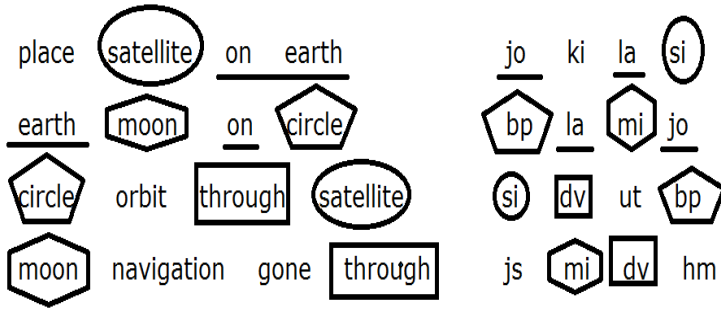

Answers:

- 46. a
- 47. c
- 48. d
- 49. b
- 50. c

Solutions 46-50

In each code, the number before the letter, is the highest number representation of any letter in the word as per alphabetical series.

The letter is the alphabet (in the alphabetical series) of the number of letters in the word. Example: If there are six letters in the word, 6th letter in the alphabetical series is F.

Example:

‘there’

The letter with the highest value in alphabetical series is T, which represents 20.

There are five letters in the word, so 5th letter in the alphabetical series is E.

Therefore, the code for ‘profile’ is ‘20E’.

11. Inequality

Directions (1-50): In the following question, assuming the given statements to be true, find which of the given conclusions is/are definitely true and then choose the right option accordingly.

1. Statements:

$R > S > T; R > F > B.$

Conclusions:

- I. $B > S$
- II. $F < T$
- a) Only I is true
- b) Only II is true
- c) Both I & II are true
- d) Neither I nor II is true

e) Either I or II is true

2. Statement:

$W > D \geq C = X < A < Z \leq F$

Conclusion:

- I. $Z > C$
- II. $X < W$
- a) None is true
- b) Only II is true
- c) Only I is true
- d) Both I and II are true
- e) Either I or II is true

3. Statement:

Ultra Practice Bundle PDF for All Bank Prelims Exams

$$L \geq M = N < O, P < Q \geq R = S \geq L$$

Conclusion:

I. $Q > M$

II. $N = Q$

- a) None is true
- b) Only II is true
- c) Only I is true
- d) Both I and II are true
- e) Either I or II is true

4. Statements:

$$D \geq E > F = A \leq U < L \geq T = R$$

Conclusions:

I. $F < L$

II. $D > A$

- a) None is True
- b) Both I and II are True
- c) Only II is True
- d) Only I is True
- e) Either I and II is True

5. Statements:

$$J \geq N \leq T; T = S > R; K > V \geq J$$

Conclusions:

I. $V \geq N$

II. $K > J$

- a) Only II is true
- b) Only I is true

- c) Either I or II is true
- d) Both I and II are true
- e) None of these

6. Statements:

$$Q \leq R; S < T; P > Q; R > S$$

Conclusions:

I. $S = Q$

II. $T \geq P$

- a) Only I is true
- b) Only II is true
- c) Either I or II true
- d) Neither I nor II is true
- e) Both I and II is true

7. Statement:

$$X < C, W > D, G \geq W, C = D$$

Conclusion:

I. $C \leq G$

II. $W > X$

- a) None is true
- b) Only II is true
- c) Both I and II are true
- d) Only I is true
- e) Either I or II is true

8. Statements:

$$M > A \leq T < D; R > G = A; O \geq T = N;$$

Conclusions:

Ultra Practice Bundle PDF for All Bank Prelims Exams

- I. $T < R$
II. $N < R$
III. $A = N$
- a) Only I and II are true
b) Only I is true
c) Only III is true
d) Only II is true
e) None is true
- 9. Statements:**
- $B \geq C = D \geq E ; A \leq F \leq P = D$
- Conclusions:**
- I. $D \geq A$.
II. $B \geq F$.
- a) Only conclusion I is true.
b) Only conclusion II is true.
c) Either conclusion I or conclusion II is true.
d) Neither conclusion I nor conclusion II is true
e) Both conclusions I and II are true.
- 10. Statements:**
- $P = S < T \leq U ; Q \leq U = A \geq B$
- Conclusions:**
- I. $Q = B$
II. $S \leq A$
- a) Only conclusion I is true.
b) Only conclusion II is true.
c) Either conclusion I or conclusion II is true.
- d) Neither conclusion I nor conclusion II is true.
e) Both conclusions I and II are true.
- 11. Statement:**
- $U < V < W ; Z \leq T = S < V ; X > W \leq A ;$
- Conclusions:**
- I. $S > Z$
II. $T < W$
III. $T < A$
- a) Only I is true
b) Only II is true
c) Only III is true
d) Only II and III are true
e) None is true
- 12. Statements:**
- $B < Q = F \leq N, F \geq L \geq S, B \geq K$
- Conclusions:**
- I. $N \geq S$
II. $F > K$
III. $B < F \geq S$
- a) Only I is true
b) Only II is true
c) Only I and II are true
d) All I, II and III are true
e) Only II and III are true
- 13. Statement:**
- $D = A < C > B > D$

Ultra Practice Bundle PDF for All Bank Prelims Exams

Conclusions:I. $C > A$ II. $D < B$

- a) Only II follows
- b) Both follow
- c) Either I or II follows
- d) Neither I nor II follows
- e) Only I follows

14. Statement: $Z < M \geq Y \geq N > L$ **Conclusion:**I. $Z < L$ II. $M > L$

- a) Both follow
- b) Only I follows
- c) Only II follows
- d) Either I or II follows
- e) Neither I nor II follows

15. Statement: $D > F \geq G \geq H \geq I > J$ **Conclusions:**I. $D > I$ II. $I \leq F$

- a) Only I follows
- b) Only II follows
- c) Either I or II follows

d) Neither I nor I follows

e) Both follow

16. Statements: $Y \leq U > T; W < Q > P; G > U < P$ **Conclusions:**I. $Q > T$ II. $G > Y$ III. $G > T$

- a) Only conclusion II is true.
- b) Both conclusions II and III are true.
- c) All the conclusions I, II and III are true.
- d) Only conclusion I is true
- e) None is true.

17. Statements: $T > Y \geq E < C; W > E = N > J; S \leq Q < J$ **Conclusions:**I. $C > Q$ II. $N \leq Y$ III. $W > S$

- a) Only conclusion II is true
- b) Only conclusion I is true
- c) Both conclusions I and III is true
- d) All of the conclusions are true
- e) Both conclusions I and II are true

18. Statements: $I > O < A; Q \leq O > R; E > Q \geq P > C$

Ultra Practice Bundle PDF for All Bank Prelims Exams

Conclusions:

I. $I \geq C$

II. $A > P$

III. $A \geq E$

- a) Only conclusion I is true
- b) Only conclusion II is true
- c) Both conclusions I and III is true
- d) None of the conclusions is true
- e) Both conclusions I and II are true

19. Statements: $O \geq D \leq J < L$; $D > G \geq B \geq F > K > T$

Conclusions:

I. $L \geq K$

II. $O > T$

III. $J \geq B$

- a) Only conclusion II is true
- b) Only conclusion I is true
- c) Both conclusions I and III is true
- d) None of the conclusions is true
- e) Both conclusions I and II are true

20. Statements:

$T \geq W > S > G$; $B > N = W \leq L < U \leq K$

Conclusions:

I. $B > S$

II. $K = T$

III. $U > G$

- a) Only conclusion I is true

- b) Only conclusion II is true
- c) Both conclusions I and III is true
- d) None of the conclusions is true
- e) Both conclusions I and II are true

21. Statements:

$Y \geq E \leq D < P$; $E > S \geq Q > O > F \geq B$

Conclusions:

I. $Y \geq F$

II. $P \geq B$

III. $D > F$

- a) Only conclusion I is true
- b) Only conclusion III is true
- c) Both conclusions I and III is true
- d) None of the conclusions is true
- e) Both conclusions I and II are true

22. Statements:

$P \leq R < T$; $G \geq Z = F$; $B < M = G \geq R$

Conclusions:

I. $F \leq M$

II. $P \leq G$

III. $B < R$

- a) Only conclusion II is true.
- b) Both conclusions II and III are true.
- c) All the conclusions are true.
- d) Both conclusions I and II are true.
- e) None is true.

Ultra Practice Bundle PDF for All Bank Prelims Exams

23. Statement:

$Z \geq Q; U > V; Z \geq O; Q \geq U; I = Q$

Conclusions:

I. $U > O$

II. $O > Q$

III. $Q > V$

- a) Both conclusions II and III are true
- b) Only conclusion I is true
- c) Only conclusion III is true
- d) Only conclusion II is true
- e) Both the conclusions I and III are true

24. Statement:

$E > K \leq T; D > X; I \geq T \leq F > X$

Conclusions:

I. $I > X$

II. $I \geq F$

III. $D > T$

- a) Both conclusions II and III are true
- b) Only conclusion I is true
- c) Only conclusion III is true
- d) Only conclusion II is true
- e) None of the conclusions follows

25. Statements:

$E > T \leq R; C < R > I; G > E$

Conclusions:

I. $G > C$

II. $T \leq I$

III. $G > T$

- a) Only conclusion II is true
- b) Both conclusions II and III are true
- c) Only conclusion III is true
- d) Only conclusion I is true
- e) None is true

26. Statements:

$Q > T; Y \geq R < L; Q = J; J < L$

Conclusion:

I. $Y > T$

II. $L > T$

III. $R > Q$

- a) Only conclusion II is true.
- b) Both conclusions II and III are true.
- c) Only conclusion III follows.
- d) Only conclusion I is true
- e) None is true.

27. Statement:

$R \geq T > Y = I; O < L; L \leq T$

Conclusions:

I. $R > O$

II. $L > I$

III. $O > R$

- a) Only conclusion II is true.
- b) Both conclusions II and III are true.

Ultra Practice Bundle PDF for All Bank Prelims Exams

- c) Only conclusion III follows.
- d) Only conclusion I is true
- e) None is true.

28. Statements:

$E > Q \leq V; T > U < Q; E = C$

Conclusions:

- I. $C > U$
 - II. $V > U$
 - III. $T > E$
- a) Only conclusion II is true.
 - b) Both conclusions I and II are true.
 - c) Only conclusion III follows.
 - d) Only conclusion I is true
 - e) None is true.

29. Statements:

$P > Q > R \leq T; O \geq P; Y < R = X$

Conclusions:

- I. $O \geq X$
 - II. $P > Y$
 - III. $T > P$
- a) Only conclusion II is true.
 - b) Both conclusions I and II are true.
 - c) Only conclusion III follows.
 - d) Only conclusion I is true
 - e) None is true.

30. Statements:

$W > B < M; D > V = B; 9 > 8 = W$

Conclusions:

- I. $9 > B$
 - II. $W > M$
 - III. $D > 9$
- a) Only conclusion II is true.
 - b) Both conclusions II and III are true.
 - c) Only conclusion III follows.
 - d) Only conclusion I is true
 - e) None is true.

31. Statements:

$I \geq S = U, O = U, I = M = P$

Conclusions:

- 1. $I \geq O$
 - 2. $U \leq I$
- a) Only 1 follows
 - b) Only 2 follows
 - c) Both 1 and 2 follow
 - d) Neither 1 nor 2 follow
 - e) Either 1 or 2 follows

32. Statements:

$R \geq K \geq F, D > F, R \geq C \leq S$

Conclusions:

- 1. $D > K$
 - 2. $R \geq F$
- a) Only 1 follows



Ultra Practice Bundle PDF for All Bank Prelims Exams

- b) Only 2 follows
- c) Both 1 and 2 follow
- d) Neither 1 nor 2 follow
- e) Either 1 or 2 follows

33. Statements:

$B < H, X = C \geq P, X > N < H$

Conclusions:

1. $N > B$
 2. $C \geq H$
- a) Only 1 follows
 - b) Only 2 follows
 - c) Both 1 and 2 follow
 - d) Neither 1 nor 2 follow
 - e) Either 1 or 2 follows

34. Which of the following symbols should replace the question marks respectively so that 'F < P' is definitely true?

$P ? Q = R ? S = F < T > U$

- a) < and >
- b) > and =
- c) > and >
- d) > and <
- e) < and <

35. Which of the following symbols should replace the question marks respectively so that $G > C$ is definitely true?

$G > F ? B = R ? A = C < Q > D$

- a) < and >

- b) > and <
- c) > and >
- d) > and <
- e) < and <

36. Which of the following order of letters (from left to right) in the blanks makes the expression, $L > G$ definitely true?

_____ > _____ = _____ ≤ _____ = _____

- a) L,A,O,S,G
- b) L,S,G,O,A
- c) G,L,O,S,A
- d) G,O,A,L,S
- e) L,S,A,G,O

37. If $O \geq U > R \leq S$ and $T \geq U > M < L$ are true, which of the following options is neither definitely true nor definitely false?

- a) $O > M$
- b) $R < T$
- c) $S > L$
- d) $T < R$
- e) None of these

38. Statements:

$W \leq K, H > T \geq L, K = C \geq X, H < Y = X, A > L$

Conclusions:

1. $A > X$
 2. $C > L$
- a) Only 1 follows
 - b) Only 2 follows

Ultra Practice Bundle PDF for All Bank Prelims Exams

- c) Both 1 and 2 follow
 d) Neither 1 nor 2 follow
 e) Either 1 or 2 follows

39. Statements:

$$J \leq Q, O > P = C, R \geq X < Q, G = O, R < D \geq C$$

Conclusions:

1. $J > C$
2. $C \geq Q$

- a) Only 1 follows
 b) Only 2 follows
 c) Both 1 and 2 follow
 d) Neither 1 nor 2 follow
 e) Either 1 or 2 follows

40. Statements:

$$T = X, S = O < B, S \geq P = A, X < U < A, R > B$$

Conclusions:

1. $A < R$
2. $P < B$

- a) Only 1 follows
 b) Only 2 follows
 c) Both 1 and 2 follow
 d) Neither 1 nor 2 follow
 e) Either 1 or 2 follows

41. If $E < G$ and $O < G$ are definitely true then which of the following symbols should be placed in the blank spaces respectively?

$$D > E _ F = G > B = N _ O$$

- a) $<, >$
 b) $<, >$
 c) $<, =$
 d) $>, >$
 e) None of these

42. In which of the given expression does the expression $N > Q$ and $L > P$ definitely hold True?

- a) $L > M \geq N < O = P \leq Q < R$
 b) $L > M \geq N > O = P \leq Q < R$
 c) $L > M \geq N > O = P \geq Q < R$
 d) $L > M \geq N \leq O = P \leq Q < R$
 e) $L \geq M \geq N \geq O = P \geq Q < R$

43. If $M \leq A = T < C$; $U > P \geq T < K$ and $X > A > N$ are true, which of the following options is definitely true?

- a) $U < T$
 b) $C \geq N$
 c) $X < P$
 d) $N < K$
 e) All the options are false

44. If $M > C \geq D$; $S \leq C < A \leq N$ and $K \geq B > A$ are true, which of the following options is definitely true?

- a) $K > N$
 b) $M < S$
 c) $B > S$
 d) $M = N$
 e) $N \geq D$

Ultra Practice Bundle PDF for All Bank Prelims Exams

45. Which of the following symbols should replace the question mark in the given expression in order to make the expressions 'K ≤ H' and 'M > J' definitely true ? $H \geq I = J ? K \leq L < M$

- a) >
- b) ≥
- c) ≤
- d) Either < or ≤
- e) =

Directions (46 – 50): Relationship between different elements is shown in the statements. Find if the conclusions also follow or not.

46. Statements:

$$W > S \leq Q, D \leq S, I \leq B = D$$

Conclusions:

- I. $Q \geq I$
- II. $Q = I$

- a) Only I follows
- b) Only II follows
- c) Either I or II follows
- d) Neither I nor II follow
- e) Both I and II follow

47. Statements:

$$Q < D \leq A, C > A < K, D \geq S$$

Conclusions:

- I. $K > D$
- II. $C > S$

- a) Only I follows

- b) Only II follows
- c) Either I or II follows
- d) Neither I nor II follow
- e) Both I and II follow

48. Statements:

$$S > N \geq F, P = N, E > S$$

Conclusions:

- I. $E > P$
- II. $F < E$

- a) Only I follows
- c) Only II follows
- c) Either I or II follows
- d) Neither I nor II follow
- e) Both I and II follow

49. Statements:

$$E \geq L > K, L > F < D, P > E$$

Conclusions:

- I. $P > D$
- II. $E > F$

- a) Only I follows
- b) Only II follows
- c) Either I or II follows
- d) Neither I nor II follow
- e) Both I and II follow

50. Statements:

$$Q \geq X \geq S, S < A, A > E$$

Ultra Practice Bundle PDF for All Bank Prelims Exams

Conclusions:

I. $E > X$

II. $X \geq E$

a) Only I follows

b) Only II follows

c) Either I or II follows

d) Neither I nor II follow

e) Both I and II follow

Answers with Explanation:

1. Answer: D)

Given statements: $R > S > T; R > F > B$

On combining: $B < F < R > S > T$

Conclusions:

I. $B > S \rightarrow$ False (as $B < F < R > S > T \rightarrow B < R > S \rightarrow$ thus clear relation between B and S can't be determined)

II. $F < T \rightarrow$ False (as $B < F < R > S > T \rightarrow F < R > T \rightarrow$ thus clear relation between F and T can't be determined)

Hence, neither conclusion I nor II is true.

2. Answer: D)

Given Statements: $W > D \geq C = X < A < Z \leq F$

Conclusions: I. $Z > C \rightarrow$ True (as $C = X < A < Z \rightarrow C < Z$)

II. $X < W \rightarrow$ True (as $W > D \geq C = X \rightarrow W > X$)

Hence, both I and II are true.

3. Answer: E)

Given Statements: $L \geq M = N < O, P < Q \geq R = S \geq L$

On combining: $P < Q \geq R = S \geq L \geq M = N < O$

Conclusions: I. $Q > M \rightarrow$ False (as $Q \geq R = S \geq L \geq M \rightarrow Q \geq M$)

II. $N = Q \rightarrow$ False (as $Q \geq R = S \geq L \geq M = N \rightarrow Q \geq N$)

In statement 'N = M'

Hence, either I or II is true.

4. Answer: B)

Given statements: $D \geq E > F = A \leq U < L \geq T = R$

Conclusions:

I. $F < L \rightarrow$ True (as $D \geq E > F = A \leq U < L \geq T = R$)

II. $D > A \rightarrow$ True (as $D \geq E > F = A \leq U < L \geq T = R$)

Therefore, both conclusions follow.

5. Answer: D)

Statements: $J \geq N \leq T; T = S > R; K > V \geq J$

On combining: $K > V \geq J \geq N \leq T = S > R$

Conclusions:

I. $V \geq N \rightarrow$ True (As $V \geq J \geq N$)

II. $K > J \rightarrow$ True (As $K > V \geq J$)

Thus, Both I and II are true.

6. Answer: D)

Given statements: $Q \leq R; S < T; P > Q; R > S$

On combining: $P > Q \leq R > S < T$

Conclusions:

Ultra Practice Bundle PDF for All Bank Prelims Exams

I. $S = Q \rightarrow$ False (as $Q \leq R > S$, so a definite relation between S and Q cannot be determined)

II. $T \geq P \rightarrow$ False ($P > Q \leq R > S < T$, so a definite relation between T and P cannot be determined)

Hence, neither I nor II is true.

7. Answer: B)

Given Statements: $X < C, W > D, G \geq W, C = D$

On combining: $X < C = D < W \leq G$

Conclusions:

I. $C \leq G \rightarrow$ False (as $C = D < W \leq G \rightarrow C < G$)

II. $W > X \rightarrow$ True (as $X < C = D < W \rightarrow X < W$)

Hence, only II is true.

8. Answer: E)

Statements: $M > A \leq T < D; R > G = A; O \geq T = N;$

On combining: $M > A \leq T = N; R > G = A \leq T < D; O \geq T < D$

Conclusions:

I. $T < R \rightarrow$ False (as $R > G = A \leq T \rightarrow$ Relation between T and R can't be determined)

II. $N < R \rightarrow$ False (as $R > G = A \leq T = N \rightarrow$ Relation between N and R can't be determined)

III. $A = N \rightarrow$ False (as $A \leq T = N$)

Hence, none of the statements is true.

9. Answer: E)

Given statements are: $B \geq C = D \geq E; A \leq F \leq P = D.$

On combining: $B \geq C = D \geq E; B \geq C = D = P \geq F \geq A.$

Conclusions:

I. $D \geq A \rightarrow$ Clearly follows hence true.

II. $B \geq F \rightarrow$ Clearly follows hence true.

Hence both I and II true.

10. Answer: D)

Given statements are: $P = S < T \leq U; Q \leq U = A \geq B.$

On combining: $P = S < T \leq U = A \geq B; P = S < T \leq U \geq Q.$

Conclusions:

I. $Q = B \rightarrow$ The relation between Q and B is not clear. Hence, the conclusion is false.

II. $S \leq A \rightarrow$ Clearly, $S < A$ and doesn't follow $S \leq A$. Hence, the conclusion is false.

11. Answer: D)

Statement: $U < V < W; Z \leq T = S < V; X > W \leq A;$

On combining: $Z \leq T = S < V < W < X; W \leq A; U < V$

I. $S > Z \rightarrow$ False ($Z \leq T = S \rightarrow Z \leq S$)

II. $T < W \rightarrow$ True ($T = S < V < W \rightarrow T < W$)

III. $T < A \rightarrow$ True ($T = S < V < W \leq A \rightarrow T < A$)

Hence, Only II and III are true.

12. Answer: D)

Given statements: $B < Q = F \leq N, F \geq L \geq S, B \geq K$

On combining: $K \leq B < Q < F \geq L \geq S; S \leq L \leq F \leq N$

Conclusions:

I. $N \geq S \Rightarrow$ True (as $S \leq L \leq F \leq N \rightarrow S \leq N$)

II. $F > K \Rightarrow$ True (as $K \leq B < Q < F \geq L \geq S \rightarrow K < F$)

III. $B < F \geq S \Rightarrow$ True (as $B < Q < F$ and $S \leq L \leq F$, so we get, $B < Q = F \geq L \geq S \rightarrow B < F \geq S$)

Hence all the conclusions are true.

13. Answer: B)

Ultra Practice Bundle PDF for All Bank Prelims Exams

Given statement: $D = A < C > B > D$

Conclusions:

- I. $C > A \rightarrow$ True (as $C > B > D = A \rightarrow$ thus $C > A$)
- II. $D < B \rightarrow$ True (as $B > D$)

Hence, both conclusions follow.

14. Answer: C)

Given Statements: $Z < M \geq Y \geq N > L$

Conclusions:

- I. $Z < L \rightarrow$ False (as $Z < M \geq Y \geq N > L \rightarrow$ relation between Z and L cannot be determined)
- II. $M > L \rightarrow$ True (as $M \geq Y \geq N > L \rightarrow M > L$)

Hence, only II follows.

15. Answer: E)

Given Statements: $D > F \geq G \geq H \geq I > J$

Conclusions:

- I. $D > I \rightarrow$ True (as $D > F \geq G \geq H \geq I \rightarrow D > I$)
- II. $I \leq F \rightarrow$ True (as $F \geq G \geq H \geq I \rightarrow F \geq I$)

Hence, both I and II follow.

16. Answer: C)

Given statement

$Y \leq U > T; W < Q > P; G > U < P$

On combining,

$G > U < P < Q > W; G > U \geq Y; G > U > T$

Conclusions:

- I. $Q > T$: True (As $Q > P > U > T$ so, $Q > T$)
- II. $G > Y$: True (As $G > U \geq Y$ so, $G > Y$)
- III. $G > T$: True (As $G > U > T$ so, $G > T$)

17. Answer: D)

Given statements: $T > Y \geq E < C; W > E = N > J; S \leq Q < J$

On combining, we get,

$T > Y \geq E = N > J > Q \geq S; C > E = N > J > Q \geq S; W > E = N > J > Q \geq S$

Conclusions:

- I. $C > Q$: True (As, $C > E = N > J > Q$, so, $C > Q$)
- II. $N \leq Y$: True (As $Y \geq E = N$, so, $Y \geq N$)
- III. $W > S$: True (As, $W > E = N > J > Q \geq S$, so, $W > S$)

18. Answer: B)

Given statements: $I > O < A; Q \leq O > R; E > Q \geq P > C$

On combining, we get,

$I > O > R; A > O > R; I > O \geq Q \geq P > C; A > O \geq Q \geq P > C; A > O \geq Q < E$

Conclusions:

- I. $I \geq C$: False (As, $I > O \geq Q \geq P > C$, so, $I > C$)
- II. $A > P$: True (As $A > O \geq Q \geq P$, so, $A > P$)
- III. $A \geq E$: False (As, $A > O \geq Q < E$, so, the relation between A and E cannot be determined)

19. Answer: A)

Given statements: $O \geq D \leq J < L; D > G \geq B \geq F > K > T$

On combining, we get,

$O \geq D > G \geq B \geq F > K > T; L > J \geq D > G \geq B \geq F > K > T$

Conclusions:

- I. $L \geq K$: False (As, $L > J \geq D > G \geq B \geq F > K$, so, $L > K$)

Ultra Practice Bundle PDF for All Bank Prelims Exams

II. $O > T$: True (As $O \geq D > G \geq B \geq F > K > T$, so, $O > T$)

III. $J \geq B$: False (As, $J \geq D > G \geq B$, so, $J > B$)

20. Answer: C)

Given statements: $T \geq W > S > G$; $B > N = W \leq L < U \leq K$

On combining, we get,

$B > N = W > S > G$; $K \geq U > L \geq W > S > G$; $K \geq U > L \geq W \leq T$

Conclusions:

I. $B > S$: True (As, $B > N = W > S$, so, $B > S$)

II. $K = T$: False (As $K \geq U > L \geq W \leq T$, so, the relation between K and T is not determined)

III. $U > G$: True (As, $U > L \geq W > S > G$, so, $U > G$)

21. Answer: B)

Given statements: $Y \geq E \leq D < P$; $E > S \geq Q > O > F \geq B$

On combining, we get,

$Y \geq E > S \geq Q > O > F \geq B$; $P > D \geq E > S \geq Q > O > F \geq B$

Conclusions:

I. $Y \geq F$: False (As, $Y \geq E > S \geq Q > O > F$, so, $Y > F$)

II. $P \geq B$: False (As, $P > D \geq E > S \geq Q > O > F \geq B$, so, $P > B$)

III. $D > F$: True (As, $D \geq E > S \geq Q > O > F$, so, $D > F$)

22. Answer: D)

Given statements: $P \leq R < T$; $G \geq Z = F$; $B < M = G \geq R$

On combining, we get

$B < M = G \geq Z = F$; $P \leq R \leq G = M > B$

Conclusions:

I. $F \leq M$: True (As $M = G \geq Z = F$, so $F \leq M$)

II. $P \leq G$: True (As $P \leq R \leq G$, so $P \leq G$)

III. $B < R$: False (As $R \leq G = M > B$, relation between B and R cannot be determined)

23. Answer: C)

Given statements:

$Z \geq Q$; $U > V$; $Z \geq O$; $Q \geq U$; $I = Q$

On combining, we get,

$Z \geq Q \geq U > V$ and $O \leq Z \geq Q = I$

Conclusions:

I. $U > O$: False ($O \leq Z \geq Q \geq U$ so, relationship between U and O can't be established)

II. $O > Q$: False ($O \leq Z \geq Q \geq U$ so, relationship between O and Q can't be established)

III. $Q > V$: True ($Z \geq Q \geq U > V$, so $Q > V$)

24. Answer: E)

Given statement

$E > K \leq T$; $D > X$; $I \geq T \leq F > X$

On combining we get,

$E > K \leq T \leq F > X < D$ and $I \geq T \leq F > X$

Conclusions:

I. $I > X$: False ($I \geq T \leq F > X$; so relationship between I and X can't be established)

II. $I \geq F$: False ($I \geq T \leq F > X$, relationship between I and F can't be established)

III. $D > T$: False ($E > K \leq T \leq F > X < D$, relationship between D and T can't be established)

25. Answer: C)

Given:

Ultra Practice Bundle PDF for All Bank Prelims Exams

$E > T \leq R; C < R > I; G > E$

On combining:

$G > E > T \leq R > I$ and $G > E > T \leq R > C$

Conclusions:

I. $G > C$: False (As $G > E > T \leq R > C$ so, the relationship between G and C cannot be established)

II. $T \leq I$: False (As $G > E > T \leq R > C$ so, the relationship between T and I cannot be established)

III. $G > T$: True (As $G > E > T$, so, $G > T$)

26. Answer: A)

Given statement:

$Q > T; Y \geq R < L; Q = J; J < L$

On combining,

$Y \geq R < L > J = Q > T$

Conclusions:

I. $Y > T$: False (As $Y \geq R < L > J = Q > T$ so, the relationship between Y and T cannot be established)

II. $L > T$: True (As $Y \geq R < L > J = Q > T$ so, $L > T$)

III. $R > Q$: False (As $Y \geq R < L > J = Q > T$ so, the relationship between R and Q cannot be established)

27. Answer: D)

Given statement:

$R \geq T > Y = I; O < L; L \leq T$

On combining,

$R \geq T \geq I = L > O$ and $I = Y < T \geq L > O$

Conclusions:

I. $R > O$: True (As $R \geq T \geq I = L > O$ so, $R > O$)

II. $L > I$: False (As $I = Y < T \geq L > O$ so, the relationship between L and I cannot be established)

III. $O > R$: False (As $R \geq T \geq I = L > O$ so, the relationship between O and R cannot be established)

28. Answer: B)

Given statements,

$E > Q \leq V; T > U < Q; E = C$

On combining,

$C = E > Q \leq V$ and $T > U < Q < E = C$

Conclusions:

I. $C > U$: True (As $T > U < Q < E = C$ so, $C > U$)

II. $V > U$: True (As $U < Q \leq V$ so, $V > U$)

III. $T > E$: False (As $T > U < Q < E = C$ so, the relationship between T and E cannot be established)

29. Answer: A)

Given statements:

$P > Q > R \leq T; O \geq P; Y < R = X$

On combining,

$O \geq P > Q > R > Y$ and $T \geq R < Q < P$

Conclusions:

I. $O \geq X$: False (As $O \geq P > Q > R = X$ so, the relationship between O and X cannot be established)

II. $P > Y$: True (As $O \geq P > Q > R > Y$ so, $P > Y$)

III. $T > P$: False (As $T \geq R < Q < P$ so, the relationship between T and P cannot be established)

30. Answer: D)

Given statements:

$W > B < M; D > V = B; 9 > 8 = W$

Ultra Practice Bundle PDF for All Bank Prelims Exams

On combining,

$$9 > 8 = W > B < M \text{ and } D > V = B < M$$

Conclusions:

I. $9 > B$: True ($9 > 8 = W > B < M$ so, $9 > B$)

II. $W > M$: False ($9 > 8 = W > B < M$ so, the relationship between W and M cannot be established)

III. $D > 9$: False ($9 > 8 = W > B = V < D$ so, the relationship between D and 9 cannot be established)

31. Answer: C)

From the given statements we have: $O = U = S \leq I = M = P$

$$O = U = S \leq I$$

From this we have, $I \geq O$ to be True.

$$U = S \leq I$$

From this we have, $U \leq I$ to be True.

32. Answer: B)

From the given statements we have: $D > F \leq K \leq R \geq C \leq S$

$$D > F \leq K$$

Since we have both " \leq " and " $>$ " in the equation, we can't establish the relation between D and K . So, $D > K$ is False.

$$F \leq K \leq R$$

From this we have, $R \geq F$ to be True.

33. Answer: D)

From the given statements we have: $B < H > N < X = C \geq P$

$$B < H > N$$

Since we have both " $<$ " and " $>$ " in the equation, we can't establish the relation between B and N . So, $N > B$ is False.

$$H > N < X = C$$

Since we have both " $<$ " and " $>$ " in the equation, we can't establish the relation between H and C . So, $C \geq H$ is False.

34. Answer: C)

Given; $P ? Q = R ? S = F < T \geq U$

Using option 1: - $P < Q = R > S = F < T \geq U$.

We cannot compare P and F . So, option 1 is incorrect.

Using option 2: - $P \geq Q = R = S = F < T \geq U$

Here, $P \geq F$. So, option 2 is incorrect.

Using option 3: - $P > Q = R \geq S = F < T \geq U$

Clearly, $P > F$. So, option 3 is the correct answer.

Using option 4: - $P \geq Q = R \leq S = F < T \geq U$

We cannot compare P and F . So, option 4 is incorrect.

Using option 5: - $P < Q = R < S = F < T \geq U$

Here, $P < F$. So, option 5 is incorrect.

35. Answer: C)

Given; $G > F ? B = R ? A = C < Q \geq D$

Using option 1: - $G > F < B = R > A = C < Q \geq D$

We cannot compare C and G . So, option 1 is incorrect.

Using option 2: - $G > F \geq B = R \leq A = C < Q \geq D$

We cannot compare C and G . So, option 2 is incorrect.

Using option 3: - $G > F > B = R \geq A = C < Q \geq D$

Clearly, $G > C$. So, option 3 is the correct answer.

Using option 4: - $G > F \geq B = R \leq A = C < Q \geq D$

Ultra Practice Bundle PDF for All Bank Prelims Exams

We cannot compare C and G. So, option 4 is incorrect.

Using option 5: - $G > F < B = R < A = C < Q \geq D$

We cannot compare C and G. So, option 5 is incorrect.

36. Answer: B)

For $L > G$ to be definitely true, L has to be in first position, G has to be in either 2nd or 3rd position.

37. Answer: C)

Option 1: By combining the two statements, we get $O \geq U > M$. From this, we can conclude that $O > M$ which is definitely true.

Option 2: By combining the two statements, we get $T \geq U > R$. From this, we can conclude that $T > R$ which is definitely true.

Option 3: By combining the two statements, we get $S \geq R < U > M < L$. We can't conclude the relation between S and L. Thus, $S > L$ is possible

Option 4: By combining the relevant statements, we get $T \geq U > R$. From this, we can conclude that $T > R$. Thus, $R > T$ is definitely false.

38. Answer: B)

From the given statements we have: $A > L \leq T < H < Y = X \leq C = K \geq W$

$$A > L \leq T < H < Y = X$$

Since we have both " \leq " and " $>$ " in the equation, we cant establish the relation between A and X. So, $A > X$ is False.

$$L \leq T < H < Y = X \leq C$$

From this we have, $C > L$ to be True.

39. Answer: D)

From the given statements we have: $J \leq Q > X \leq R < D \geq C = P < O = G$

$$J \leq Q > X \leq R < D \geq C$$

Since we have both " \leq " and " $>$ " in the equation, we cant establish the relation between J and C. So, $J > C$ is False.

$$Q > X \leq R < D \geq C$$

Since we have both " \leq " and " $>$ " in the equation, we cant establish the relation between Q and C. So, $C \geq Q$ is False.

40. Answer: C)

From the given statements we have: $R > B > O = S \geq P = A > U > X = T$

$$R > B > O = S \geq P = A$$

From this we have, $A < R$ to be True.

$$B > O = S \geq P$$

From this we have, $P < B$ to be True.

41. Answer: B)

From option 1) $D > E \leq F = G \geq B = N \geq O$

G and E's relation not clear

From option 2) $D > E < F = G \geq B = N \geq O$,

Clearly $G > E$ and $G \geq O$ are definitely true. Hence follows.

42. Answer: C)

From option 1) $L > M \geq N < O = P \leq Q < R$

This lead us to $N > Q$, Hence does not follow.

From option 2) $L > M \geq N > O = P \leq Q < R$

This lead us to $N > Q$, Hence does not follow.

From option 3) $L > M \geq N > O = P \geq Q < R$

Clearly $N > Q$ and $L > P$ is true. So this is follow.

43. Answer: D)

Ultra Practice Bundle PDF for All Bank Prelims Exams

Option A: From the statement $U > P \geq T < K$, we can conclude that $U > T$.

Option B: By combining the relevant statements, we get $N < A = T < C$. From this, we can conclude that $C > N$. We can't justify the equality sign.

Option C: By combining the relevant statements, we get $X > A = T \leq P$. From this, we can't conclude whether $X < P$ or not.

Option D: By combining the relevant statements, we get $N < A = T < K$. From this, we can conclude that $N < K$. hence, true.

44. Answer: C)

Option A: By combining the relevant statements, we get $K > B > A \leq N$. From this, we can't conclude the relation between K and N .

Option B: By combining the relevant statements, we get $M > C \geq S$. From this, we can conclude that $M > S$.

Option C: By combining the relevant statements, we get $S \leq C < A < B$. From this, we can conclude that $B > S$.

Option D: By combining the relevant statements, we get $M > C < A \leq N$. From this, we can't conclude if M is equal to N or not.

Option E: By combining the relevant statements, we get $D \leq C < A \leq N$. From this, we can conclude that $N > D$. The equality is not possible.

45. Answer: E)

From Option 1: $H \geq I = J > K \leq L < M$. From this $K < H$

From Option 2: $H \geq I = J \geq K \leq L < M$. From this $K \leq H$, but No relation between M and J

From Option 3: $H \geq I = J \leq K \leq L < M$. No relation is true

From Option 4: $H \geq I = J \leq K \leq L < M$. No relation is true for H and K

From Option 5: $H \geq I = J = K \leq L < M$. Here $K \leq H$ and $M > J$ both follows. So option 5 is the answer.

46. Answer: A)

$Q \geq S \geq D \geq I$.

So $Q \geq I$

47. Answer: E)

$K > A \geq D$, so $K > D$

$C > A \geq D \geq S$ so $C > S$

48. Answer: E)

$E > S > N = P$, so $E > P$

$F \leq N < S < E$, so $F < E$

49. Answer: B)

$P > E \geq L > F < D$, so relation can't be determined between P and D $E \geq L > F$, so $E > F$

51. Answer: C)

$E < A > S \leq X$, so relation can't be determined between E and X , but is for sure that either E is greater than X or is less than equal to X , so either or between the two

Ultra Practice Bundle PDF for All Bank Prelims Exams

12.Directions

Directions (1-3): Answer the questions based on the information given below.

Jatin started walking from point P in east direction. After walking 8m he turns left from point Q. He then walks 3m and turns left from point R. He then walks for 8m and then turns right from point S. He then walks for 5m till point T and then turns right and walks for 8m till point U. He then turns left and walks for 3m and then turns right from point V and walks for 5m till point W. He then turns right from point W and walks for 8m till point X.

1) In which direction is point X with respect to point Q?

- a. North-West
- b. South
- c. West
- d. North-East
- e. South-East

2) What is the shortest distance between point S and point X?

- a. 12m
- b. 13m
- c. 17m
- d. 20m
- e. None of these

3) What is the total distance between V and Q?

- a. 12m
- b. 13m
- c. 11m
- d. 15m
- e. None of these

Direction (4-6): Answer the questions based on the information given below.

Nick started walking in east direction from point M. After walking 4m till point N, he turns right and walks for 6m till point O and then turns left and walks for 3m till point P. He then turns left and walks for 8m till point Q. He then turns right and walks for 4m till point R. He then turns right and walks for 15m till point S. He then turns right and walks for 7m till point T.

4) In which direction is point O with respect to point T?

- a. South
- b. East
- c. North-East
- d. West
- e. None of these

5) What is the total distance that Nick covered?

- a. 45m
- b. 47m
- c. 50m
- d. 52m
- e. None of these

6) In which direction R with respect with M?

- a. South
- b. East
- c. North-East
- d. West
- e. None of these

Directions (7-8): Answer the questions based on the information given below:

Ultra Practice Bundle PDF for All Bank Prelims Exams

Point A is 4m north of point C. Point F is 10m east of point G, which is 5m south of point H. Point B is north of point D, which is west of point E. Point F is 7m north of point E. Point C is the middle point of point B and point H. Point B is 6m to the west of H.

7) What is the shortest distance between point B and point E?

- a. 22m
- b. 20m
- c. 25m
- d. 28m
- e. None of these

8) What is the direction of point G with respect to point D?

- a. North east
- b. North west
- c. South west
- d. North
- e. None of these

Directions (9-11): Answer the questions based on the information given below.

Rahul starts walking from point M in south direction. After walking 6m he turns left from point N and walks for 4m till point O. He then turns left and walks for 9m till point P. He then turns left and walks for 8m till point Q. He then turns left and walks for 3m till point R. He then turns right and walks for 4m till point S. He then turns left and walks for 6m till point T.

9) What is the shortest distance between M and T?

- a. 11m
- b. 12m
- c. 10m
- d. 8m

e. None of these

10) In which direction is point N with respect to point T?

- a. West
- b. North
- c. East
- d. North-East
- e. None of these

11) What is the total distance between T and O?

- a. 11m
- b. 12m
- c. 10m
- d. 8m
- e. None of these

Directions (12-14): Answer the questions based on the information given below.

A is sitting 3m north to B. C is sitting 4m west to H, who is sitting 8m south to E. F is sitting 16m north to C. G is sitting 8m north to D, who is sitting 4m east to B. I is sitting 6m west to E. F is sitting 4m east to G.

12) What is the shortest distance between I and H?

- a. 10m
- b. 15m
- c. 12m
- d. 16m
- e. None of these

13) What is the direction of G with respect to E?

- a. North
- b. South east
- c. North West
- d. South
- e. None of these

14) What is the direction of F with respect to B?

Ultra Practice Bundle PDF for All Bank Prelims Exams

- a. North east
- b. North West
- c. South East
- d. South
- e. None of these

Directions (15-17): Answer the questions based on the information given below.

Anil starts walking in east direction from point A. After walking 5m he turns right from point B and walks for 6m. He then turns left from point C and walks for 4m. He then turns left from point D and walks for 8m till point E. He then turns right and walks for 4m till point F and then turns right. He then walks for 8m till point G and stopped.

15) What is the shortest distance between point D and point G?

- a. 5m
- b. 4m
- c. 6m
- d. 8m
- e. None of these

16) What is the shortest distance between point B and point G?

- a. 10m
- b. 12m
- c. 13m
- d. 15m
- e. None of these

17) What is the direction of C with respect to F?

- a. North
- b. South east
- c. North West
- d. South West
- e. None of these

Directions (18-20): Answer the questions based on the information given below.

Amit starts walking from point R towards west for 5km to reach point T. From point T he took right turn and walks for 8km to reach point Z. From there he again took a right turn and walks 7km to reach point Y. From point Y, Amit took a right turn and walks for 4km to reach point K. After that he took a left turn and walks for 5km to reach point J.

18) Point Y is in which direction with respect to point R?

- a. Southeast
- b. Northeast
- c. Southwest
- d. Northwest
- e. None of these

19) If point G is 4km east of point Z, then how far and in which direction is point K with respect to point G?

- a. Northeast, 5km
- b. Southeast, 2km
- c. Northwest, 4km
- d. Southeast, 5km
- e. East, 6km

20) If another point L, which is 4km south of point K, then which of the following statements regarding point L is true?

- a. Point L is 3km away from point R
- b. Point L is in northeast of point Z
- c. Point L is in south of point Y
- d. Point L is in southwest of point T
- e. All are correct

Directions (21-23): Answer the questions based on the information given below.

Ultra Practice Bundle PDF for All Bank Prelims Exams

Abhishek starts walking from point A in east direction. After walking 10m he turns right and walks for 13m. He then turns left and walks for 5m and then turns left. He walks for 5m and then turns left and walks for 21m and stop at point B.

21) In which direction is point A with respect to point B?

- a. South
- b. North
- c. North-East
- d. North-West
- e. None of these

22) What is the shortest distance between point A and point B?

- a. 15m
- b. 5m
- c. 10m
- d. 9m
- e. None of these

23) What is the total distance covered by Abhishek?

- a. 52m
- b. 54m
- c. 50m
- d. 59m
- e. None of these

Directions (24-25): Answer the questions based on the information given below

Point P is 5m east of point Q, which is 4m north of point R. Point R is exactly between point S and point T. Point S is 4m north of point Q, which is exactly between point U and point P.

24) What is the shortest distance between point U and point T?

- a. 10m
- b. 12m
- c. 16m
- d. 13m
- e. None of these

25) What is the direction of point P with respect to the point T?

- a. North
- b. South west
- c. North east
- d. South east
- e. None of these

Direction (26-27): Answer the following question based on the information given below.

Point A is 8m west of point B. Point E is 1m east of point F. Point G is 2m east of point of H. Point E is 4m north of point D. Point C is 10m west of point D. Point G is 6m north of point F. Point C is 6m south of point B.

26) What is the shortest distance between the point A and point C?

- a. 9m
- b. 13m
- c. 10m
- d. 12m
- e. None of these

27) Point H is in which direction with respect to point B?

- a. North-East
- b. North-West
- c. South-West
- d. South-East
- e. None of these.

Ultra Practice Bundle PDF for All Bank Prelims Exams

Directions (28-30): Answer the questions based on the information given below:

Eight persons, P, Q, R, S, T, U, V and W are sitting at some distance from each other. P is sitting 2m west to Q. V is sitting 9m east to W. S is sitting 5m east to R, who is sitting 3m north to Q. V is sitting 8m north to U. T is 4m west of U. S is 3m north of T.

28) What is the shortest distance between W and the person sitting west to S?

- a. 5m
- b. 2m
- c. 8m
- d. 6m
- e. 3m

29) What is the direction of R with respect to V?

- a. South
- b. South east
- c. North east
- d. South west
- e. None of the above

30) What is the total distance between P and U?

- a. 15m
- b. 12m
- c. 18m
- d. 11m
- e. 13m

Directions (31-32): Answer the questions based on the information given below:

Point R is 4m north of point P. Point S is 9m north of point Q. Point U is 3m north of point S, which is 6m east of point R. Point Q is 5m west of point T.

31) What is the shortest distance between point U and point T?

- a. 13m
- b. 17m
- c. 15m
- d. 12m
- e. None of these

32) What is the direction of point Q with respect to point R?

- a. North east
- b. South west
- c. South east
- d. East
- e. None of these

Directions (33-35): Answer the questions based on the information given below:

Seven persons, A, B, C, D, E, F and G are sitting at some distance from each other. D is sitting 3m north to F, who is sitting 4m west to G. C is sitting 4m west to B. E is sitting 4m west to D. A is sitting 9m south to C. B is sitting 3m south to E.

33) What is the direction of E with respect to A?

- a. North
- b. North east
- c. North West
- d. South west
- e. None of these

34) What is the shortest distance between G and A?

- a. 15m
- b. 10m
- c. 12m
- d. 8m
- e. None of these

35) What is the shortest distance between C and E?

- a. 5m

Ultra Practice Bundle PDF for All Bank Prelims Exams

- b. 10m
- c. 12m
- d. 8m
- e. None of these

Directions (36-38): Answer the questions based on the information given below.

Vani walks 8m from point R towards the east to reach point S. Then she turns left and walks 10m to reach the point T. Then she moves 12m east direction and reach the stationary shop. Then she moves 10m in south direction and then turns left and walks 4m to stop at point D. Karan walks 10m from point B towards the east direction and then he turns left and walks 5m to stop at point D.

36) What is the distance between Karan's ending point and Vani's starting point?

- a. 24m
- b. 20m
- c. 10m
- d. 23m
- e. None of these

37) Point B is in which direction with respect to point T?

- a. South west
- b. South
- c. South east
- d. North west
- e. None of these

38) Stationary shop is in which direction with respect to point R?

- a. South west
- b. North East
- c. South east
- d. North west

- e. None of these

Direction (39-41): Study the information given below carefully and answer the questions that follow.

Point A is 4m west of point G, which is 8m north of point B. Point E is 11m south of point D, which is 7m east of point F. Point H is 10 south of point C, which is 5m north of point F. Point B is 6m west of point H.

39) Which among the following statements is/are true?

- a. Shortest distance between point G and point H is equal to the distance between point H and point C.
- b. Shortest distance between point B and point D is less than the distance between point D and point E.
- c. Point A is north east of point H.
- d. Both (a) and (c)
- e. None is true.

40) What is the shortest distance between point G and the point H?

- a. 14m
- b. 12m
- c. 10m
- d. 11m
- e. None of these

41) In which direction is C with respect to D?

- a. East
- b. North - West
- c. North - east
- d. South
- e. None of these

Directions (42-44): Answer the questions based on the information given below.

Six persons, P, Q, R, S, T and U are sitting at some distance from each other. P is sitting 5m west to T. R is

Ultra Practice Bundle PDF for All Bank Prelims Exams

sitting 7m north to U, who is sitting 4m east to S. T is sitting 3m north to Q, who is sitting 2m east to S.

42) What is the direction of P with respect to U?

- a. North
- b. South east
- c. North east
- d. North West
- e. None of these

43) What is the shortest distance between S and the person sitting in the 2m east of T?

- a. 5m
- b. 3m
- c. 6m
- d. 10m
- e. None of these

44) What is the total distance between S and R if we move in straight lines?

- a. 15m
- b. 13m
- c. 16m
- d. 11m
- e. None of these.

Directions (45-47): Answer the questions based on the information given below.

Point S is 5m east of point K, which is 4m south of point P. Point R is 6m south of point S, which is the middle point of point A and point R. Point L is 5m east of point A. Point L is 14m east of point N. Point A is in north of R.

45) What is the shortest distance between point R and the point, which is 2m north of point P?

- a. 14m
- b. 17m
- c. 12m

d. 13m

e. None of these

46) What is the direction of point N with respect to point K?

- a. North east
- b. South west
- c. South east
- d. North west
- e. None of these

47) What is the direction of point K with respect to point L?

- a. North east
- b. South east
- c. South west
- d. North west
- e. None of these

Directions (48-50): Answer the questions based on the information given below.

A person starts walking from point P in east direction. After walking 3m he turns right from point Q and walks for 4m he turns left from point R. He then walks for 2m and then turns left from point S. He walks for 8m and turns right from point T. He walks for 3m and turns right from point U and walks for 10m. He then turns right from point V and walks for 8m till point W.

48) What is the shortest distance between P and R?

- a. 3m
- b. 6m
- c. 5m
- d. 4m
- e. None of these

49) In which direction is point T with respect to point V?

Ultra Practice Bundle PDF for All Bank Prelims Exams

- a. West
- b. North-West
- c. East
- d. North
- e. South

- a. North
- b. North-West
- c. North-East
- d. South-West
- e. None of these

50) In which direction is point P with respect to point W?

Answers with Explanation

- 1. d
- 2. b
- 3. c

Solutions 1-3

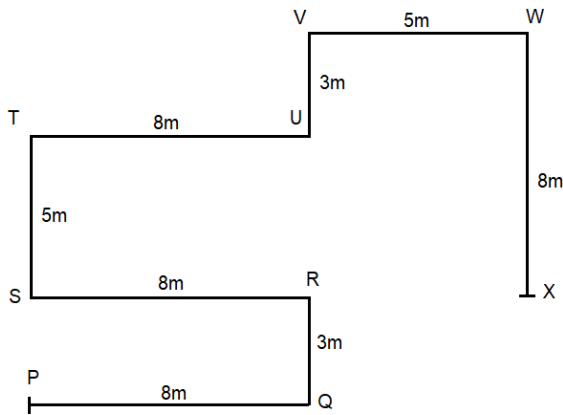

Answers

- 4. e
- 5. b
- 6. c

Solutions 4-6

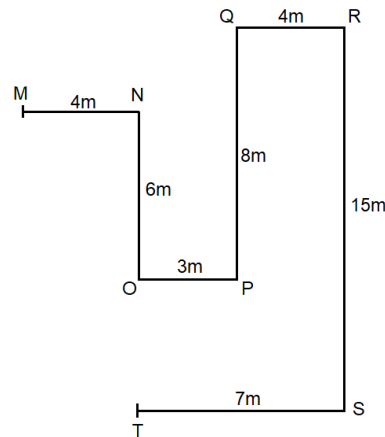

Answers

- 7. b
- 8. a

Solutions 7-8



Ultra Practice Bundle PDF for All Bank Prelims Exams

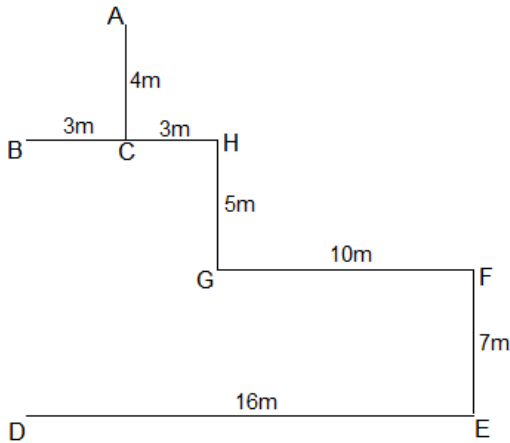

Answers

- 9. c
- 10. c
- 11. b

Solutions 9-11

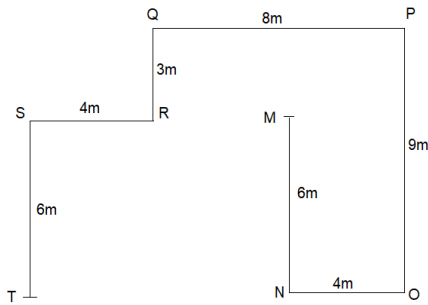

Answers

- 12. a
- 13. c
- 14. a

Solutions 12-14

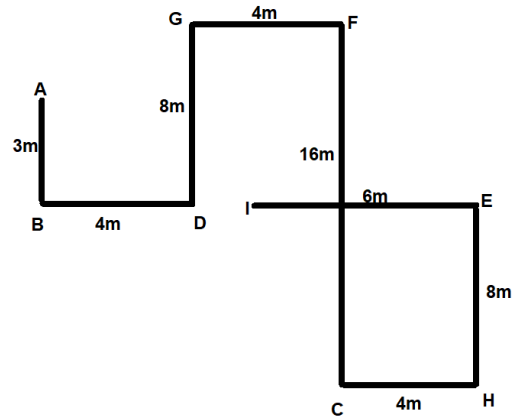

Answers

- 15. b
- 16. a
- 17. d

Solutions 15-17

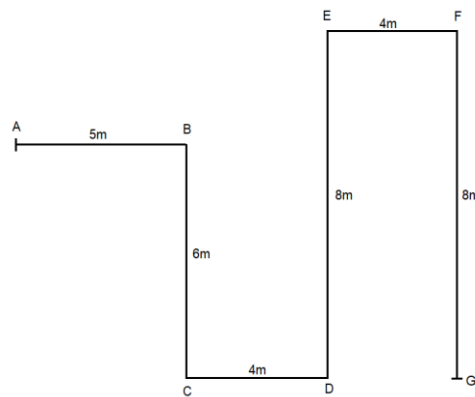

Answers

- 18. b
- 19. d
- 20. c

Solutions 18-20



Ultra Practice Bundle PDF for All Bank Prelims Exams

Amit starts walking from point R towards west for 5km to reach point T.

From point T he took right turn and walks for 8km to reach point Z. From there he again took a right turn and walks 7km to reach point Y.

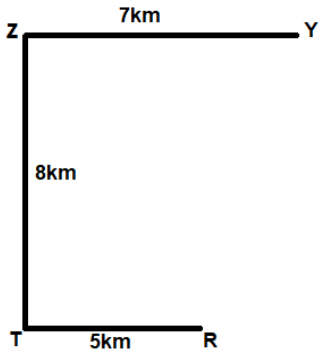

From point Y, Amit took a right turn and walks for 4km to reach point K. After that he took a left turn and walks for 5km to reach point J.

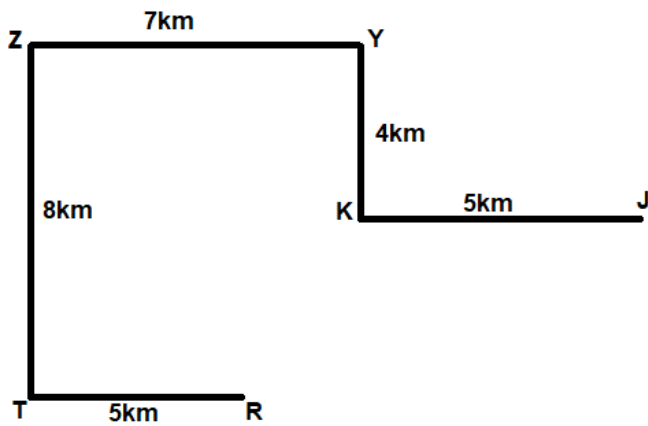

Answers

- 21. c
- 22. c
- 23. b

Solutions 21-23

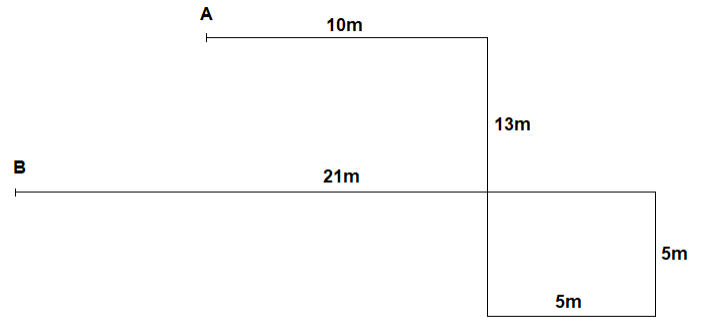

Answers

- 24. d
- 25. c

Solutions 24-25

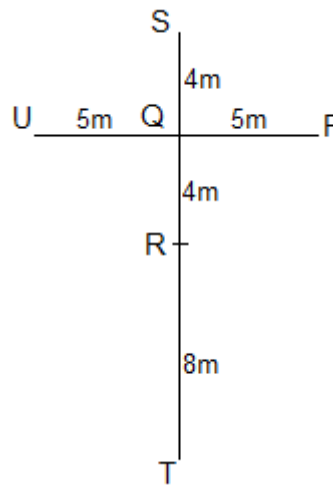

Answers

- 26. c
- 27. a

Solutions 26-27



Ultra Practice Bundle PDF for All Bank Prelims Exams

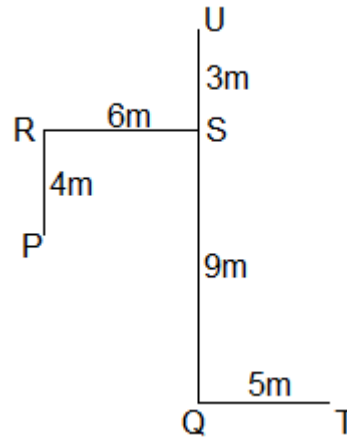
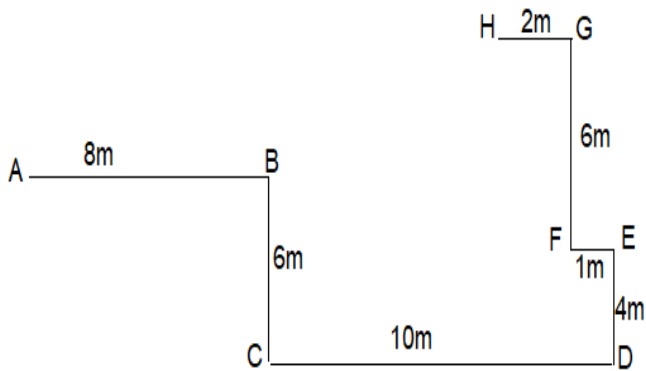

Answers

- 28. a
- 29. d
- 30. d

Solutions 28-30

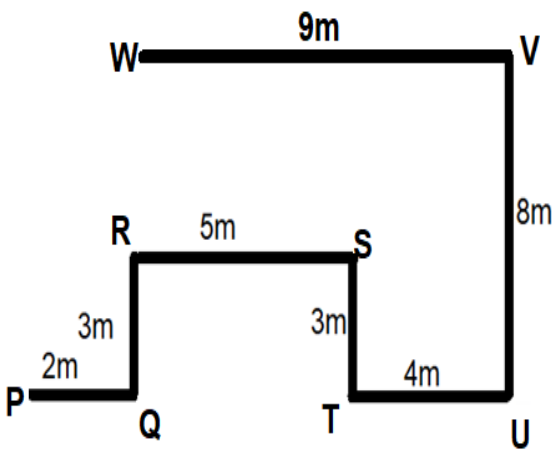

Answers

- 31. a
- 32. c

Solutions 31-32

Answers

- 33. b
- 34. a
- 35. a

Solutions 33-35

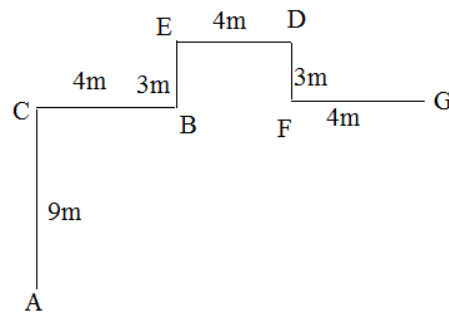

Answers

- 36. a
- 37. c
- 38. b

Solutions 36-38



Ultra Practice Bundle PDF for All Bank Prelims Exams

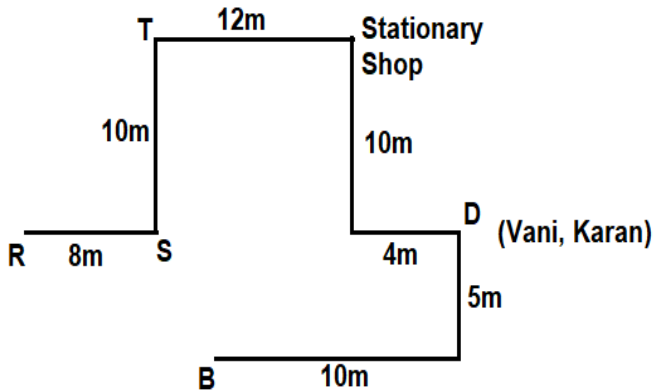

Answers

39. a

40. c

41. b

Solutions 39-41

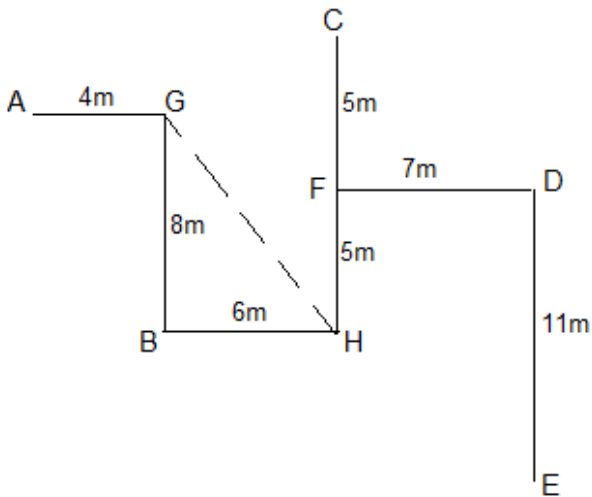

Answers

42. d

43. a

44. d

Solutions 42-44

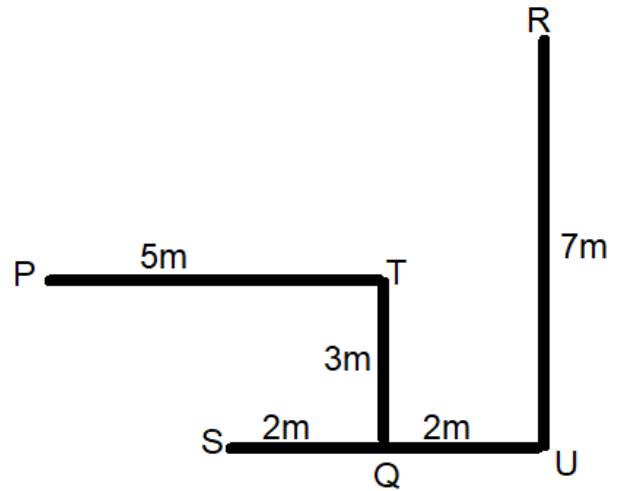

Answers

45. d

46. d

47. c

Solutions 45-47

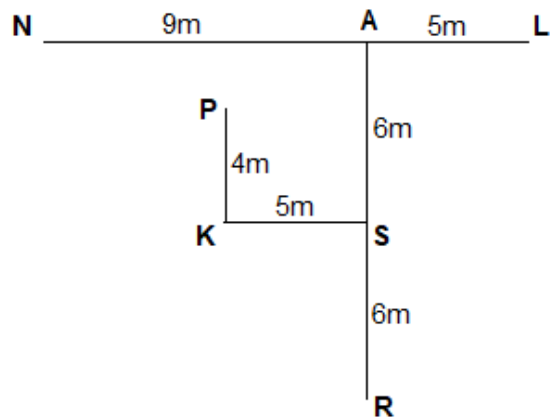

Answers

48. c

49. b

50. a

Solutions 48-50

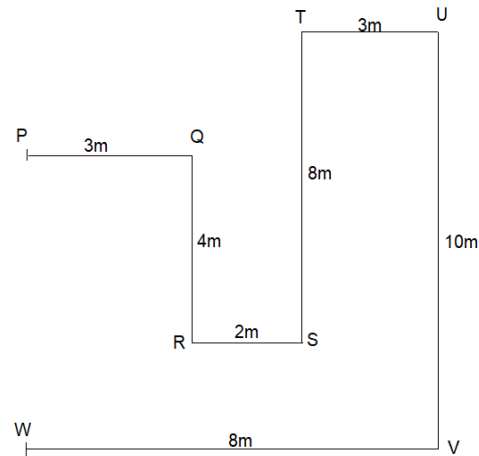

13. Alphanumeric Series

Directions (1-5): Study the following sequence carefully and answer the questions given below it.

L < X % V 9 7 8 B @ > B 6 N # ? P /
S ^ T U 5 I \$ © 4 D F ↑

1. Find the next group in the following series.

9 B @, B # ?, / T U, _____

- A) I 4 D
- B) T I \$
- C) 4 D F
- D) U 5 I
- E) None of These

2. Four of the following are alike in a particular pattern and hence form a group. Find the one which does not follow the pattern?

- A) X % <
- B) 9 7 8
- C) @ > B
- D) N # 6
- E) # ? N

3. How many numbers are there in the sequence which is immediately followed by a letter?

- A) One
- B) Two
- C) Four
- D) Three
- E) More than four

4. Which of the following is the 19th element to the right of the 7th element to the left of the 10th element from the left end when first 20 elements reversed?

- A) U
- B) 5
- C) I
- D) T
- E) None of These

5. How many symbols are there, each of which are immediately followed by a consonant and preceded by a vowel?

- A) One
- B) Two
- C) Three
- D) Four
- E) None

Ultra Practice Bundle PDF for All Bank Prelims Exams

Directions (6-8): Study the following alphabet series and answer the questions given below.

L # V 3 / N W + 6 J Y K ↑ @ S T 8 C 2 ↓ F 9 E > 4 H %
G * &

6. How many such symbols are there in the above sequence, which are immediately followed by a consonant and immediately preceded by a number?

- A) Three
- B) Two
- C) Four
- D) One
- E) None of These

7. Which is the 14th element to the right of 13th element from the left end?

- A) H
- B) 4
- C) G
- D) %
- E) 8

8. Find the next element in the following series.

L, V, N, J, S, _____

- A) E
- B) H
- C) F
- D) G
- E) None of These

Direction (9-13): Study the following arrangement and answer the given questions:

A / X V 4 D @ L # B H 9 & X 2 B K % R 3 5 R J O 7 M
^ A 6

9. If all the symbols are dropped from the above arrangement, which of the following will be the sixth from the right end?

- A) M
- B) A
- C) 6

- D) R
- E) J

10. How many such vowels are there in above arrangement, each of which is immediately preceded by a consonant and immediately followed by a number?

- A) None
- B) Three
- C) Two
- D) One
- E) None of These

11. How many such numbers are there in above arrangement, each of which is immediately preceded and also immediately followed by consonant?

- A) One
- B) Three
- C) Two
- D) None
- E) None of These

12. Which of the following will be the fourth to the left of the seventeenth from the left end of the above arrangement?

- A) 9
- B) &
- C) X
- D) 2
- E) None of These

13. Which of the following is the fourth to the right of the eleventh to the right of first X in the given arrangement?

- A) %
- B) K
- C) B
- D) R
- E) None of These

Directions (14-15): Study the following information carefully to answer the questions given below.

Ultra Practice Bundle PDF for All Bank Prelims Exams

S N B 5 P % E 7 C 4 # G I \$ 2 D G * 1 8 L 3 V @ 9 Z X & Y

14. How many such consonants are there in the above arrangement, each of which is immediately followed by a number but not immediately preceded by a vowel?

- A) None
- B) One
- C) Two
- D) Four
- E) Three

15. Which of the following is the 5th to the left of the 20th from the left end in the above arrangement?

- A) \$
- B) I
- C) D
- D) 2
- E) G

Directions (16-20): Study the following letters/numbers/symbols sequence and answer the following questions.

C 4 & 3 A B G 9 # @ 2 Q N S% 5 1 J
D * 0 L V 7 L ! C \$ K V 6 I

16. How many numbers are there in the series, which are immediately preceded by a letter and immediately followed by a consonant?

- A) None
- B) Two
- C) Three
- D) More than three
- E) One

17. If all the numbers are dropped from the series, which element will be 5th to the left of 15th from left end?

- A) Q
- B) S

- C) %
- D) N
- E) None of These

18. Which of the following is 8th to the right of 15th from right end of row?

- A) L
- B) C
- C) !
- D) \$
- E) K

19. Four of the following are alike in a certain way, so form a group. Find the odd one out – the one which does not belong to that group.

- A) C 4 &
- B) @ Q S
- C) 5 1 J
- D) D * 0
- E) V 7 L

20. The following series follow a certain pattern. What will come in question mark (?) in the series: 43B, 9@Q, S5j, *L7, ?

- A) LCK
- B) 0LV
- C) V7L
- D) !\$V
- E) None of These

Directions (21-25): Study the following letters/numbers/symbols sequence and answer the following questions.

8 1 @ L M C # 7 * E G 6 V B 3 S 5 \$ N 8 % ◇ P D 1 P 4
Y X Z

21. How many numbers are there in the series, which immediately preceded by a symbols and immediately followed by a letter?

- A) One
- B) Two

Ultra Practice Bundle PDF for All Bank Prelims Exams

- C) Three
- D) More Than Three
- E) None

22. If all the numbers are dropped from the series, which element will be 5th to the left of 18th from left end?

- A) \$
- B) 8
- C) %
- D) N
- E) None of These

23. Which of the following will be second to the right of 17th from the left end?

- A) \$
- B) 5
- C) N
- D) 8
- E) %

24. If every second element from the left end dropped from the series, which element is 4th to left of 11th from the right end in new arrangement?

- A) 8
- B) 1
- C) @
- D) L
- E) None of These

25. What is the total number of 'The numbers immediately follow the letters' and 'The symbols immediately followed by a consonant' together in the above sequence?

- A) Nine
- B) Seven
- C) Six
- D) Five
- E) Four

Directions (26-30): Study the following arrangement and answer questions given:

E M @ 3 2 * V D % ! A N Q (B X ~ 9 C + T Y # L Z 6

26. If the first fifteen elements in the above passage sequence are written in reverse order then which of the following will be seventeenth from the right end?

- A) V
- B) 2
- C) D
- D) %
- E) *

27. If the above sequence is written in reverse order then which of the following will be fifth to the right of twelve element from the right end?

- A) D
- B) *
- C) 2
- D) V
- E) 3

28. What should come in place of question mark in the following on the basis of the above sequence?

6#T, CX(, ?

- A) NA1
- B) N%V
- C) DV*
- D) Cannot Be Determined
- E) None of These

29. How many such symbols are there in the above sequence, each of which is immediately preceded by a consonant and immediately followed by a number?

- A) One
- B) Two
- C) Three
- D) More Than Three
- E) None of These

30. Which of the following is sixth to the left of fourteenth element from the left end?

- A) D

Ultra Practice Bundle PDF for All Bank Prelims Exams

- B) V
- C) %
- D) *
- E) None of These

Directions (31-35): Study the following arrangement and answer questions given:

8 2 Z * # C D 9 N 0 1 & ~ M A) 6 R B Y 3 J + < = F K

31. Which of the following is the 4th element to the left of the 14th element from the right end?

- A) 1
- B) &
- C) M
- D) A
- E) 0

32. How many such numbers are there in the above arrangement each of which is immediately preceded by a consonant and immediately followed by a symbol?

- A) One
- B) Two
- C) Three
- D) None
- E) More Than Three

33. Which of the following is the 6th letter to the left of the 14th letter from the left end?

- A) D
- B) N
- C) 9
- D) M
- E) A

34. How many such numbers are there each of which is immediately preceded by a consonant?

- A) Two
- B) Three
- C) One
- D) More Than Three

- E) None of These

35. Four of the five are alike in a certain way based on arrangement, which does not belong to the group?

- A) Z # D
- B) N 0 1
- C) 6 R B
- D) R B Y
- E) None of These

Directions (36-40): Study the following arrangement and answer questions given:

T % # C D Z 3 @ 0 N ! K 6 * A H V 8 ^ Y & Q 7 O J 1 2 \$ C B)

36. Which of the following is the 7th element to the right of the 12th letter from the right end?

- A) \$
- B) C
- C) B
- D) J
- E) 2

37. How many such numbers are there in the above arrangement each of which is immediately preceded by a consonant and immediately followed by a symbol?

- A) One
- B) Two
- C) Four
- D) Three
- E) None of These

38. Which of the following is the 7th element to the left of the 20th element from the left end?

- A) 5
- B) 4
- C) 6
- D) 3
- E) None of These

Ultra Practice Bundle PDF for All Bank Prelims Exams

39. How many such symbols are there each of which is immediately preceded by a vowel?

- A) One
- B) None
- C) Two
- D) Three
- E) None of These

40. Four of the five are alike in a certain way based on arrangement, which does not belong to the group?

- A) CD3
- B) T%#
- C) 0N!
- D) AHV
- E) Y&Q

Directions (41-45): Study the following arrangement and answer questions given:

(C D ~ 6 2 % S Z 8 Y) * 1 K N 9 @ V X \$ 3 ^ R 4 A S #

41. How many such vowels are there in the above arrangement, each of which is immediately followed by a letter and not preceded by a symbol?

- A) None
- B) Two
- C) Three
- D) More Than Three
- E) One

42. What is the sum of all numbers which are immediately followed by a letter?

- A) 18
- B) 19
- C) 20
- D) 21
- E) 22

43. What will come in place of questions mark (?) based on the above arrangement?

CD~, %SZ,)*1, ?

- A) KN9
- B) R4A
- C) 9@V
- D) X\$3
- E) None of These

44. Four of the following five are alike in a certain way based on their positions in the above arrangement and so form a group. Which is the one that does not belong to that group?

- A) % 8 *
- B) C ~ 2
- C) 1 9 X
- D) \$ R S
- E) None of These

45. Which of the following is the 7th to the left of the 20th from the left end of the above arrangement?

- A) *
- B))
- C) 1
- D) K
- E) N

Directions (46-50): Study the following arrangement and answer questions given:

L G 2 ^ I ! A R 3 D 7 \$ 9 K # C E 8 Z I % M R 4 U * N + W

46. How many such numbers are there in the above arrangement, each of which is immediately preceded by a symbol and immediately followed by a vowel?

- A) One
- B) Two
- C) Three
- D) More Than Three
- E) None

47. How many such consonants are there in the above arrangement, each of which is immediately preceded by a number and immediately followed by a letter?

Ultra Practice Bundle PDF for All Bank Prelims Exams

- A) Two
 B) Three
 C) More Than Three
 D) One
 E) None of These

48. Which of the following is the 6th to the right of the 20th from the right end of the above arrangement?

- A) #
 B) E
 C) C
 D) 8
 E) X

49. Four of the following five are alike in a certain way based on their positions in the above

arrangement and so form a group. Which is the one that does not belong to that group?

- A) L2I
 B) AR3
 C) D\$K
 D) C8I
 E) IM4

50. Which of the following is the 5th to the left of the 13th from the right end of the above arrangement?

- A) \$
 B) 9
 C) K
 D) 7
 E) None of These

Detailed Explanation with Answers:

Answers (1-5): The series given in this question is:

L < X % V 9 7 8 B @ > B 6 N # ? P / S
 ^ T U 5 I \$ © 4 D F ↑

- 1) A
 2) B
 3) C
 4) A
 5) E

Solutions (1-5):

1) We will look at the first element and the second element then we came to know that after first element two elements are left and then third element is taken and when we will look for the relation between second and the third element third element is immediate next to the second element.

When next series is taken it starts with the same pattern but after leaving one element between the last element of the first series and first element of the next series.

As per this pattern the series which will come in place of the blank will be **I4D**.

Answer: A (I4D)

2) In this question we will take one option at a time and look for the pattern.

In first option, first element is between the second and third element in the series given.

In second option, second element is immediate next to the first element and third element is immediate next to the second element.

In third option, first element is between the second and third element in the series given.

In fourth and fifth option, first element is between the second and third element in the series given.

As per the pattern only option is the second one which does not follow this pattern, so answer will be **9 7 8**.

Answer: B (9 7 8)

3) We will look for such numbers in the series which is being followed by a letter.

Here, in the series we found four such pairs and the pairs are: **8B, 6N, 5I and 4D**. So answer will be four such pairs

Answer: C (Four)

Ultra Practice Bundle PDF for All Bank Prelims Exams

4) After reversing the first 20 elements in this question the new series will look like this:

^ S / P ? # N 6 B > @ B 8 7 9 V % X < L T U 5 I \$ © 4 D F
↑

Tenth element from the left end in the new series will be > and 7th element to the left of this > is / and the 19th element to the right of / will be U.

Answer: **A (U)**

5) In this question we will look for such symbols which are immediately followed by a consonant and preceded by a vowel.

There are no such pair in the series given, so answer will be **NONE**

Answer: **E (None)**

Answers (6-8): The series given in this question is:

L # V 3 / N W + 6 J Y K ↑ @ S T 8 C 2 ↓ F 9 E > 4 H % G
* &

6) **B**

7) **D**

8) **C**

Solutions (6-8):

6) In this question we will have to look for such symbols which are immediately followed by a consonant and immediately preceded by a digit.

As per this pattern there are two such pairs and they are: 3/N and 2↓F. So, answer is **Two**

Answer: **B (Two)**

7) In this question we have to find 14th element to the right of 13th element from the left end.

The element which is 13th from the left end is ↑ and the element which is 14th to the right of this element is %

Answer: **D (%)**

8) In this question we have to first identify the pattern

The pattern is after first element that is L one element is left and the next element is written that is V and after V two

elements are left and the third element is written that is N and after N three elements are left and next element is written that is J and after J four elements are left and fifth elements is written that is S. Now as we can see each time one element which is being left is added to the number of left elements, so after S five elements will be left and the next element will be F

Answer: **C (F)**

Answers (9-13): The series given in this question is:

A / X V 4 D @ L # B H 9 & X 2 B K % R 3 5 R J O 7 M ^
A 6

9) **E**

10) **D**

11) **C**

12) **B**

13) **A**

Solutions (9-13):

9) In this question we will drop all the symbols from the series and the new series will look like this:

A X V 4 D L B H 9 X 2 B K R 3 5 R J O 7 M A 6

Now in the above series we have to find the sixth element from the right end and that element is J

Answer: **E (J)**

10) In this question we have to find and look for such vowels which is immediately preceded by a consonant and immediately followed by a number

Now there is only one such pair and that pair is JO7

Answer: **D (One)**

11) In this question we have to find and look for such numbers which is immediately preceded and also immediately followed by consonant.

As per this pattern we find there are two such pairs and they are: V4D and X2B. SO, answer is **Two**

Answer: **C (Two)**

Ultra Practice Bundle PDF for All Bank Prelims Exams

12) In the series given in the question we have to find the element which is fourth to the left of the seventeenth from the left end.

Element which is seventeenth from the left end is **K** and the element which fourth to the left of this element is **&**
Answer: B (&)

13) In this question we have to look for that element which is fourth to the right of the eleventh to the right of first X in the series given in the question.

Element which is eleventh to the right of first X is **X** and the element fourth to the right of **X** will be **%**
Answer: A (%)

Answers (14-15): The series given in this question is:

S N B 5 P % E 7 C 4 # G I \$ 2 D G * 1 8 L 3 V @ 9 Z X & Y

14) **E**

15) **D**

Solutions (14-15):

14) In this question we have to find such consonants, which is immediately followed by a number but not immediately preceded by a vowel

As per this pattern there are only 3 pairs and such pairs are:

B5, C4 and L3. So, answer is **Three**

Answer: E (Three)

15) In this question we have to find the element which 5th to the left of the 20th from the left end.

Element which is 20th from the left end is **8** and the element which is 5th to the left of this element is **2**. So, answer will be **2**

Answer: D (2)

Answers (16-20): The series given in this question is:

C 4 & 3 A B G 9 # @ 2 Q N S % 5 1 J D * 0 L V 7 L ! C \$ K V 6 I

16) **E**

17) **B**

18) **C**

19) **B**

20) **D**

Solutions (16-20):

16) In this question we have to find such numbers which are immediately preceded by a letter and immediately followed by a consonant.

Now, as per this pattern there is only one such pair and that pair is: **V7L**. So, answer will be **One**

Answer: E (One)

17) In this question we will drop all the numbers and the new series will look like this:

C & A B G # @ Q N S % J D * 0 L V L ! C \$ K V I

Now in the new series the element which is 15th from the left end will be **O** and the element which is 5th from the left of this element will be **S**. So answer will be **S**

Answer: B (S)

18) In this question we have to look for element which is 8th to the right of 15th from right end of row.

The element which is 15 from the right end of the row will be **J** and the element which is to the right of this element will be **!**

Answer: C (!)

19) In this question we will take option one by one and try to find the pattern.

In the first option, the pattern is second element is the next element to the first element and third element is immediate next to the second element.

In the second option, the pattern is one element is left after the element and the next element is written and after second element one element is left and the next element is written

In the third, fourth and fifth option, the pattern is second element is the next element to the first element and third element is immediate next to the second element.

So, answer will be **@ Q S**

Answer: B (@ Q S)

Ultra Practice Bundle PDF for All Bank Prelims Exams

20) In this question we will try to find the pattern of the series. The pattern is one element is left after the first element and the next element is written and after second element one element is left and the next element is written and between the first element series and second element series one element is left. As per this pattern the pair which will come will be: **!\$V**
 Answer: **D (!\$V)**

Answers (21-25): The series given in this question is:

8 1 @ L M C # 7 * E G 6 V B 3 S 5 \$ N 8 % ◇ P D 1 P 4 Y X Z

- 21) E
- 22) D
- 23) C
- 24) A
- 25) A

Solutions (21-25):

21) In this question we have to find such numbers which immediately preceded by a symbols and immediately followed by a letter.
 Now as per this pattern there are no such pairs which show the above mentioned pattern.
 Answer: **E (None)**

22) In this we will drop all the numbers and the new series will look like this:

@ L M C # * E G V B S \$ N % ◇ P D P Y X Z

Now as per the above series we will find out the 18th element from the left end and that element is **P** and the element which is 5th to the left of this element will be **\$**. So, answer will be **N**
 Answer: **D (N)**

23) Now in this question we have look for that element which second to the right of 17th from the left end.
 Element which is 17th from the right end is **5** and the element which second from this element is **N**. So answer will be **N**
 Answer: **C (N)**

24) In this question we will drop every second element from the left end and the new series will look like this:

8 @ M # * G V 3 5 N % P 1 4 X

As per the above series the element which is 11th from the right end is ***** and the element which is 4th to this element is **8**
 Answer: **A (8)**

25) In this question we will find the numbers immediately following the letters and the symbols immediately followed by a letter

Pairs of the numbers immediately following the letters: **G6, B3, S5, N8, D1** and **P4**

Pairs of the symbols immediately followed by a letter: **@L, \$N** and **◇P**

Answer: **A (Nine)**

Answers (26-30): The series given in this question is:

E M @ 3 2 * V D % ! A N Q (B X ~ 9 C + T Y # L Z 6

- 26) E
- 27) D
- 28) B
- 29) B
- 30) A

Solutions (26-30):

26) In this question we will write the first 15 elements in the reverse order and the new series will look like this:

B (Q N A ! % D V * 2 3 @ M E X ~ 9 C + T Y # L Z 6

Now we have to find the element which 17th from the right end and that element is *****. So, answer is *****
 Answer: **E (*)**

27) In this question we have to write the above series in the reverse order and the new series will look like this:

6 Z L # Y T + C 9 ~ X B (Q N A ! % D V * 2 3 @ M E

Now in this question we have to find the element which 12th from the right end and that element is **N** and the element which is 5th to the right of this element is **V**. So answer is **V**
 Answer: **D (V)**

Ultra Practice Bundle PDF for All Bank Prelims Exams

28) In this question we have to look for the pattern which is being followed in the series

The pattern after first element two elements are left and the next element is written and then after that element one element is left and the next element is written. Between the two pairs there is a gap of one element.

As per this pattern the pair which will come in place of question mark will be: **N%V**

Answer: **B (N%V)**

29) In this question we will look for such symbols which is immediately preceded by a consonant and immediately followed by a number.

Now the pair which follows this pattern is: **M@3** and **X ~ 9**.

So, answer is **Two**

Answer: **B (Two)**

30) In this question we have to find out element which is sixth to the left of fourteenth element from the left end.

Element which is 14th from the left end is (and the element which is 6th to the left of this element is **D**

Answer: **A (D)**

Answers (31-35): The series given in this question is:

8 2 Z * # C D 9 N 0 1 & ~ M A) 6 R B Y 3 J + < = F K

31) E

32) D

33) C

34) B

35) A

Solutions (31-35):

31) In this question we have to find 4th letter to the left of the 14th letter from the right end.

The element which is 14th from the right end is **M** and the element which is 4th to the left of this element is **0**.

Answer: **E (0)**

32) In this question we have to find such numbers which is immediately preceded by a consonant and immediately followed by a symbol.

There is no such pair which follows such pattern. So, answer is **NONE**

Answer: **D (None)**

33) In this question we have to find the element which is 6th letter to the left of the 14th letter from the left end.

The element which is 14th from the left end is **M** and the element which is 6th from the left of this element is **9**

Answer: **C (9)**

34) In this question we have to look for such numbers which is immediately preceded by a consonant.

There are three such pairs which follows this pattern and they are: **D9**, **N0** and **Y3**.

Answer: **B (Three)**

35) In this question we have to find common pattern between all the options and the option which does not follows that pattern will be our answer.

In the first option after first element one element is left and then the next element is written and after second element one element is left and the next element is written

In the second option, second element is immediate next to the first element and the third element is immediate next to the second element.

In the third and fourth option, second element is immediate next to the first element and the third element is immediate next to the second element.

So, answer will first option

Answer: **A (Z#D)**

Answers (36-40): The series given in this question:

T % # C D Z 3 @ 0 N ! K 6 * A H V 8 ^ Y & Q 7 O J 1 2 \$ C B)

36) E

37) D

38) C

39) B

40) A

Solutions (36-40):

36) In this question we have to find the element which is 7th element to the right of the 12th letter from the right end.

Ultra Practice Bundle PDF for All Bank Prelims Exams

Element which is 12th from the right end is **Y** and the element which is 7th to the right of this element is **2**

Answer: **E (2)**

37) In this question we have to look for such numbers which is immediately preceded by a consonant and immediately followed by a symbol

There are three such pairs which follows this pattern and they are: **Z3@**, **K6*** and **V8^**. So answer is **Three**

Answer: **D (Three)**

38) In this question we have to find out the element which is 7th to the left of 20th element from the left end.

Element which is 20th from the left end is **Y** and the element which is 7th to the left of this element is **6**

Answer: **C (6)**

39) In this question we have to find out such symbols which is immediately preceded by a vowel.

There are no such pairs which follows the above-mentioned pattern. So answer is **NONE**

Answer: **B (None)**

40) In this question we have to find a common pattern among the four options and the option which does not follows this patten will be our answer.

In the first option second element is immediate next of the first element and there is a gap of one element between the second and the third element.

In the second option, there is no gap between all the three elements means they are the immediate next of each other.

In the third, fourth and fifth option, there is no gap between all the three elements means they are the immediate next of each other.

So, answer will first option

Answer: **A (CD3)**

Answers (41-45): The series given in this question is:

(C D ~ 6 2 % S Z 8 Y) * 1 K N 9 @ V X \$ 3 ^ R 4 A S #

41) E

42) D

43) C

44) B

45) A

Solutions (41-45):

41) In this question we have to find out such vowels, which is immediately followed by a letter and not preceded by a symbol.

As per the above mentioned pattern there is only such pair which follows this pattern and that pair is: **AS**

Answer: **E (One)**

42) In this question we have to look for such numbers which is immediately preceded by a letter and we have to find the sum of such numbers.

There are three such pairs which follows the above mentioned pattern and they are: **Z8**, **N9** and **R4**. And the sum of such numbers means we have to add $8+9+4=21$

Answer: **D (21)**

43) In this question we have to find the pattern which is being followed by the series which is being asked in the question.

The pattern is: The elements are immediate next of each other and there is a gap of two elements between two such pairs, so the next pair which will come in place of question mark will be: **9@V**

Answer: **C (9@V)**

44) In this question we have to find a common pattern among the four options and the option which does not follows this patten will be our answer.

In the first option there is a gap of two elements between elements of this pair

In the second option, there is a gap of one element between elements of this pair

In the third and fourth option, there is a gap of two elements between elements of those pairs

So, answer will be second option

Answer: **B (C ~ 2)**

45) In this question we have to look for that element which is 7th to the left of the 20th from the left end

The element which is 20th from the left end is **X** and the element which 7th to the left of this element is *

Answer: **A (*)**

Answers (46-50): The series given in this question is:

Ultra Practice Bundle PDF for All Bank Prelims Exams

L G 2 ^ I ! A R 3 D 7 \$ 9 K # C E 8 Z I % M R 4 U * N +
W

- 46) E
- 47) D
- 48) C
- 49) B
- 50) A

Solutions (46-50):

46) In this question we have to find such numbers which is immediately preceded by a symbol and immediately followed by a vowel

There are no such pairs which follows the above mentioned pattern. So, answer will be **NONE**

Answer: **E (None)**

47) In this question we have to find such consonants which is immediately preceded by a number and immediately followed by a letter

There is only one such pair which follows this above mentioned pattern and that pair is: **8ZI**

Answer: **D (One)**

48) In this question we have to find that element which is 6th to the right of the 20th from the right end.

The element which is 20th from the right end is **D** and the element which is 6th to the right of this element is **C**

Answer: **C (C)**

49) In this question we have to find a common pattern among the four options and the option which does not follows this patten will be our answer.

In the first option, there is a gap of one element between elements of this pair

In the second option, there is no gap between the elements of this pair

In the third, fourth and fifth option, there is a gap of one element between elements of these pairs

So, answer will be second option

Answer: **B (AR3)**

50) In this question, we have to find that element which is 5th to the left of the 13th from the right end

The element which is 13th from the right end is **E** and the element which is 5th to the left of this element is **\$**

Answer: **A (\$)**

14.Data Sufficiency

Directions (1-5): Each of the questions given below consists of a question and two statements numbered I and II given below it. You have to decide whether the data provided in the statements are sufficient to answer the question or not. Read both the statements and answer the question.

a) If the data in statement I alone is sufficient to answer the question, while the data in statement II alone is not sufficient to answer the question.

b) If the data in statement II alone is sufficient to answer the question, while the data in statement I alone is not sufficient to answer the question.

c) If the data either in statement I alone or in statement II alone are sufficient to answer the question.

d) If the data in both statement I and II together are not sufficient to answer the question.

e) If the data in both statement I and II together are necessary to answer the question.

1) Among A, B, C, D and E sitting around a circular table facing the centre, who sits second to the right of C?

I. C sits to the immediate right of A. Only two persons were sitting between B and A.

Ultra Practice Bundle PDF for All Bank Prelims Exams

II. Both D and C are immediate neighbours of B. E sits second to the right of B.

2) Amongst five bags L, M, N, O and P, each having a different weight. Which of the bag is heaviest?

I. Only two bags are heavier than O. O is heavier than P but lighter than M.

II. N is lighter than O but heavier than P. L is heavier than O, but not the heaviest.

3) How many students are there in class 10 in the school X?

I. The class teacher of class 10 correctly remembers that the number of students in her class is more than 21 but less than 32. The number of students in the class is exactly divisible by 6.

II. The principal of the school correctly remembers that the difference between the students in class 10 and class 7 is less than nine. There are 33 students in class 7.

4) Six persons A, B, C, D, E and F are living on different floors of a building in such a way that the ground floor is numbered as 1, the above 1 is numbered as 2 and so on till the topmost floor is numbered as 6. How many persons are living between A and D?

I. C lives on an even numbered floor but not on the topmost floor. Only two persons were living between F and C. A lives below F.

II. Only four persons living between B and D. No one lives between the floors on which B and C lives. F lives immediately below D.

5) Six persons J, K, L, M, N and O sitting in a row facing north. Who among the following sits third from the right end?

I. K sits at an extreme end of the row. J sits second to the right of K. Only one person sits between J and L. N sits on the immediate right of L.

II. N sits third to the right of M. Only one person sits between N and O. O sits to the right of N. L is an immediate neighbour of N.

Directions (6-10): Each of the questions below consists of a question and two statements numbered I and II given below it. You have to decide whether the data provided in the statements are sufficient to answer the question. Read both the statements and give answer

a) If the data in statement I alone are sufficient to answer the question, while the data in statement II alone are not sufficient to answer the question.

b) If the data in statement II alone are sufficient to answer the question, while the data in statement I alone are not sufficient to answer the question.

c) If the data either in statement I alone or in statement II alone are sufficient to answer the question.

d) If the data in both statement I and II together are not sufficient to answer the question.

e) If the data in both statement I and II together are necessary to answer the question.

6) Six persons N, P, Q, R, S and T are sitting in a circular table and facing center of the table. Who among the following sits opposite to Q?

I. S sits second to the right of N. T sits immediate left of P, who is not an immediate neighbour of S and N.

II. T sits second to the left of R. S sits fourth to the right of P, who is an immediate neighbour of R. S is not an immediate neighbour of R.

7) In what date does Manish attend the interview in Mumbai?

I. Manish's father correctly remembers that; Manish leaves for Mumbai one of the odd numbered dates after 6th but before 12th of the July.

II. Manish's wife remembers that; Manish attend the interview on one of the dates after 8th of July.

8) Ten persons are sitting in a straight row and facing north. How many persons sitting to the right of V?

Ultra Practice Bundle PDF for All Bank Prelims Exams

I. S sits third to the right of M and none of them sits at end of the row. Only two persons are sitting between V and S.
II. V sits second to the left of A, who sits from either ends of the row.

9) Seven persons J, H, G, F, D, S and A attends the exams on seven different days of the week starting from Monday to Sunday. Who among them attend the exam on Saturday?

I. J attends the exam on Wednesday. Only one person attends the exam between J and A. Only two persons attend the exam between S and G.

II. G attends the exam on Thursday. Only two persons attend the exams between G and S. F attends the exam immediately before S.

10) A, B, C, D, E and F are arranged according to their weight. Which of the following person is the lightest?

I. B is heavier than C but lighter than E. C is not the lightest.

II. D is heavier than only two persons. F is lighter than only one person.

Directions (11-15): Each of the following questions below consists of a question and two statements numbered I and II given below it. You have to decide whether the data provided in the statements are sufficient to answer the question. Read both the statements and give answer

a) If the data in statement I alone are sufficient to answer the question, while the data in statement II alone are not sufficient to answer the question.

b) If the data in statement II alone are sufficient to answer the question, while the data in statement I alone are not sufficient to answer the question.

c) If the data in either statement I alone or statement II alone are sufficient to answer the question.

d) If the data in both the statements I and II together are not sufficient to answer the question.

e) If the data in both the statements I and II together are necessary to answer the question.

11) On which day of the same week is Sarath exam scheduled (Monday being the first day of the week)?

I. Sarath correctly remembers that his exam is scheduled on a day after Tuesday, but before Thursday of the same week.

II. Sarath's father correctly remembers that Sarath's exam is scheduled on the third day of the week.

12) How many marks has Supriya scored in the test? (Maximum marks 20)

I. Supriya scored two-digit marks. Her marks were not in decimals.

II. Supriya scored more than 9 marks in the test.

13) In which month of the year did Magesh go abroad for a vacation?

I. Magesh correctly remembers that he went for a vacation in the first half of the year.

II. Magesh wife correctly remembers that they went for a vacation after 31st March but before 1st May.

14) In which direction is point A, with reference to point B?

I. Point D is to the east of point A. Point A is to the south of point F.

II. Point F is to the north-west to point B. Point D is to the north of point B.

15) Among V, W, X, Y and Z seated in a straight line facing south, who sits at the extreme end of the row?

I. W sits second to right of V. Z is not immediate neighbour of Y.

II. V sits third to left of Y. W sits on the immediate right of X.

Directions (16-20): Each of these questions below consist of a question and two statements I and II given

Ultra Practice Bundle PDF for All Bank Prelims Exams

below it. You have to decide which of these statements are sufficient to answer the given questions. Read both the statements and give answer

- a) Data in statement I alone is sufficient
- b) Data in statement II alone is sufficient
- c) Data in statement I alone or statement II alone is sufficient
- d) Data given in both statement I and statement II together are not sufficient
- e) Data in both statement I and statement II together are sufficient

16) Seven persons P, Q, R, S, T, U and V are sitting in a straight line facing north. Who among the following sits second to the left of S?

- I) There are only two persons sitting between R and Q, who sits to the right of R. V is not an immediate neighbour of Q. S is not an immediate neighbour of R, who does not sit at any of the extreme end.
- II) T sits third to the left of P and both of them does not sitting at the extreme ends. P is an immediate neighbour of Q. Not more than one person sits to the left of R. V sits to the right of S.

17) How is D related to A?

- I) B is the mother of E, who is the niece of C. F is the father-in-law of D.
- II) C is the son of F. D does not have any siblings. A is the mother of C.

18) What is the code for the word 'Place'?

- I) 'market place good for' is coded as 'mn tk vx az' and 'daily market in city' is coded as 'vk rs tk bm'.
- II) 'good commuters are valid' is coded as 'st uw mn cd' and 'valid city some issue' is written as 'cd po rs qn'

19) Five persons M, N, O, P and Q are attending the seminar on five different days of the same week starts

from Monday to Friday. P attends the seminar on which of the day?

- I) Only one person attends the seminar between M and N. Only one person attends the seminar after Q. P attends the seminar in one of the days before Q but not on Monday.
- II) Only two persons attend the seminar after M. O attends the seminar immediately after Q, who does not attend the seminar first day of the week. There are two persons attend the seminar between Q and N.

20) There are 40 students in a class. What is the rank of K from top?

- I) M is 18th rank from top. L is 13th rank from last and K ranked exactly between M and L.
- II) Z is 22nd rank from top. There are only three persons ranked between Z and K.

Directions (21-22): Each of the questions below consists of a question and two statements numbered I and II given below it. You have to decide whether the data provided in the statements are sufficient to answer the question. Read both the statements and give answer

- a) If the data in statement I alone are sufficient to answer the question, while the data in statement II alone are not sufficient to answer the question.
- b) If the data in statement II alone are sufficient to answer the question, while the data in statement I alone are not sufficient to answer the question.
- c) If the data either in statement I alone or in statement II alone are sufficient to answer the question.
- d) If the data in both statement I and II together are not sufficient to answer the question.
- e) If the data in both statement I and II together are necessary to answer the question.

Ultra Practice Bundle PDF for All Bank Prelims Exams

21) Seven persons T, L, M, H, D, Q and Z are in a family. There are three married couples in a family.

How is L related to Q?

- I) M is maternal grandfather of H. Z is brother in law of D. Z has no siblings.
- II) T is only daughter in law of L. L and M are married couples. D is maternal uncle of H.

22) Six persons A, B, E, F, G and H are arranged according to their height. Find the second shortest person.

- I) A is taller than G but shorter than F. B is taller than E and H. Only two persons are shorter than G. F is not the tallest. E is not the shortest.
- II) More than two persons are taller than E. F is taller than A and G. H is shorter than E. B is taller than A.

Directions (23-27): Read the following information carefully and answer the questions given below.

- a). Only Statement I is sufficient to answer
- b). Only Statement II is sufficient to answer
- c). Either Statement I or Statement II are sufficient to answer.
- d). Neither Statement I nor Statement II are sufficient to answer.
- e). Both Statement I and Statement II are sufficient to answer.

23) How many chocolate does Seetha has?

- I) Abi has 10 chocolates which is five more than Geetha. Seetha has 2 chocolates more than Swetha, who has 2 more than Geetha.
- II) Swetha has more chocolates than Geetha but less than Abi, who has 10 chocolates.

24) On which day does Arun took his leave?

- I) Arun does not took his leave on Wednesday.
- II) Arun took his leave either on Monday or Thursday.

25) Who among the following was oldest among A, B, C, D, E, F?

- I) A is older than C but not older than B. D is not older than C.
- II) D was older than both E and F.

26) P, Q, R, S, and T are the five persons in the group. How many persons are taller than T?

- I) P is taller than Q, who was only shorter than P and T.
- II) R is shorter than P, who was shorter than T.

27) On which floor does C lives? If A, B, C, D, E are living in a building. The lowermost floor of the building is numbered 1 its above floor numbered 2 and so on till the topmost floor of the building is numbered 5.

- I) A lives one of the floor below D, who lives in topmost floor.
- II) E lives two floors above C, who neither lives in third Nor second floor.

Direction (28-32): Each of the questions below consists of a question and two Statements I and II given below it. You have to decide whether the data provided in the statements are sufficient to answer the question. Read both the statements and Give answer

- a) If the data in Statement I alone are sufficient to answer the question, while the data in Statement II alone are not sufficient to answer the question
- b) If the data in Statement II alone are sufficient to answer the question, while the data in Statement I alone are not sufficient to answer the question
- c) If the data either in Statement I alone or in Statement II alone are sufficient to answer the question
- d) If the data given in both the Statements I and II together are not sufficient to answer the question
- e) If the data in both the Statements I and II together are necessary to answer the question

Ultra Practice Bundle PDF for All Bank Prelims Exams

28) How is 'of' written in a code language?

- I. 'central bank of India' is written as '5 3 9 6' in that code language.
II. 'bank of baroda' is written as '7 3 5' in that code language.

29) How is D related to E?

- I. D is sister of M and B.
II. E is mother of M.

30) Among P, Q, R, S and T, who is the heaviest?

- I. R is heavier than only P.
II. S is lighter than Q but heavier than R and T.

31) K is towards which direction of D?

- I. D is towards North of N.
II. D is towards South of T which is towards West of K.

32) Who among B, C, D and W reached office first?

- I. C reached office after W but before B and D.
II. B reached office after D

Direction (33-50): Each of the following questions below consists of a question and two statements numbered I and II given below it. You have to decide whether the data provided in the statements are sufficient to answer the question. Read both the statements and give answer.

- a) If the data in statement I alone are sufficient to answer the question, while the data in statement II alone are not sufficient to answer the question.
b) If the data in statement II alone are sufficient to answer the question, while the data in statement I alone are not sufficient to answer the question.
c) If the data in either statement I alone or statement II alone are sufficient to answer the question.
d) If the data in both the statements I and II together are not sufficient to answer the question.

e) If the data in both the statements I and II together are necessary to answer the question.

33) Who among Jaya, Kavya, Lokesh and Mani reached home first?

- A) Jaya reached home after Lokesh and before Mani but did not second last to reach home.
B) Kavya reached home after Mani.

34) Among Akansha, Banya, Caryl, Dinesh and Elvish each one of them has different height, who among the following is the second shortest?

- I) Dinesh is taller than Akansha and Banya.
II) Elvish is shorter than Caryl and taller than Dinesh.

35) There are five persons in a family namely Pz, Qz, Rz, Sz and Tz. How is Sz related to Pz?

- I) Tz is cousin of Pz and son of Qz, who married to Sz.
II) Rz is father of Pz and brother of Sz. Qz is wife of Sz.

36) Among Akansha, Banya, Caryl, Dinesh, Elvish and Farah are sitting in a circle facing center, who among the following person sit immediate right of Dinesh?

- I) Akansha faces Banya. No person sits between Banya and Dinesh.
II) Dinesh sits second to the right of Akansha, Who sits immediate left of Caryl.

37) Seven boxes are placed one above other which of the following box is placed immediately above the Box Hx?

- I) Three Box are placed between Box Bx and Fx, which is placed immediately above box Lx.
II) Three box are placed between Box Lx and Box Hx. Box Lx is placed below box Hx.

38) Who among Priyal, Queen, Rashi and Shivani is sitting immediate right to Priyal if all persons are sitting in a straight line facing north?

- I) Priyal does not sit with to Shivani who does not sit to the extreme right.

Ultra Practice Bundle PDF for All Bank Prelims Exams

II) None sit to the left of Priyal and on the right of Queen, while only one person sits between Rashi and Queen.

39) If all persons are facing same direction, then how many persons are sitting in a row?

I) Akansha is on 11th position from the left end of the row. Brijesh is on 8th position from the right end of the row.

II) Manish is 5th to the right of Akansha and 5th to the left of Brijesh.

40) Who is tallest among five friends Akalya, Banya, Caryl, Diya and Elvish?

I) Diya is taller than at least two of his friends

II) Elvish is taller than Akalya who is taller than Diya.

41) What is Akash's rank in the class of 30 Students?

I) Brijesh, who is 11th from the top in the class. Akash is exactly between Brijesh and Caroline, who is 16 from the bottom.

II) Akash who is 10 rank above Brijesh who is 15th rank below Caroline.

42) Towards which direction was Rashi facing as she stopped running?

I) Rashi run 30 meters towards West, took a left turn and run 20 meters. She again took a left turn and stopped after running 30 meters.

II) Rashi run 30 meters towards East, took a right turn and run 20 meters. Then she took a left turn and stopped after running 30 meters.

43) Who is tallest among five friends Priyanka, Queen, Risabh, Shivani and Taruna?

I) Shivani is taller than Risabh but just shorter than Taruna.

II) Taruna is shorter than Priyanka and Queen is shorter than Taruna.

44) How is Kz related to Mz?

I) Mz is Qz's father's only sister.

II) Nz is mother Kz who is the daughter of Oz.

45) By using which statements, we can conclude "All H are T".

I) All H are S. No S is P. All S are T.

II) All H are S. Some P are S. No P are T.

46) How is 'systematic' written in a code language?

I) 'systematic money process' is written as 'xm nu zx' and 'money would fun' is written as 'zx zy iz' in that code language.

II) 'systematic icecream process' is written as 'xm nu zm' in that code language

47) Priyanshi is towards which direction from Queen?

I) Zashn is in south of Queen and west of Srikant, who is in north of Manish.

II) Manish is south of Srikant and west of Priyanshi.

48) How Az is related to Sz?

A) $Mz = Rz \geq Sz > Tz \geq Kz \leq Lz$

B) $Az = Bz < Tz = Nz > Fz = Gz$

49) How Px is related to Mx?

I) Qx is daughter-in-law of Mx, who is son of Sx.

II) Tx is mother in law of Px, who is son-in-law of Ux. Ux has only one grand-daughter Rx, who is daughter of Qx. Ux has only one child.

50) Who among Az, Bz, Cz, Dz, Ez and Fz is the shortest?

I) Dz and Cz are taller than Az but both shorter than Fz. Bz is taller than Az.

II) Fz is shorter than Ez but taller than Bz and Dz. while Az is not tallest.

Answers with Detailed Explanation

Answers (1-5):



Ultra Practice Bundle PDF for All Bank Prelims Exams

1) In this question, we have to look after both the statements.

I. As per the first statement diagram will be as follows:

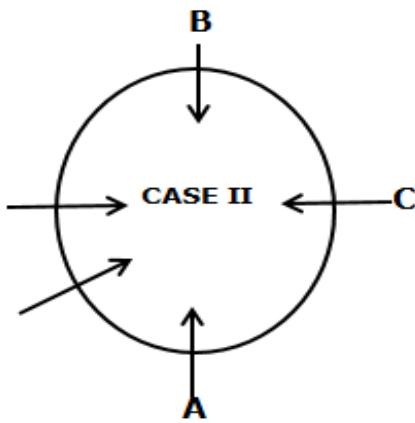
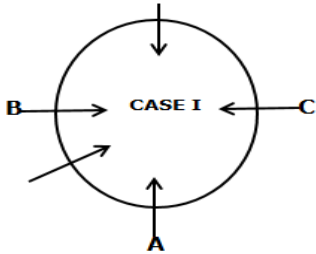

Now as per this diagram only I option will get eliminated as we cannot determine who sits second to the right of C as there can be two possible cases.

II. As per the second statement diagram will be as follows:

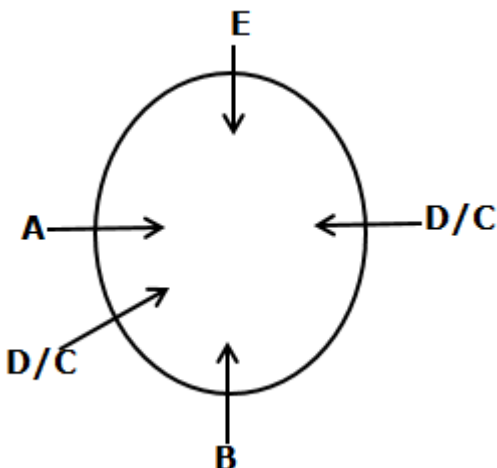

Now as per this diagram, we cannot determine the person who sits second to the right of C, so the only statement 2 will get eliminated

Now after both the statements getting individually eliminated, we will combine both these statements and the final diagram will look like this:

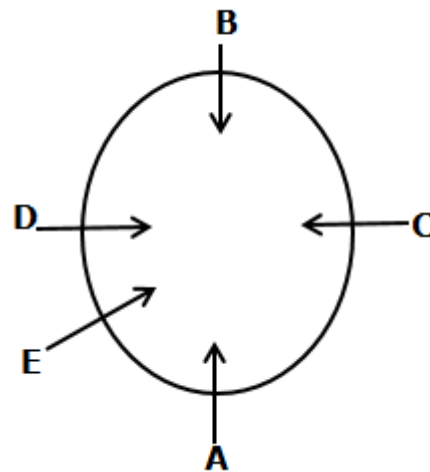

By this diagram, we can say that person who sits second to the right of C will be D

So, answer will be Both These Statements

Answer: E (Both)

2) In this question, we have to look after both the statements

I. As per this statement, we will have two following cases:

CASE I:

M can be the heaviest and P can be lightest

$$M > _ > O > _ > P$$

CASE II:

M will be the second heaviest and P will be the second lightest

$$_ > M > O > P > _$$

Ultra Practice Bundle PDF for All Bank Prelims Exams

From this statement, it is not clear that who is the heaviest, so this statement will get eliminated and we cannot use this statement individually

II. As per this statement, diagram will be as follows:

$$M > L > O > N > P$$

So from this statement we can conclude that M is the heaviest

So, answer will be Only II

Answer: B (Only II)

3) In this question, we have to analyse both the statements
I. As per this statement only two numbers are there between 21 and 32 which are divisible by 6 that is 24 and 30 but we cannot conclude the number of students in the class.

II. From this statement, we cannot conclude that how many students are there in the class 10 as the difference between class 7 and class 10 is less than nine, so difference between both the classes can be any number between 1 to 8.

After getting eliminated both the options individually, we will combine both the statements

After combining both the statements, we can conclude that difference between class 7 students and class 10 students is less than 9 and that number must be divisible by 6, so there will be only one number that is 30

So, answer is 30

Answer: E (Both)

4) In this question also, we will analyse both the statements.

I. As per this statement, we will have two possible cases:

CASE I

When C is living on floor number 2

Floor	Name of Persons
6	
5	F
4	
3	
2	C
1	

CASE II

When C is living on floor number 4

Floor	Name of Persons
6	
5	
4	C
3	
2	
1	F

CASE II will get eliminated as A lives below F and this is not possible.

Now in this option, we cannot determine the number of persons sitting between A and D, so this option will get eliminated individually.

II. As per this statement also, we will have two case and they are as follows:

CASE I

When B is living on the topmost floor and D is living on the bottommost floor

Floor	Name of Persons
6	B
5	C
4	
3	
2	



Ultra Practice Bundle PDF for All Bank Prelims Exams

1	D
---	---

This case will get eliminated as F lives immediately below D, which is not possible.

CASE II

When B is living on the bottom most floor and D is living on the top most floor

Floor	Name of Persons
6	D
5	F
4	
3	
2	C
1	B

Now, this option will also get eliminated individually as we cannot conclude that where A is sitting

Now we will combine both the statements and as per both the statements we cannot conclude the place of A Where A is sitting

So, answer will be both the statements are not sufficient to answer the question.

Answer: D

5) In this question we will solve both the statements individually.

1) As per this statement, we will have two possible cases:

CASE I:

When K sits at extreme left end.

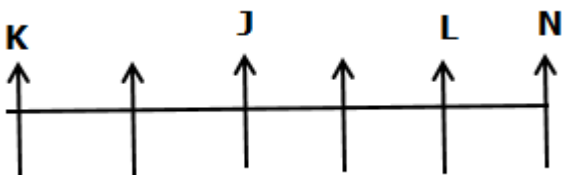

CASE II:

When K sits at extreme right end.

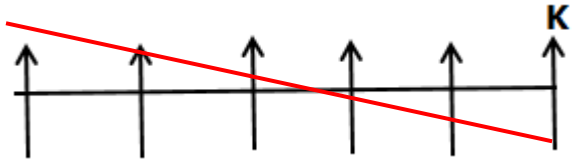

This case will get eliminated as J cannot sit second to the right K.

II. As per this statement, diagram will look like this:

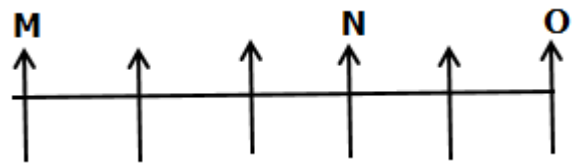

As per this statement, position of L cannot be determined as there are 2 possibilities for the position of L but through this statement we can find, the person, who sits third from the right end that is N

So, answer is N

Answer: B

Answers (6-10):

6) In this question we will have a look a look at both the statements separately.

I. As per this statement, diagram will look like this:

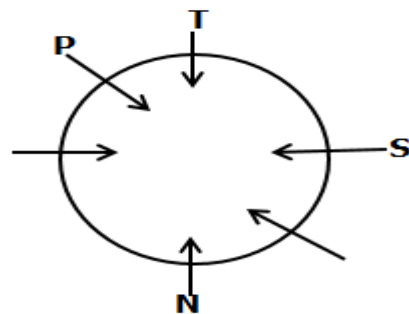

Now, as per this statement we cannot find that who sits opposite to Q, so this option will get eliminated individually

II. As per this statement, we will have two cases and cases will look like this:



Ultra Practice Bundle PDF for All Bank Prelims Exams

CASE I:

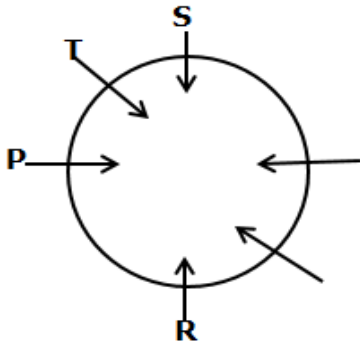

CASE II

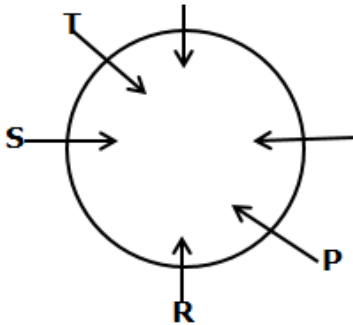

Now as per this statement also, we cannot find the position and the one, who sits opposite to Q, so this option will also get eliminated individually.

Now, we will combine both the statements and the diagram will look like this:

CASE II:

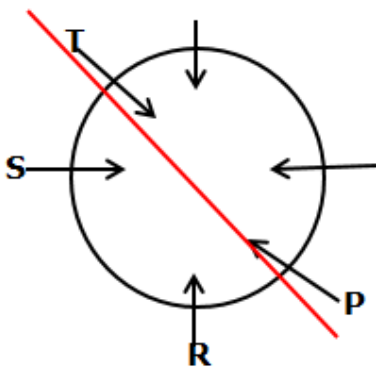

This case will get eliminated as after combining both the statements, T sits immediate left of P but in this case this is not happening.

CASE I:

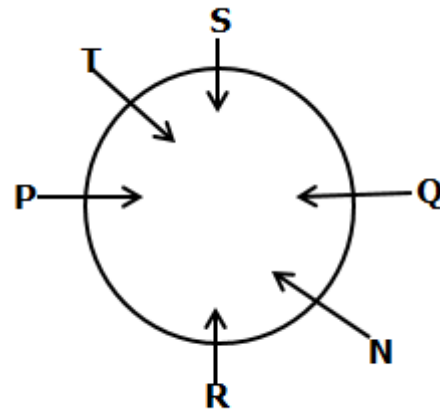

Now after combining both the statements, we can say that P sits opposite to Q.

So, answer is P

Answer: E

7) In this question, we will have a look at both these statements:

I. As per Manish's father, Manish leaves for Mumbai after 6th and before 12th July but on the odd numbered date, so between 6 and 12 there are three odd numbers that is 7, 9 and 11

So, this option will get eliminated individually as it is not clear that on which date Manish leaves for Mumbai.

II. As per Manish's wife Manish attends the interview after 8th July as there are 'n' number of possibilities that on which date Manish will attend the interview

So, this option will also get eliminated individually

Now, we will combine both the statements

From both these statements after 8th there are only 2 odd number that is 9 and 11, so after combining also this is not clear that Manish leaves for Mumbai on which date

So, answer will be both the statements are not sufficient to answer the question

Answer: D



Ultra Practice Bundle PDF for All Bank Prelims Exams

8) In this question, we will analyse both the statements separately.

I. As per this statement, S sits third to the right of M and none of them sits at end of the row.

By this statement there are multiple possibilities for the sitting of M and S

So, this option will get eliminated individually as we cannot decide how many people are sitting to the right of V.

II) As per this statement, diagram will look like this:



Now, if we will look at the diagram, then we can clearly see that there are two persons sitting to the right of V

So, the answer is two

Answer: E

9) In this question, we will look after the both the statements separately.

I. As per this statement, we will have two possible cases and they are as follows:

CASE I:

Days	Name of Persons
Monday	A
Tuesday	
Wednesday	J
Thursday	
Friday	
Saturday	
Sunday	

CASE II:

Days	Name of Persons
Monday	
Tuesday	

Wednesday	J
Thursday	
Friday	A
Saturday	
Sunday	

Now, in this statement only two persons will sit between S and G and as per this statement there are multiple possibilities for this sentence, so this option will get eliminated individually.

II. As per this statement, we will have two possible cases and they will look like this:

CASE I:

Days	Name of Persons
Monday	S
Tuesday	
Wednesday	
Thursday	G
Friday	
Saturday	
Sunday	

Now, in this case F will attend the exam immediately before S, which is not possible, so this case will get eliminated.

CASE II:

Days	Name of Persons
Monday	
Tuesday	
Wednesday	
Thursday	G
Friday	
Saturday	F
Sunday	S

Now, from this statement, we can find that F attends the exam on Saturday.

So, answer is F

Ultra Practice Bundle PDF for All Bank Prelims Exams

Answer: B

10) We will look into both the statements separately.

I. As per this statement diagram will look like this:

$E > B > C > _$

From this diagram, we can't conclude who is the lightest, so this option will get eliminated individually.

II. From this statement, we can conclude this diagram:

$_ > F > _ > D > _ > _$

From this diagram as well, we can't tell that who is the lightest.

So this option will also get eliminated individually.

Now, we will combine both the options and after combining both the options we can conclude this diagram:

$E > F > B > D > C > A$

Now, after both these statements we can conclude that A is the lightest.

So, answer is both these statements are necessary.

Answer: E

Answers (11-15):

11) We will analyse both the statements separately.

I. From this statement, we can conclude that Sarath's exam is scheduled on Wednesday.

II. And from this statement also, we can conclude that Sarath's exam is scheduled on Wednesday.

So from both these statements, answer can be concluded, so answer will either I or II statement is necessary to answer the question.

Answer: C

12) We will look after both these statements separately.

I. As per these statements Surpiya's marks can be anything after 9 till 20

So this statement will get eliminated individually.

II. As per second statement, Supriya scored more marks than 9 and there can be multiple possibilities about the marks of her

So, this statement will also get eliminated individually

Now after combining both the statements, then also we cannot conclude the marks of Supriya

So, answer will be both the statements are not sufficient to answer the question.

Answer: D

13) In this question we will analyse each statement separately.

I. As per this statement Magesh go to abroad in the first half of the year, so there are 6 months available in which he can go.

So, this statement will get eliminated individually

II. As per this statement Magesh go to abroad after 31st March and before 1st May and from this we can conclude that Magesh go to abroad in the month of April

So, answer is only second statement is alone sufficient to answer the question

Answer: B

14) In this question we will have a look at both the statements separately.

I. As per this statement diagram will look like this:



As per this diagram, we cannot conclude that in which direction is A with respect to B

So, this option will get eliminated individually.

II. As per this statement diagram will look like this:



Ultra Practice Bundle PDF for All Bank Prelims Exams

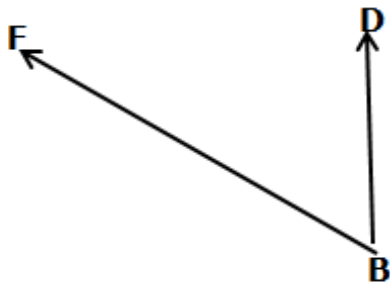

As per this statement, we cannot conclude that in which direction is A with respect to B
So, this option will get eliminated individually.

Now, we will combine both the statements and the diagram will look like this:

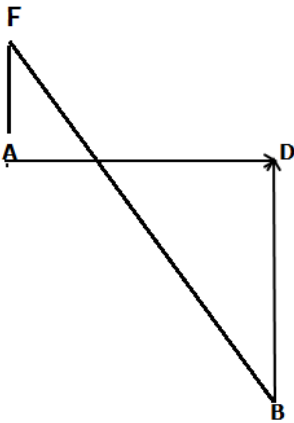

I. Point D is to the east of point A. Point A is to the south of point F.
II. Point F is to the north-west to point B. Point D is to the north of point B.

As per seeing the diagram, we can conclude the direction of A with respect to B and that North West
So, answer will be North West

Answer: E

15) In this question we will analyse both the statements separately.

I. As per this statement, diagram will look like this:

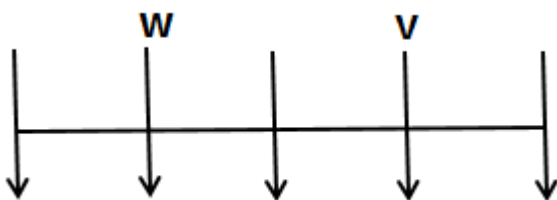

As per this statement, it is not clear that who sits at extreme end of the row.

So this option will get eliminated individually

As per this statement, it is not clear that who sits at extreme end of the row.

So this option will get eliminated individually

II. According to this statement, there are two possible cases and diagrams will look like this:

CASE I:

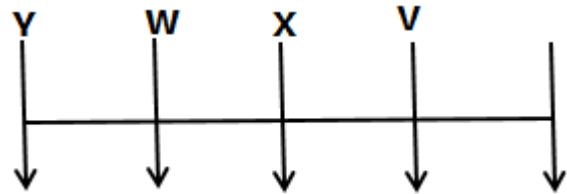

CASE II:

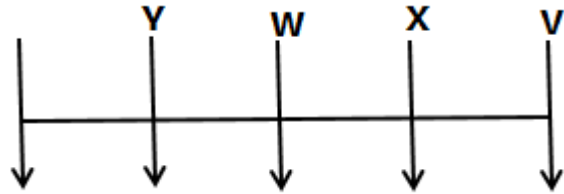

After going both the cases, in one case Y is sitting at the extreme end and in other case V is sitting.

As we cannot draw the exact conclusion that who will be sitting at the extreme end, this option will also get eliminated individually.

Now we will combine both these statements and the diagram will look like this:

CASE II will get eliminated because as per first statement Z is not immediate neighbour of Y.

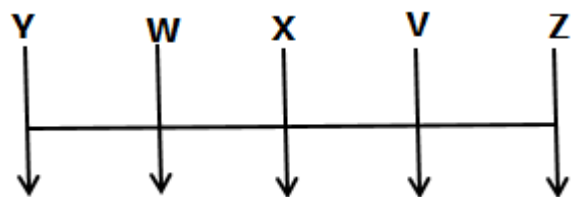



Ultra Practice Bundle PDF for All Bank Prelims Exams

So, answer is both the statements are necessary to answer the question.

Answer: E

Answers (16-20):

16) We will analyse both the statements separately.

I. As per this statement there are three cases possible and they are as follows:

CASE I:



CASE II:



CASE III:



From this statement it is not clear that who sits second left of S

So this option will get eliminated individually.

II. As per this statement there are two possible cases and they will look like this:

CASE I:



CASE II:



By this statement, we cannot confirm the seat of Q and other information is also not conclusive

So, this option will get eliminated individually.

Now we will combine both these statements and the diagram will look like this:

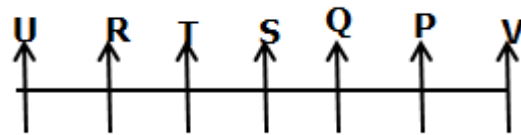

Now, we can conclude that R sits second to the left S.

So, answer will be both the statement are necessary to answer the question.

Answer: E

17) We will look at both the statements separately.

I. As per this statement, the family tree will look like this:

I) B is the mother of E, who is the niece of C. F is the father-in-law of D.

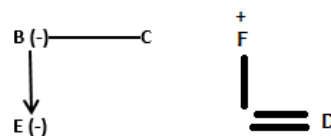

Now if we look at the diagram, we cannot conclude the relation between D and A.

So, this option will get eliminated individually.

II. As per this statement, family three will look like this:

II) C is the son of F. D does not have any siblings. A is the mother of C.

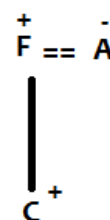

Ultra Practice Bundle PDF for All Bank Prelims Exams

Now, as per this statement we cannot establish the relation between A and D

So, this option will get individually.

Now, we will combine both the statements and the family tree will look like this:

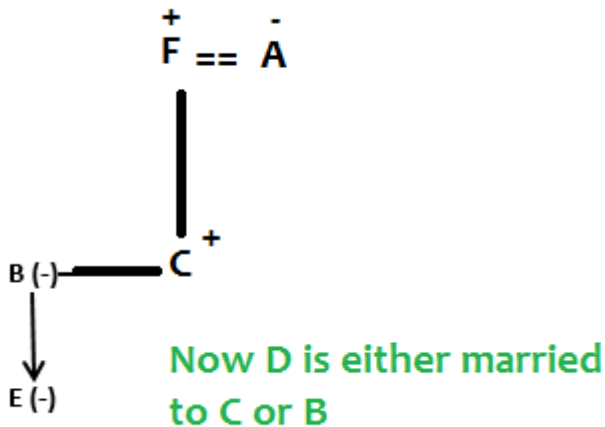

After looking at the family tree we cannot establish the gender of D so information here is insufficient to answer the question

Answer: D

18) We will analyse both the statements separately.

I. As per this statement, we can conclude that

Code for Market will be tk

Rest codes for the words are unknown, so this option will get eliminated individually.

II. As per this statement, we can conclude that

Code for Valid will be cd

Rest codes for the words are unknown, so this option will get eliminated individually.

Now, we will combine both the statements, and from that we can conclude that:

Market: tk

Valid: cd

City: rs

Good: mn

Place: vx/az

As the code of place is not clear, so information given here is not sufficient.

Answer: D

19) We will look after both the statements separately

I. As per this statement arrangement will be like this:

Days	Name of Persons
Monday	M/N
Tuesday	P
Wednesday	M/N
Thursday	Q
Friday	M/N

From this statement, we can conclude that P will attend the seminar on Tuesday

II. As per this statement arrangement will be like this:

Days	Name of Persons
Monday	N
Tuesday	P
Wednesday	M
Thursday	Q
Friday	O

From this statement also we can conclude that P attends the seminar on Tuesday.

So, from these statements answer can be concluded, so we can take any of the statement to arrive at the answer.

Answer: C

20) We will analyse both the statements separately.

I. According to this statement diagram will look like this:

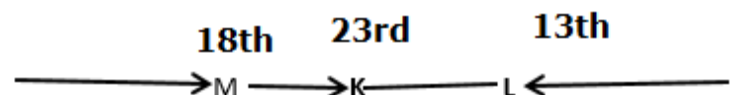



Ultra Practice Bundle PDF for All Bank Prelims Exams

As per this statement we can conclude the rank K from the top.

II. As per this statement we can conclude that: Z ranks 22nd from the top and there are three people between Z and K, so K can be before Z and can be after Z. As this information is not clear, we can conclude that this statement will not be sufficient to answer the question.

Answer: A

Answers (21-22):

21) We will look after both the statements separately.
I. As per this statement family tree will look like this:

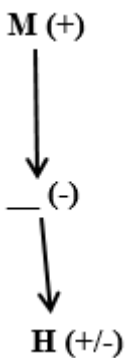

As per this diagram we cannot conclude the relation between Q and L. So this option will get eliminated individually.

II. As per this statement, diagram will look like this:

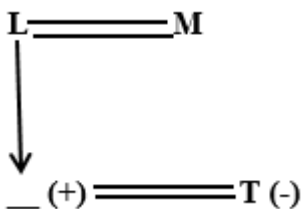

As per this statement, we cannot establish the relationship between L and Q. So, this statement will get eliminated individually.

Now, we will combine both these statements and the family tree will look like this:

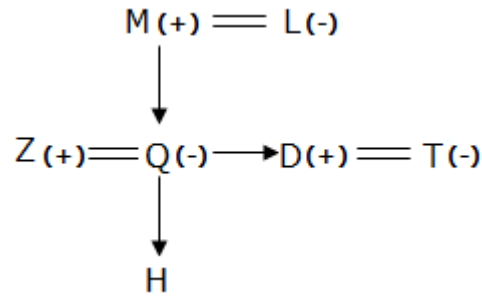

L is mother of Q. Thus both statements I and II are necessary to answer.

21. E (Answer)

22) We will analyse both these statements separately.
I. As per this statement arrangement will look like this:

B > F > A > G > E > H

So from this arrangement we can conclude that E is the second shortest person.

II. As per this statement, we can conclude that:

F > A & G
E > H
B > A

From this arrangement we can conclude that who is the second shortest person.

So this option will get eliminated individually.

Answer: A

Answers (23-27):

23) We will analyse both these statements separately.

I. From this statement, we can conclude that:

- Abi: 10 Chocolates
- Geetha: 5 Chocolates
- Swetha: 7 Chocolates
- Seetha: 9 Chocolates

From this statement we can arrive at the answer.

II. From this statement, we can conclude that:

Ultra Practice Bundle PDF for All Bank Prelims Exams

Abi has 10 chocolates and Swetha has less number of chocolates than Abi, and there are multiple possibilities for the number of chocolates for the Swetha and the number of chocolates Seetha has no information in this statement.

So, this option will get eliminated individually.

Answer: A

24) We will look after both the statements separately

I. As per this statement we cannot conclude when Arun took his leave

II. As per this statement also, we cannot conclude the day when Arun took his leave

So, both these statement are not sufficient enough to answer the question.

Answer: D

25) In this question we will solve both the statements separately.

I. According to this statement, we can conclude this:

B>A>C>D

From this arrangement, we cannot conclude that who is the oldest as the information about two persons is not given.

So, this statement will be eliminated individually.

II. According to this statement, we can conclude this:

D> E and F

From this statement as well, we cannot conclude who is oldest.

So, this statement will be eliminated individually.

Now we will combine both these statements and we can conclude this:

B>A>C>D>E/F>E/F

So from this arrangement it is clear that B is the oldest.

So, answer is both these statements are necessary to answer the question

Answer: E

26) We will solve both the statements separately.

I. As per this statement, we can conclude that:

T, P>Q

From the above information it is not clear that how many persons are taller than T

So, this option will get eliminated individually.

II. According to this statement, we can conclude this:

T>P>R

From the above information it is not clear that how many persons are taller than T

So, this option will get eliminated individually.

Now we will combine both these statements and we can conclude this:

T > P > Q > R > S

or

T > P > Q > S > R

From both these cases, we can conclude that no one is taller than T

So, answer will be both these statements will be necessary to answer the question

Answer: E

27) We will solve both these statements separately.

I. As per this statement, we can conclude that:

Floor	Number of Persons
5	D

Ultra Practice Bundle PDF for All Bank Prelims Exams

4	
3	
2	
1	

From this statement, we cannot conclude that below D on which floor A is living

So, this option will get eliminated individually

II. From this statement, we can conclude this:

Floor	Number of Persons
5	
4	
3	E
2	
1	C

From this statement, we can conclude that C lives on first floor.

Answer: B

Answers (28-32):

28) We will solve both the statements separately.

I. As per this statement we cannot get the coder of any word

So this option will get eliminated individually

II. As per this statement we cannot get the coder of any word

So this option will get eliminated individually

Now, we will combine both these statements, and we can conclude that:

Bank/Of: 3/5

From both these statements, we cannot get the code of "Of"

So, answer will be both the statements are not sufficient to answer the question.

Answer: D

29) In this question we will analyse both the statements separately

I. As per this statement, we can conclude this:

$D (-) \text{ ————— } M (+/-) \text{ ————— } B (+/-)$

From this statement, we cannot conclude the relation between D and E

So, this option will get eliminated individually

II. As per this statement, we can conclude this:

$E (-)$
↓
 $M (+/-)$

From this statement, we cannot conclude the relation between D and E

So, this option will get eliminated individually.

Now, we will combine both these statements, and we can conclude this:

$E (-)$
↓ ↘
 $M (+/-) \text{ ————— } D (-) \text{ ————— } B (+/-)$

Answer: E

30) We will analyse both the statements separately

I. As per this statement, we can conclude that R is heavier than only P and the rest are heavier than R so we cannot conclude that who is the heaviest of them all.

So, this option will get eliminated individually.

II. As per this statement we, can conclude this:

Q>S>R and T

From this analysis, we cannot conclude who is the heaviest

So this option will also get eliminated individually

Ultra Practice Bundle PDF for All Bank Prelims Exams

Now, we will combine both these statements and we can conclude this:

Q > S > T > R > P

So, answer is Q is the heaviest

So, we need both these statements to answer the question

Answer: E

31) In this question, we will solve both these statements separately.

I. From this statement we can conclude that D is in North of N and we cannot conclude that K is in which direction with respect to D

So, this option will get eliminated individually.

II. From this statement, we can conclude this:

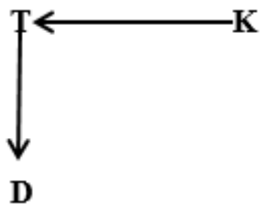

So, from this diagram we can say that K is in North East direction with respect to D

So, answer will be only second statement is sufficient to answer the question.

Answer: B

32) We will look after both the statements separately

I. As per this statement we can conclude this:

W > C > (B, D)

From this statement, we can conclude that W reached first.

II. From this statement, we can conclude that D reached before B but we cannot conclude any information who reached first.

So this option will get eliminated individually

So, answer will be only I statement is sufficient to answer the question

Answer: A

Answers (33-50):

33) We will analyse both the statements separately.

I. As per this statement, we can conclude this:

Lokesh > Jaya > Mani > Kavya

From this statement, we can say that Lokesh reached first.

II. As per this statement, we can conclude that Kavya reached after Mani, but we cannot say who reached first.

So this statement will get eliminated individually

So, answer will be only I statement is sufficient to answer the question

Answer: A

34) In this question will have a look at both the statements separately.

I. As per this statement, we can say that Dinesh is taller than Akansha and Banya but we do not have any information about the remaining persons.

So, this option will get eliminated individually

II. According to this statement, we can conclude this:

Caryl > Elvish > Dinesh

From this we cannot conclude that who is the second shortest.

So this statement will get eliminated individually.

Now, we will combine both the statements and we can conclude this:

Caryl > Elvish > Dinesh > Akansha/Banya > Akansha/Banya

From this statement as well we cannot conclude that who is the second shortest.

So, answer will be both the statements are not sufficient to answer the question

Answer: D

35) We will analyse both the statements separately



Ultra Practice Bundle PDF for All Bank Prelims Exams

I. As per this statement we can conclude this:

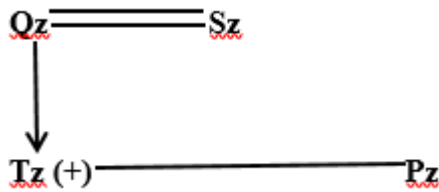

As per this statement, we cannot conclude the relation between Sz and Pz as the gender of both these persons is unknown.

So this option will get eliminated individually.

II. As per this statement, we can conclude this:

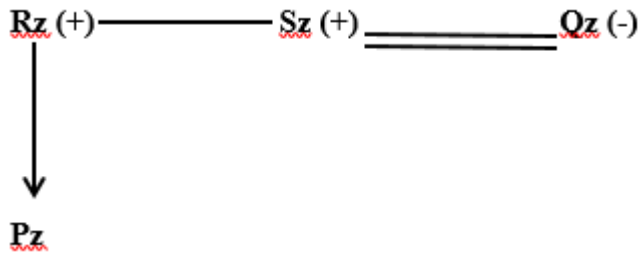

As per this statement, Sz is the uncle of Pz
So, answer will be only II statement is sufficient to answer the question

Answer: B

36) We will analyse each statement separately.

I. As per this statement we will have two cases:

CASE I:

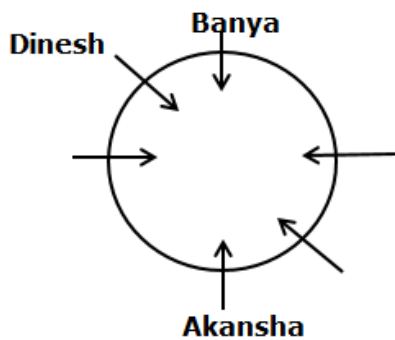

CASE II:

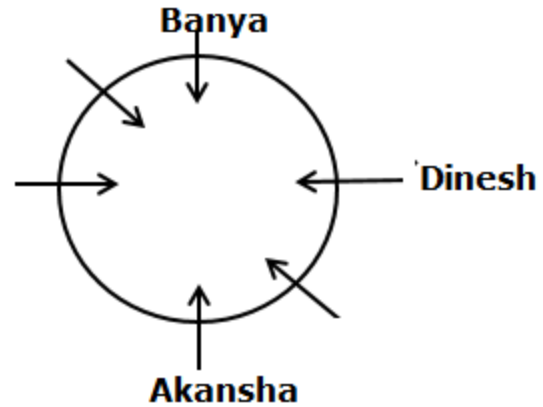

From both these cases we cannot conclude that who sits immediate right of Dinesh

So, this option will get eliminated individually

II. As per this statement, we can conclude this:

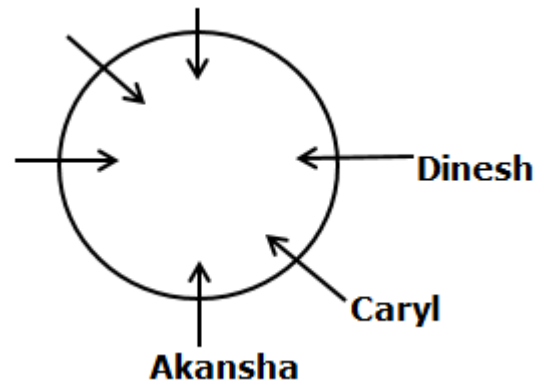

From this statement also, we cannot conclude who sits immediate right of Dinesh

So, this option will get eliminated individually.

Now, we will combine both these statements and we can conclude that after combining as well Banya will sit to immediate right of Dinesh.



Ultra Practice Bundle PDF for All Bank Prelims Exams

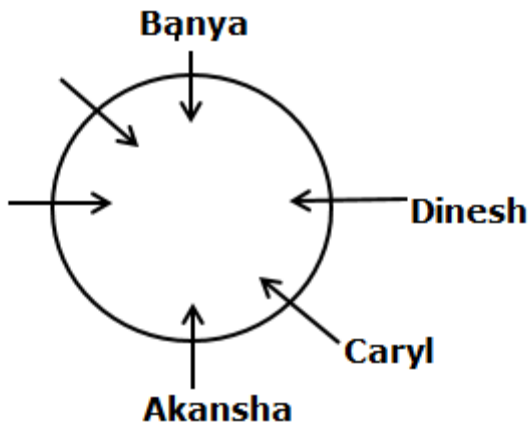

So, answer will be both these statements are necessary to answer the question.

Answer: E

37) We will analyse both these statements separately.

I. As per this statement we get multiple possibilities.

From this statement, we cannot conclude that which box is immediately above the box Hx.

So, this option will get eliminated

II. As per this statement, we can conclude this:

Boxes Number	Boxes	Boxes	Boxes
7	Hx		
6		Hx	
5			Hx
4			
3	Lx		
2		Lx	
1			Lx

From this statement also, we cannot conclude that which box is immediately above Hx

So, this option will get eliminated individually

Now, we will combine both these statements and we can conclude this:

Boxes Number	Boxes	Boxes
7	Bx	

6	Hx	Bx
5		Hx
4		
3	Fx	
2	Lx	Fx
1		Lx

From this statement, we can conclude this, that Bx lives immediately above Hx

So, answer will be both these statements are necessary to answer the question.

Answer: E

38) In this question we will solve each statement separately

I. As per this statement, we cannot conclude that who sits immediate right of Priyal

So, this option will get eliminated individually

II. As per this statement, we can conclude this:

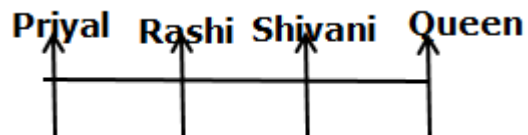

Now as per this statement, we can conclude that Rashi sits to the immediate right of Priyal.

So, answer will be only II statement is sufficient to answer the question

Answer: B

39) We will analyse the statements separately

I. As per this statement we can conclude this:



Now in this statement, we cannot conclude that is there any between Akansha and Brijesh or not

So, this option will get eliminated individually.

Ultra Practice Bundle PDF for All Bank Prelims Exams

II. As per this statement we can conclude this:

Akansha $\xrightarrow{5th R}$ Manish $\xleftarrow{5th L}$ Brijesh

Now from this statement, we cannot conclude the number of persons sitting in the row.

So, this option will get eliminated individually.

Now, we will combine both the statements and we can conclude this:

$\xrightarrow{11th L}$ Akansha $\xrightarrow{5th R}$ Manish $\xleftarrow{5th L}$ Brijesh $\xleftarrow{8th R}$

Now, from this statement we can conclude the number of persons sitting in the row.

So, answer will be both the statements will be needed to answer the question

Answer: E

40) We will analyse the statements separately.

I. As per this statement, we cannot conclude that who is the tallest as information about other persons is not given except Diksha.

So, this option will get eliminated individually.

II. As per this statement we can conclude this:

Elvish > Akansha > Diksha

Now from this statement we cannot conclude who is the tallest

So this option will get eliminated individually

Now, we will combine these two statements and we can conclude this:

Elvish > Akansha > Diksha > Banya/Caryl > Banya/Caryl

Now from this statement, we can conclude that Elvish is the tallest.

So, answer will be both the statement will be necessary to answer the question.

Answer: E

41) We will analyse both the statements separately.

I. As per this statement, we can conclude this:

$\xrightarrow{11 Top}$ Brijesh $\xleftarrow{16 Bottom}$ Akansha \xleftarrow{Caryl}

As per this statement, we can count the rank of Akansha that is 13th rank

II. From this statement it is not clear that where is Caryl in the class

So, this option will get eliminated individually

So, answer will be only I is sufficient to answer the question

Answer: A

42) We will analyse both the statements separately

I. As per this question we can conclude this:

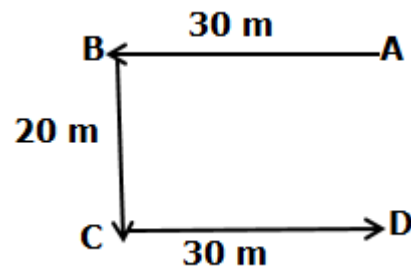

As per this statement, we can conclude that Rashi is facing East direction.

II. As per this statement we can conclude this:

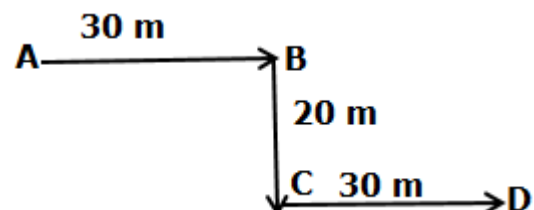

Ultra Practice Bundle PDF for All Bank Prelims Exams

As per this statement, we can conclude that Rashi is facing in East direction

So, answer will be we can any of the statements to answer the question

Answer: C

43) In this question we will analyse both the statements separately.

I. As per this statement, we can conclude that:

Taruna > Shivani > Rishabh

From this statement, we cannot conclude that who is the tallest as information about other persons is not mentioned

So, this option will get eliminated individually

II. As per this statement, we can conclude this:

Priyanka > Taruna > Queen

From this statement, we cannot conclude that who is the tallest as information about other persons is not mentioned

So, this option will get eliminated individually

Now, we will combine both these statements and we can conclude this:

Priyanka > Taruna > Shivani/Queen > Shivani/ Queen > Rishabh

From this statement, we can conclude that Priyanka is the tallest

So, answer will be both these statements are necessary to answer the question

Answer: E

44) We will take into consideration both the statements separately

I. As per this statement we can conclude this:

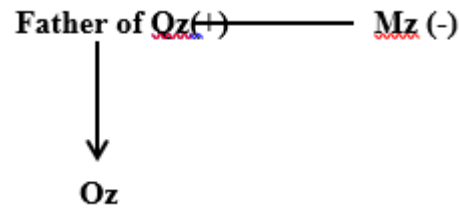

From this statement we cannot establish any relation between Kz and Mz

So, this option will get eliminated individually

II. As per this statement, we can conclude this:

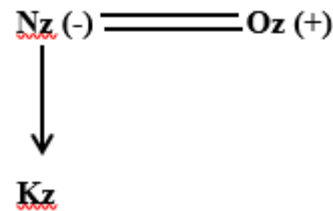

As per this family tree, we cannot conclude any relationship between Kz and Mz

So, this option will get eliminated individually

Now, we will combine both these statements and we cannot establish any common relationship between both the statements.

So, answer will be both the statements are not sufficient to answer the question

Answer: D

45) We will analyse both the statements separately

I. As per this statement we can conclude this:

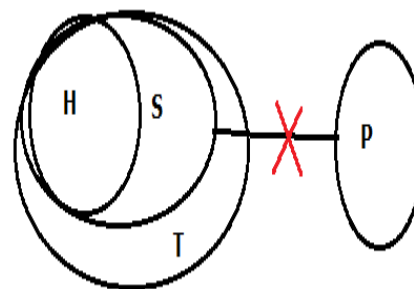

From this statement, we can say that All H are T

II. According to this statement we can conclude this:



Ultra Practice Bundle PDF for All Bank Prelims Exams

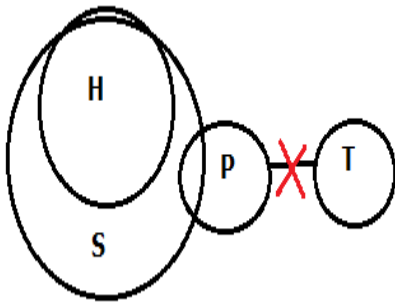

According to this statement, we cannot say that All H are T.

So, this statement will get eliminated individually

So, answer will be only I statement is sufficient to answer the question.

Answer: A

46) We will analyse both the statements separately

I. As per this statement, we can collude this:

Code for Money: ZX

From this statement, we can't derive the code for Systematic

So, this option will get eliminated individually

II. According to the second statement, we cannot derive the code for any word.

So, this option will get eliminated individually

Now, we will combine both these statements and we can conclude this:

Code for Money: ZX

Code for Systematic/Process: XM/NU

From, this also we can't get the code for Systematic

So, answer will be both the statements are not sufficient to answer the question

Answer: D

47) We will analyse both the statements separately.

I. As per this statement, we can conclude this:

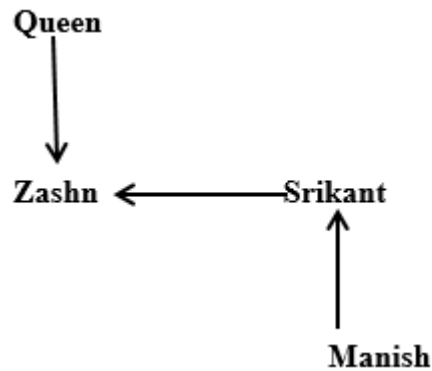

As per this statement, there is no information about Priyanshi

So, this statement will get eliminated individually

II. As per this statement, we can conclude this:

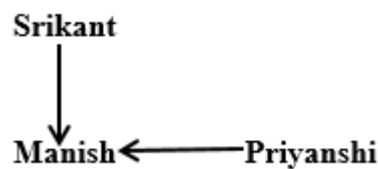

According to this statement, we don't have the information of Queen

So, this statement will get eliminated individually

Now, we will combine both these statements and we can conclude this:

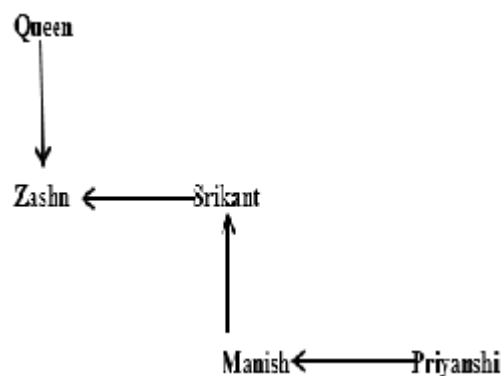

From this statement, we can conclude that Priyanshi is in South East direction from Queen.

So, answer will be both these statements are necessary to answer the question

Answer: E

48) We will analyse both the statements separately

I. According to this statement, we can conclude this:

Ultra Practice Bundle PDF for All Bank Prelims Exams

$$Mz = Rz \geq Sz > Tz \geq Kz \leq Lz$$

From this statement, we cannot draw any relation between Az and Mz

So, this statement will get eliminated individually.

II. According to this statement, we can conclude this:

$$Az = Bz < Tz = Nz > Fz = Gz$$

From this statement, we cannot draw any relation between Az and Mz

So, this statement will get eliminated individually.

Now we will combine both these statements and we can conclude this:

$$Az = Bz < Tz < Sz < Rz = Mz$$

From this statement we can conclude that Az is smaller than Mz

So, answer will be both these statements will be needed to answer the question

Answer: E

49) In this question we will solve each statement separately.

I) According to this statement, we can conclude this:

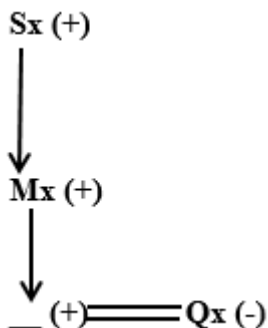

From this statement, we cannot conclude the relationship between Px and Mx

So, this statement will get eliminated individually.

II. We can conclude this from this statement:

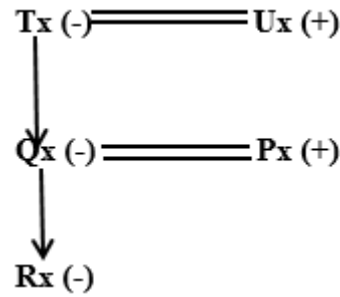

From this statement, we cannot conclude the relationship between Px and Mx

So, this statement will get eliminated individually.

Now we will combine both the statements and we can conclude this:

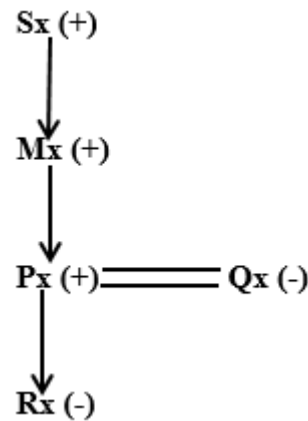

From this diagram, we can conclude that Px is grandson of Mx

So, answer will be both these statements are necessary to answer the question

Answer: E

50) We will analyse both the statements separately

I. According to this statement, we can conclude that:

$$Fz > Dz \text{ and } Cz > Az$$

$$Bz > Az$$

From this statement, we cannot conclude that who is the shortest

So, this statement will get eliminated individually.

II. As per this statement we can conclude that:

$$Ez > Fz > Bz \text{ and } Dz.$$

Ultra Practice Bundle PDF for All Bank Prelims Exams

From this statement, we cannot conclude that who is the shortest

So, this statement will get eliminated individually.

Now, we will combine both these statements and we can conclude that:

Ez > Fz >> Dz/Cz > Az/Bz

But from this statement we cannot conclude anything
So, answer will be both the statements are not sufficient to answer the question

Answer: D

15.Days Puzzle

Direction (1-5): Study the following information carefully and answer the questions given below:

Seven persons A, B, C, D, E, F and G work in seven different cities i.e. Patna, Palampur, Kochi, Bengaluru, Ranchi, Dehradun and Nagpur but not in the same order. They were born on seven different days from Monday to Sunday of the same week but again not in the same order.

A works in Kochi and was born on Tuesday. Only two persons born were between D and F but D was born on one of days before F. The one who works in Nagpur was born immediately after the one who works in Dehradun. The one who works in Bengaluru was born immediately before the one who works in Ranchi. C was born two days before the one who works in Patna. Both D and F were born on one of the days after the one who works in Kochi. Number of persons born between B and one who works in Palampur is same as the number of persons born between B and G. B was born one of the days before G. E works in Ranchi and was born on Friday.

1) Who among the following works in Dehradun?

- a. C
- b. F
- c. D
- d. G
- e. None of these

2) Who among the following was born three days before E?

- a. The one who works in Palampur
- b. The one who works in Bengaluru
- c. The one who works in Kochi
- d. The one who works in Ranchi
- e. None of these

3) Who among the following was born on Monday?

- a. The one who works in Patna
- b. The one who works in Ranchi
- c. The one who works in Bengaluru
- d. The one who works in Palampur
- e. None of these

4) ___ was born on Thursday and works in ___?

- a. B, Bengaluru
- b. C, Dehradun
- c. D, Bengaluru
- d. E, Ranchi
- e. None of these

Ultra Practice Bundle PDF for All Bank Prelims Exams

5) Four of the following five are related to each other in some way and thus formed a group. Choose the one which does not belong to that group.

- a. C - Tuesday
- b. D – Bengaluru
- c. G – Nagpur
- d. E – Wednesday
- e. B – Saturday

Direction (6-10): Study the following information carefully and answer the questions given below.

Seven people L, M, N, O, P, Q and R belong to seven different city/state Chennai, Bihar, Delhi, Odisha, Bengal, UP and Punjab. As they belong to different backgrounds they believe in different gods and they offer their respect by keeping fast for their respective gods on different days of a week from Monday to Sunday.

O keeps his fast three days after the person who belongs to UP but two days before N. M belongs to either Delhi or UP. R does not belong to Delhi. L keep his fast two days after M but two days before Q, who belongs to Bihar. The person who belongs to Bengal keeps his fast three days after P. The persons who belong to Chennai and Odisha keep their fast on the first and the last day of the week. R keeps his fast four days before N.

6) Who belongs to Delhi?

- a. M
- b. L
- c. P
- d. O
- e. None of the above

7) Who keeps his fast on Thursday?

- a. M

- b. O
- c. L
- d. N
- e. Q

8) The person who belongs to Odisha keeps his fast on which day of the week?

- a. Monday
- b. Tuesday
- c. Friday
- d. Saturday
- e. Can't be determined

9) R belongs to which state?

- a. Delhi
- b. Punjab
- c. Odisha
- d. UP
- e. Chennai

10) The person who keeps his fast on the second day of the week belongs to which state?

- a. UP
- b. Delhi
- c. Odisha
- d. Punjab
- e. Bihar

Direction (11-15): Study the following information carefully and answer the questions given below.

Seven persons Abhay, Bob, Cherry, Diana, Eva, Faizal and Geet attended music classes in seven days from

Ultra Practice Bundle PDF for All Bank Prelims Exams

Sunday to Saturday of a week but not in the same order.
One person attended classes only for one day.

Bob attends the classes after Eva. Number of persons attends the classes between Diana and Eva is one less than the number of persons attends between Diana and Bob. Only one person attends classes between Abhay and Cherry, but Cherry does not attend the classes on Sunday. Number of persons attending classes before Diana is equal to the number of persons attending classes after Geet. Bob attends classes immediately before Faizal. Abhay attends classes before Wednesday, but Abhay does not attend on Sunday. Faizal attends classes after Diana.

11) Who attends the classes on Sunday?

- a. Cherry
- b. Geet
- c. Eva
- d. Bob
- e. None of these

12) How many persons attend classes between Bob and Diana?

- a. Two
- b. Three
- c. Four
- d. Five
- e. None of these

13) Who attends the classes immediately before Cherry?

- a. Eva
- b. Geet
- c. Bob

- d. Diana
- e. Faizal

14) Which of the following statement is true?

- a. Geet attends the classes on Monday
- b. Cherry attends the classes immediately after Faizal
- c. Faizal attends the classes on Thursday
- d. Abhay attends the classes before Eva
- e. Only one person attends the classes between Bob and Cherry

15) Number of persons, who attend the classes before Cherry is one more than the number of persons attend the classes after_____.

- a. Eva
- b. Diana
- c. Geet
- d. Faizal
- e. Bob

Direction (16-20): Study the following information carefully and answer the questions given below.

Seven persons P, Q, R, S, T, U and V go to different cities among Nagpur, Pune, Mumbai, Delhi, Bangalore, Chennai and Lucknow but not necessarily in same order. Each of them goes for different days from 1 to 7.

T goes to Lucknow for 5 days. R goes for 2 more days than that of S. V goes to Nagpur. U goes for 1 day. Neither S nor U goes to Delhi. The one, who goes to Chennai, goes for twice number of days than that of V. Q does not go to Chennai. P does not go for 7 or 2 days. The one, who goes to Bangalore, goes for more days than that of R. V goes for odd number of days.

16) Who goes for 3 days?

Ultra Practice Bundle PDF for All Bank Prelims Exams

- a. P
- b. S
- c. T
- d. V
- e. None of these

17) To which city does S go?

- a. Mumbai
- b. Pune
- c. Chennai
- d. Bangalore
- e. Cannot be determined

18) Who goes for maximum number of days?

- a. P
- b. Q
- c. U
- d. V
- e. None of these

19) Who goes to Chennai?

- a. P
- b. Q
- c. V
- d. U
- e. None of these

20) Who goes for 2 days?

- a. R
- b. T

- c. S
- d. P
- e. None of these

Direction (21-25): Study the following information carefully and answer the questions given below.

Seven friends P, Q, R, S, T, U and V attend different language classes, namely French, English, Spanish, Sanskrit, Chinese, German and Japanese, but not in the same order from Monday to Sunday in a week.

P attends a class on Friday. Only two friends attend the class between P and the one who is learning Sanskrit. U attends the class immediately before S. Neither U nor S is learning Sanskrit. Only one person attends a class between U and the one who is learning Spanish. The one who is learning Spanish does not have a class on Monday. Q attends the class immediately before the one who is learning French. P is not learning French. Only one person has a class between U and T, where T is above U. R is learning German. Only two persons have classes between R and the one who is learning Chinese. T is not learning Japanese.

21) Who attends the class on Tuesday?

- a. T
- b. The one who is learning Japanese
- c. Q
- d. The one who is learning German
- e. None of the above

22) Who learns Japanese?

- a. V
- b. P
- c. S
- d. Q

Ultra Practice Bundle PDF for All Bank Prelims Exams

e. None of the above

23) How many persons learn the languages between the one who learns Spanish and T?

- a. One
- b. Four
- c. Two
- d. Three
- e. None of the above

24) ___ attends the class immediately before U.

- a. P
- b. The one who learns Sanskrit
- c. V
- d. The one who learns German
- e. None of the above

25) Who attends the class two days after the one who learns French?

- a. The one who learns Japanese
- b. The one who learns Chinese
- c. The one who learns English
- d. The one who learns German
- e. The one who learns Spanish

Direction (26-30): Read the following information carefully and answer the questions that follow.

There are seven friends A, B, C, D, E, F and G who visit an eye doctor every week. However, each one goes on a different day of the week, starting from Monday. No two persons go to the doctor on the same day.

A visits the doctor on Monday. D's turn to visit the doctor comes at the very last. Only four persons visit the doctor before C. G visits the doctor after C. B's turn comes after E but before F.

26) Who visits the doctor on Tuesday?

- a. A
- b. B
- c. C
- d. D
- e. E

27) Who visits the doctor on Saturday?

- a. E
- b. F
- c. G
- d. D
- e. B

28) On which day does F visit the doctor?

- a. Monday
- b. Tuesday
- c. Wednesday
- d. Thursday
- e. Friday

29) On which day does B visit the doctor?

- a. Monday
- b. Tuesday
- c. Wednesday
- d. Thursday

Ultra Practice Bundle PDF for All Bank Prelims Exams

e. Friday

30) How many persons visit the doctor before E?

- a. 1
- b. 2
- c. 3
- d. 4
- e. 5

Directions (31-35): Study the following information and answer the given below questions.

Seven lectures are scheduled to be held in a week. There is only one lecture on each of the seven days of the week, starting from Monday to Sunday. Chemistry is taught either on Wednesday or on Saturday.

Three lectures are scheduled between Chemistry and English in that order. Two lectures are scheduled to be held between English and Computers. Lecture on Physics is scheduled on the day which is immediately next to the day when lecture on Biology is scheduled. Lecture on Psychology is scheduled to be held after Mathematics. Lecture on Psychology is not scheduled on Saturday or Sunday.

31) Which of the following lectures is scheduled for Thursday?

- a. English
- b. Mathematics
- c. Biology
- d. Computers
- e. Physics

32) On which of the following days is the lecture on Psychology scheduled?

- a. Friday

b. Monday

c. Tuesday

d. Thursday

e. Sunday

33) Which of the following combinations of day – lecture is correct?

- a. Saturday – Physics
- b. Monday – Biology
- c. Tuesday – English
- d. Thursday – English
- e. Sunday – Computers

34) Which of the following lectures is scheduled for Sunday?

- a. Mathematics
- b. English
- c. Biology
- d. Physics
- e. None of these

35) On which of the following days is the lecture on Chemistry scheduled?

- a. Monday
- b. Sunday
- c. Saturday
- d. Wednesday
- e. Thursday

Direction (36-40): Study the following information carefully and answer the questions given below it.

Ultra Practice Bundle PDF for All Bank Prelims Exams

There are seven friends A, B, C, D, E, F and G. Each one goes on a trip on different days from Monday to Sunday but not necessarily in the same order.

C travels on the day after the day B travels. G travels on the day just before the day on which E travels. The number of persons between the one who travels on Wednesday and B is the same as the number of persons between D and G. F travels on Wednesday. E travels on the day which is 4 days after the day on which D travels. D doesn't travel on the day after the day on which F travels.

36) Who goes on Sunday?

- a. B
- b. A
- c. G
- d. C
- e. None of these

37) On which day D travels?

- a. Tuesday
- b. Friday
- c. Sunday
- d. Monday
- e. None of these

38) How many persons go after G?

- a. One
- b. Two
- c. Three
- d. Four
- e. More than four

39) Who does go on Tuesday?

- a. G
- b. A
- c. C
- d. D
- e. None of these

40) How many persons goes between C and the one who goes on Thursday?

- a. Three
- b. One
- c. Two
- d. Four
- e. More than four

Direction (41-45): Study the following information carefully and answer the questions given below it.

Seven persons P, Q, R, S, T, U and V moved to different cities on different days of a week from Monday to Sunday. Each of them moved to the cities among Delhi, Nagpur, Bengaluru, Goa, Mumbai, Chennai and Patna.

P does not move to Goa. Two persons moved between the persons, who moved to Mumbai and Delhi. Q moved to Patna just after S, who does not move on Friday or Tuesday. T moves to Nagpur three days after the person, who moved to Goa. V moved to Bengaluru on Sunday. R moves before S's moving day. U moved after Q but not to Mumbai. R does not move to Mumbai or Goa.

41) Who moved to Chennai?

- a. P
- b. R
- c. S
- d. T

Ultra Practice Bundle PDF for All Bank Prelims Exams

e. Cannot be determined

42) How many persons moved before the moving day of U?

- a. Three
- b. Four
- c. Five
- d. One
- e. None of these

43) S moved to _____.

- a. Chennai
- b. Patna
- c. Nagpur
- d. Goa
- e. None of these

44) How many persons moved after the one, who moved to Patna?

- a. Two
- b. Three
- c. Four
- d. One
- e. None of these

45) S moved on _____.

- a. Monday
- b. Wednesday
- c. Saturday
- d. Sunday
- e. Tuesday

Direction (46-50): Study the following information carefully and answer the questions given below it.

Seven persons Pari, Quan, Rinku, Samraat, Tarun, Utkarsh and Vijay have meetings on different days of a week from Monday to Sunday.

At least two persons have meeting before the meeting day of Rinku. Utkarsh has meeting two days after Quam but not on Thursday or Wednesday. Three persons have meeting between the meeting day of Rinku and Samraat. Rinku does not have meeting on Sunday. Quam does not have meeting on Friday. Vijay has meeting just before Pari but not on Tuesday.

46) Who among the following has meeting on Saturday?

- a. Utkarsh
- b. Samraat
- c. Rinku
- d. Pari
- e. None of these

47) How many persons have meeting before Tarun's meeting?

- a. Five
- b. Three
- c. Four
- d. One
- e. None of these

48) Quam has meeting on _____.

- a. Tuesday
- b. Saturday
- c. Wednesday

Ultra Practice Bundle PDF for All Bank Prelims Exams

d. Thursday

e. None of these

49) Who among the following has meeting on Monday?

a. Pari

b. Vijay

c. Quam

d. Utkarsh

e. None of these

50) How many persons have meeting between Pari's and Samraat's meeting?

a. Three

b. Five

c. Four

d. One

e. None of these

Answer and Explanations:

Solutions 1-5

1. A works in Kochi and was born on Tuesday. Only two persons born between D and F but D was born on one of days before F.

2. Both D and F were born one of the days after the one who works in Kochi. E works in Ranchi and was born on Friday.

3. The one who works in Bengaluru was born immediately before the one who works in Ranchi.

Case I: When D was born on Wednesday:

Day	Person	City
Monday		
Tuesday	A	Kochi
Wednesday	D	
Thursday		Bengaluru
Friday	E	Ranchi
Saturday	F	
Sunday		

Case II: When D was born on Thursday:

Day	Person	City
Monday		
Tuesday	A	Kochi
Wednesday		
Thursday	D	Bengaluru
Friday	E	Ranchi
Saturday		
Sunday	F	

4. The one who works in Nagpur was born immediately after the one who works in Dehradun.

5. C was born two days before the one who works in Patna.

Case I: When D was born on Wednesday:

Day	Person	City
Monday	C	
Tuesday	A	Kochi
Wednesday	D	Patna
Thursday		Bengaluru

Ultra Practice Bundle PDF for All Bank Prelims Exams

Friday	E	Ranchi
Saturday	F	Dehradun
Sunday		Nagpur

Case II: When D was born on Thursday:

Day	Person	City
Monday	C	
Tuesday	A	Kochi
Wednesday		Patna
Thursday	D	Bengaluru
Friday	E	Ranchi
Saturday		Dehradun
Sunday	F	Nagpur

6. Number of persons born between B and one who works in Palampur is same as the number of persons born between B and G.

7. B was born on one of the days before G, which is not possible in case II, so case II is invalid.

The final arrangement is as follows:

Day	Person	City
Monday	C	Palampur
Tuesday	A	Kochi
Wednesday	D	Patna
Thursday	B	Bengaluru
Friday	E	Ranchi
Saturday	F	Dehradun
Sunday	G	Nagpur

Answers:

- b
- c
- d
- a

5. c

Solutions 6-10

1) L keep his fast two days after M but two days before Q, who belongs to Bihar.

(Implies Q keeps his fast 4 days after M, hence there are three possibilities here which are, M keeps his fast either on Monday, Tuesday or Wednesday.)

2) The persons who belong to Chennai and Odisha keep their fast either on the first or the last day of the week.

3) M belongs to either Delhi or UP.

(It clearly implies M does not keep his fast on Monday as he is neither from Chennai nor Odisha, also Q does not keep his fast on Sunday because he is from Bihar and not from Chennai or Odisha (Which means M can't be having his fast on Wednesday as Q can't have his fast on Sunday). Implies M fast on Tuesday, L on Thursday and Q on Saturday.)

Monday	Person	City/State
Monday		Chennai/Odisha
Tuesday	M	Delhi/UP
Wednesday		
Thursday	L	
Friday		
Saturday	Q	Bihar
Sunday		Chennai/Odisha

4) O keeps his fast three days after the person who belongs to UP but two days before N.

(Let us suppose that M is from Delhi and the person who keep his fast on Wednesday of from UP, then O would be having his fast on Saturday and two days before N, which is not possible as Saturday is the second last day of the week. Hence our assumption was wrong, the person from UP can't have fast on Wednesday or any other day after Wednesday. Implies M is from UP and O keeps his fast on Friday and N keeps his fast two days after that, i.e. on Sunday.)

Monday	Person	City/State
--------	--------	------------



Ultra Practice Bundle PDF for All Bank Prelims Exams

Monday		Chennai/Odisha
Tuesday	M	UP
Wednesday		
Thursday	L	
Friday	O	
Saturday	Q	Bihar
Sunday	N	Chennai/Odisha

5) R keeps his fast four days before N.

(It's clear that N keeps his fast on Sunday, implies R keeps his fast on Wednesday.)

6) The person who belongs to Bengal keeps his fast three days after P.

(There is only one place left for P to be placed that is on Monday, implies L belongs to Bengal and keeps his fast on Thursday.)

7) R does not belong to Delhi.

(As there are only two options for R and Delhi is one of them, implies the other option is the answer, i.e. Punjab. Also as Delhi is left to be mapped, we can say O belongs to Delhi as O is the only person left to be mapped to a state).

Monday	Person	City/State
Monday	P	Chennai/Odisha
Tuesday	M	UP
Wednesday	R	Punjab
Thursday	L	Bengal
Friday	O	Delhi
Saturday	Q	Bihar
Sunday	N	Chennai/Odisha

Answers:

6. d

7. c

8. e

9. b

10. a

Solutions 11-15

1. Abhay attends classes before Wednesday, but Abhay does not attend on Sunday, which means Abhay attends either on Monday or Tuesday.

2. Only one person attends classes between Abhay and Cherry.

Case I:

Day	persons
Sunday	
Monday	Abhay
Tuesday	
Wednesday	Cherry
Thursday	
Friday	
Saturday	

Case II:

Day	Person
Sunday	
Monday	
Tuesday	Abhay
Wednesday	
Thursday	Cherry
Friday	
Saturday	

3. Number of persons attend classes before Diana is equal to the number of persons attend classes after Geet.

4. Bob attends classes immediately before Faizal.

5. Bob attends the classes after Eva.

6. Number of persons attend between Diana and Eva is one less than the number of persons attend between Diana and Bob. This is not possible in case II.



Ultra Practice Bundle PDF for All Bank Prelims Exams

So, the final arrangement is as follows.

Day	Person
Sunday	Eva
Monday	Abhay
Tuesday	Diana
Wednesday	Cherry
Thursday	Geet
Friday	Bob
Saturday	Faizal

Answers:

- 11. c
- 12. a
- 13. d
- 14. e
- 15. c

Solutions 16-20

1. T goes Lucknow for 5 days.
2. R goes for 2 more days than that of S.
3. V goes to Nagpur. U goes for 1 day.
4. The one, who goes to Chennai, goes for twice number of days than that of V.
5. V goes for odd number of days.

$$i.e. V=3 \text{ and Chennai}=6 (2*3=6)$$

$$R=2+S$$

$$(Case-1, S=2 \text{ and } R=4)$$

$$(Case-2, S=4 \text{ and } R=6)$$

So, we have two cases,

Case 1:.

Persons	Cities	Days
P		

Q		
R		4
S		2
T	Lucknow	5
U		1
V	Nagpur	3

Case 2:

Persons	Cities	Days
P		
Q		
R	Chennai	6
S		4
T	Lucknow	5
U		1
V	Nagpur	3

5. Q does not go to Chennai. P does not go for 7 or 2 days. So, case 2 is rejected.

7. The one, who goes to Bangalore, goes for more days than that of R.

8. Neither S nor U goes to Delhi. So, we have,

Persons	Cities	Days
P	Chennai	6
Q	Bangalore	7
R	Delhi	4
S	Mumbai/Pune	2
T	Lucknow	5
U	Pune/Mumbai	1
V	Nagpur	3

Answers:

- 16. d
- 17. e

Ultra Practice Bundle PDF for All Bank Prelims Exams

18. b

19. a

20. c

Solutions 21-25

1. Only two friends attend the class between P and the one who is learning Sanskrit.

2. U attends the class immediately before S.

3. Neither U nor S is learning Sanskrit. Only one person attends a class between U and the one who is learning Spanish.

4. Only one person has a class between U and T.

So, U attends immediately before S which means U either attends on Wednesday or Saturday.

Case I:

Days	Persons	Languages
Monday	T	
Tuesday		Sanskrit
Wednesday	U	
Thursday	S	
Friday	P	Spanish
Saturday		
Sunday		

Case II:

Days	Persons	Languages
Monday		
Tuesday		Sanskrit
Wednesday		
Thursday	T	Spanish
Friday	P	
Saturday	U	
Sunday	S	

5. R is learning German. Only two persons have classes between R and the one who is learning Chinese.

6. T is not learning Japanese.

7. Q attends immediately before the one who is learning French.

So, in case II Q must attend the class on Tuesday which means R attends on Monday but then we can't fix the one who is learning Chinese which means case II is invalid.

Now, in case I Q must attend on Tuesday which means R attends on Sunday so, that the one who learns Chinese can attend the class on Thursday.

The final arrangement is as follows:

Days	Persons	Languages
Monday	T	English
Tuesday	Q	Sanskrit
Wednesday	U	French
Thursday	S	Chinese
Friday	P	Spanish
Saturday	V	Japanese
Sunday	R	German

Answers:

21. c

22. a

23. d

24. b

25. e

Solutions 26-30

1) A visits the doctor on Monday.

2) D's turn to visit the doctor comes at the very last.

(Thus D visits the doctor on Sunday)

Day	Person



Ultra Practice Bundle PDF for All Bank Prelims Exams

Monday	A
Tuesday	
Wednesday	
Thursday	
Friday	
Saturday	
Sunday	D

3) Only four persons visit the doctor before C.

Day	Person
Monday	A
Tuesday	
Wednesday	
Thursday	
Friday	C
Saturday	
Sunday	D

4) G visits the doctor after C.

(Since, D visits the doctor at last on Sunday, thus G must visit the doctor on Saturday)

Day	Person
Monday	A
Tuesday	
Wednesday	
Thursday	
Friday	C
Saturday	G
Sunday	D

5) B's turn comes after E but before F.

Day	Person
Monday	A

Tuesday	E
Wednesday	B
Thursday	F
Friday	C
Saturday	G
Sunday	D

Answers:

26. e

27. c

28. d

29. c

30. a

Solutions 31-35

1) Chemistry is taught either on Wednesday or on Saturday. Three lectures are scheduled between Chemistry and English in that order.

Therefore, Chemistry is taught on Wednesday and English is taught on Sunday.

Day	Lecture
Monday	
Tuesday	
Wednesday	Chemistry
Thursday	
Friday	
Saturday	
Sunday	English

2) Two lectures are scheduled to be held between English and Computers.

So, Computers is taught on Thursday.

Day	Lecture
Monday	

Ultra Practice Bundle PDF for All Bank Prelims Exams

Tuesday	
Wednesday	Chemistry
Thursday	Computers
Friday	
Saturday	
Sunday	English

3) Lecture on Physics is scheduled on the day which is immediately next to the day when lecture on Biology is scheduled.

Case i)

Day	Lecture
Monday	Biology
Tuesday	Physics
Wednesday	Chemistry
Thursday	Computers
Friday	
Saturday	
Sunday	English

Case ii)

Day	Lecture
Monday	
Tuesday	
Wednesday	Chemistry
Thursday	Computers
Friday	Biology
Saturday	Physics
Sunday	English

4) Lecture on Psychology is scheduled to be held after Mathematics.

Case i)

Day	Lecture

Monday	Biology
Tuesday	Physics
Wednesday	Chemistry
Thursday	Computers
Friday	Mathematics
Saturday	Psychology
Sunday	English

Case ii)

Day	Lecture
Monday	Mathematics
Tuesday	Psychology
Wednesday	Chemistry
Thursday	Computers
Friday	Biology
Saturday	Physics
Sunday	English

5) Lecture on Psychology is not scheduled on Saturday or Sunday.

The above condition is not satisfied in case i.

Therefore, the final arrangement will be as shown below:

Day	Lecture
Monday	Mathematics
Tuesday	Psychology
Wednesday	Chemistry
Thursday	Computers
Friday	Biology
Saturday	Physics
Sunday	English

Answers:

31. d

32. c

Ultra Practice Bundle PDF for All Bank Prelims Exams

33. a

34. b

35. d

Solutions 36-40

- 1) F travels on Wednesday.
- 2) D doesn't travel on the day after the day on which F travels.

Case 1:

Day	Person
Monday	D
Tuesday	
Wednesday	F
Thursday	
Friday	
Saturday	
Sunday	

Case 2:

Day	Person
Monday	
Tuesday	D
Wednesday	F
Thursday	
Friday	
Saturday	
Sunday	

- 3) E travels on the day which is 4 days after the day on which D travels.
- 4) The number of persons between the one who travels on Wednesday and B is the same as the number of persons between D and G.
- 5) G travels on the day just before the day on which E travels.

Case 1:

Day	Person
Monday	D
Tuesday	
Wednesday	F
Thursday	G
Friday	E
Saturday	B
Sunday	

Case 2:

Day	Person
Monday	
Tuesday	D
Wednesday	F
Thursday	
Friday	G
Saturday	E
Sunday	

C goes on Sunday.

Using statement 5, Case 2 will be eliminated as there is a gap of 2 days between D and G. F travels on Wednesday. So, B will travel on Saturday. But E travels on Saturday.

- 6) C travels on the day after the day B travels.

Day	Person
Monday	D
Tuesday	A
Wednesday	F
Thursday	G
Friday	E
Saturday	B
Sunday	C

Answers:

Ultra Practice Bundle PDF for All Bank Prelims Exams

36. d

37. d

38. c

39. b

40. c

Solutions 41-45

1. T move to Nagpur three days after the person, who moved to Goa.
2. Q moved to Patna just after S, who does not move on Friday or Tuesday.
3. R moves before S's moving day.

So there will be two cases

	Case 1		Case 2	
Days of a Week	Persons	Cities	Persons	Cities
Monday				
Tuesday		Goa		
Wednesday	S		S	Goa
Thursday	Q	Patna	Q	Patna
Friday	T			
Saturday			T	
Sunday	V	Bengaluru	V	Bengaluru

4. Two persons moved between the persons, who moved to Mumbai and Delhi.
5. U moved after Q but not to Mumbai.
6. R does not move to Mumbai or Goa.
7. P does not move to Goa.

Days of a Week	Persons	Cities
Monday	R	Chennai
Tuesday	P	Mumbai

Wednesday	S	Goa
Thursday	Q	Patna
Friday	U	Delhi
Saturday	T	Nagpur
Sunday	V	Bengaluru

Answers:

41. b

42. b

43. d

44. b

45. b

Solutions 46-50

1. At least two persons have meeting before the meeting day of Rinku.
2. Three persons have meeting between the meeting day of Rinku and Samraat.
3. Rinku does not have meeting on Sunday.

	Case 1	Case 2	Case 3
Days	Persons	Persons	Persons
Monday		Samraat	
Tuesday			Samraat
Wednesday	Rinku		
Thursday			
Friday		Rinku	
Saturday			Rinku
Sunday	Samraat		

4. Quam does not have meeting on Friday.



Ultra Practice Bundle PDF for All Bank Prelims Exams

5. Utkarsh have meeting two days after Quam but not on Thursday or Wednesday.

	Case 1	Case 2	Case 3
Days	Persons	Persons	Persons
Monday		Samraat	
Tuesday			Samraat
Wednesday	Rinku		Quam
Thursday	Quam	Quam	
Friday		Rinku	Utkarsh
Saturday	Utkarsh	Utkarsh	Rinku
Sunday	Samraat		

6. Vijay has meeting just before Pari but not on Tuesday.

So, Case 2 and case 3 are rejected.

Days	Persons

Monday	Vijay
Tuesday	Pari
Wednesday	Rinku
Thursday	Quam
Friday	Tarun
Saturday	Utkarsh
Sunday	Samraat

Answers:

46. a

47. c

48. d

49. b

50. c

18. Certain Number- Circle

Directions (1-5): Study the following information carefully and answer the questions given below:

Certain numbers of persons are sitting around a circular table. All the persons are facing towards the centre. There are two person sit between U and T. Either O or S is neighbour of U. Q sits third to the right of P. S is 3rd to the left of T. V is immediate right to W. X sits to the immediate left of Y. Z sits second to right of S. Z sit next to N. The number of persons sitting between Q and R is same as between P and Q. O and P is sitting next to each other. There is only two person sit between V and Y. V

sits third to the right of U. The number of persons sitting between N and T is same as between O and T.

1. What is the position of N with respect to U?

- (a) Fifth to left
- (b) Immediate right
- (c) Immediate left
- (d) Second to right
- (e) None of these

Ultra Practice Bundle PDF for All Bank Prelims Exams

2. How many persons are sitting in the circular table?

- (a) Twelve
- (b) Fourteen
- (c) Nine
- (d) Thirteen
- (e) None of these

3. Who is sitting seventh to the right of Z?

- (a) N
- (b) R
- (c) Y
- (d) W
- (e) None of these

4. What is the position of P with respect to Z?

- (a) Second to the left
- (b) Third to the left
- (c) Second to the right
- (d) Fourth to the right
- (e) None of these

5. W is an immediate neighbour of which of the following?

- (a) U
- (b) Q
- (c) Both (b) and (d)
- (d) V
- (e) Cannot be determined

Directions (6-10): Study the following information carefully and answer the questions given below:

A certain number of people are sitting around a circle facing the center. At most one person is sitting between D and B. One person is sitting between C and E. A sits to the immediate left of B. Six people are sitting between B and E. Five people are sitting between C and D. Three people are sitting between C, who is not an immediate neighbour of F and A. E sits third to the right of F. D is not an immediate neighbour of B.

6. How many persons are sitting in the circular table?

- (a) Ten
- (b) Fifteen
- (c) Thirteen
- (d) Nine
- (e) Twelve

7. Who among the following is sitting at a gap of three seats from A?

- (I) C
- (II) F
- (III) E

- (a) Only I
- (b) Only III
- (c) Only II and III
- (d) Only I and II
- (e) Only II

8. What is the position of A with respect to C?

- (a) Immediate left
- (b) Fourth to the right
- (c) Immediate right
- (d) Fourth to the left
- (e) None of these

Ultra Practice Bundle PDF for All Bank Prelims Exams

9. How many persons sit between E and A?

- (I) Five
- (II) Seven
- (III) Six

- (a) Only I
- (b) Only III
- (c) Only I and III
- (d) Only I and II
- (e) Only II

10. Which of the following statement is false?

- (a) D sits fourth to the right of A.
- (b) F sits third to left of E.
- (c) B sits fourth to right of C.
- (d) F sits immediate right D.
- (e) None of these

Directions (11-15): Study the following information carefully and answer the questions given below:

Certain number of persons sits around a circular table facing the center. Only four persons are sit between P and T, who is on the immediate left of Q. S is sixth to the right of U. R is at a gap of two persons from U, who is adjacent to T. Only one person sits between R and V. V sits fifth to the right of Q. V sits on the immediate left of P.

11. How many people are sitting in the circular table?

- (a) Nine
- (b) Eleven
- (c) Twelve
- (d) Ten
- (e) Cannot be determine

Q12. How many known people are sitting between S and U, when counted from left of S?

- (a) Three
- (b) One
- (c) Two
- (d) Four
- (e) Five

13. What is the position of R with respect to Q?

- (a) Third to the left
- (b) Third to the right
- (c) Fifth to the left
- (d) Ninth to the right
- (e) Eight to right

14. Who amongst the followings is third to the right of P?

- (a) R
- (b) S
- (c) T
- (d) Q
- (e) Cannot be determined

15. How many people can sit between T and V?

- (a) Three
- (b) Five
- (c) Two
- (d) Four
- (e) One

Ultra Practice Bundle PDF for All Bank Prelims Exams

Directions (16-20): Study the following information carefully and answer the questions given below:

A certain number of persons are sitting around a circular table facing towards the center. Only six persons sit between E and B. G is not an immediate neighbor of E. G sits fourth to the left of B. B is an immediate neighbor of C. Only three persons sit between A and C. There are five persons sit between E and D from the left of E. F sits second to the left of E. Only three persons sit between C and E. Not more than four persons sit between G and F from left of F. Only three persons sit between A and C.

16. Who is sitting second to the right of A?

- (a) F
- (b) B
- (c) D
- (d) E
- (e) Cannot be determined

17. Who sits at immediate right of E?

- (a) P
- (b) U
- (c) O
- (d) D
- (e) Cannot be determined

18. How many persons sitting in a circle?

- (a) Seven
- (b) Nine
- (c) Eleven
- (d) Ten
- (e) None of these

19. Who among the following person sits sixth to the right of F?

- (a) A
- (b) D
- (c) B
- (d) E
- (e) None of these

20. How many persons are sitting between C and G, when counting right of C?

- (a) Two
- (b) One
- (c) Five
- (d) Four
- (e) More than five

Directions (21-25): Study the following information carefully and answer the questions given below:

A certain number of persons are sitting around a circular table facing towards the center. D sits second to the right B. G sits fourth to the right of F. There are two person sits between A and H. D sits third to the left of E. F sits seventh to the right of B. C sits immediate right of F. Only three people sit between A and B. Only four people sit between B and C. C is not an immediate neighbor of A.

21. How many people are sitting in the circular table?

- (a) Nine
- (b) Eleven
- (c) Twelve
- (d) Thirteen
- (e) Cannot be determine

Ultra Practice Bundle PDF for All Bank Prelims Exams

22. How many people are sitting between F and B, when counted from left of F?

- (a) Three
- (b) One
- (c) Two
- (d) Five
- (e) More than five

23. What is the position of H with respect to D?

- (a) Third to the left
- (b) Immediate to the left
- (c) Fifth to the left
- (d) Seventh to the right
- (e) Eight to right

24. If M sits immediate left of A then who sits fourth to the left of M?

- (a) B
- (b) E
- (c) D
- (d) F
- (e) Cannot be determined

25. How many people can sit between H and G from left of H?

- (a) Three
- (b) Five
- (c) Two
- (d) Four
- (e) One

Directions (26-30): Study the following information carefully and answer the questions given below:

A certain number of persons are sitting around a circular table facing towards the center. Q is to the immediate left of B. H is sitting fifth to the right of B. D sits second to the left of Q. D is not an immediate neighbor of H. Only three persons are sitting between D and H. P is sitting fifth to the right of M, who is an immediate neighbor of Q. Only seven persons are sitting between Y and M from left of M. Z sits fourth to the right of P.

26. How many persons are sitting in the circular table?

- (a) Ten
- (b) Fifteen
- (c) Thirteen
- (d) Nine
- (e) Twelve

27. Who among the following is sitting at a gap of three seats from P?

- (I) Z
- (II) Q
- (III) D

- (a) Only I
- (b) Only III
- (c) Only II and III
- (d) Only I and II
- (e) Only II

28. What is the position of Y with respect to D?

- (a) Immediate left
- (b) Fourth to the right
- (c) Fifth to the right

Ultra Practice Bundle PDF for All Bank Prelims Exams

- (d) Fourth to the left
- (e) None of these

29. How many persons sit between Z and Y?

- (I) Four
- (II) Seven
- (III) Six

- (a) Only I
- (b) Only III
- (c) Either I or III
- (d) Either I or II
- (e) Only II

30. Which of the following statement is false?

- (a) Y sits fifth to the right of D.
- (b) Z sits third to left of M.
- (c) B sits fourth to right of Z.
- (d) P sits immediate right Y.
- (e) None of these

Directions (31-35): Study the following information carefully and answer the questions given below:

A certain number of persons are sitting around a circular table facing towards the center. J is sitting fifth to the left of K. There is three seats between K and L. There is five persons sit between M and O. J is an immediate neighbor of P. K sits fourth to the right of P. There is three seats between J and M. M is an immediate neighbor of L. N sits fourth to the right of O. Not more than 13 people and not less than 10 sit in the circular table.

31. If B sits third to the right of J, then what is the position of L with respect to J?

- (a) Second to the left

- (b) Immediate right
- (c) Immediate left
- (d) Sixth to the right
- (e) None of these

32. How many persons are sitting in the circular table?

- (a) Twelve
- (b) Fourteen
- (c) Nine
- (d) Thirteen
- (e) None of these

33. Who is sitting seventh to the right of P?

- (a) J
- (b) O
- (c) M
- (d) N
- (e) None of these

34. What is the position of K with respect to M?

- (a) Second to the left
- (b) Third to the left
- (c) Second to the right
- (d) Fourth to the right
- (e) None of these

35. P is an immediate neighbour of which of the following?

- (a) J
- (b) O

Ultra Practice Bundle PDF for All Bank Prelims Exams

(c) Both (a) and (b)

(d) L

(e)

Directions (36-40): Study the following information carefully and answer the questions given below:

A certain number of persons are sitting around a circular table facing towards the center. More than ten persons sit in this circular table. E sits next to D but not an immediate neighbor of H. There are four seats between F and H. There are six persons sit between A and H. H sits fifth to the left of G. A sits third to the left of F. B sits at a gap of three seats from G. H is not an immediate neighbor of B. C sits second to the left of H. Three persons sit between C and D.

36. Who is sitting second to the right of D?

(a) F

(b) B

(c) D

(d) E

(e) Cannot be determined

37. Who is sitting second to the left of A?

(a) G

(b) B

(c) C

(d) D

(e) Cannot be determined

38. How many persons sitting in a circle?

(a) Seventeen

(b) Nineteen

(c) Eleven

(d) Fifteen

(e) None of these

39. Who among the following person sits sixth to the right of E?

(a) A

(b) D

(c) B

(d) C

(e) None of these

40. How many persons are sitting between B and D, when counting right of D?

(a) Two

(b) Six

(c) Five

(d) Four

(e) Three

Directions (41-45): Study the following information carefully and answer the questions given below:

A certain number of persons are sitting around a circular table facing towards the center. There are two persons sit between A and G. There is only one person sit between G and D. There is only person between B and C who does not sit next to D. F sits third to the right of G. A is an immediate neighbor of B. D sits third to the left of B.

41. What is the position of D with respect to F?

(a) Fifth to left

(b) Immediate right

(c) Immediate left

Ultra Practice Bundle PDF for All Bank Prelims Exams

- (d) Second to right
- (e) None of these

42. How many persons are sitting in the circular table?

- (a) Twelve
- (b) Fourteen
- (c) Nine
- (d) Thirteen
- (e) None of these

43. Who is sitting sixth to the right of B?

- (a) D
- (b) F
- (c) A
- (d) G
- (e) None of these

44. What is the position of G with respect to A?

- (a) Second to the left
- (b) Third to the right
- (c) Second to the right
- (d) Fourth to the right
- (e) None of these

45. A is an immediate neighbour of which of the following?

- (a) B
- (b) C
- (c) Both (a) and (b)
- (d) D

- (e) Cannot be determined

Directions (46-50): Study the following information carefully and answer the questions given below:

A certain number of persons are sitting around a circular table facing towards the center. There are more than eight persons sit in the circular table. D sits second to the left of A. C sits third to the left of G. G sits fourth to the left of D. C sits fourth to the right of E. H sits second to the left of D. There are two person sits between H and B, who is an immediate neighbor of G. F sits at a gap of three seats from left of B. There are two persons sit between A and B.

46. Who is sitting second to the right of C?

- (a) F
- (b) B
- (c) A
- (d) E
- (e) Cannot be determined

47. Who sits at immediate right of G?

- (a) P
- (b) U
- (c) O
- (d) D
- (e) Cannot be determined

48. How many persons sitting in a circle?

- (a) Seven
- (b) Nine
- (c) Eleven
- (d) Ten
- (e) None of these

Ultra Practice Bundle PDF for All Bank Prelims Exams

49. Who among the following person sits fifth to the right of F?

- (a) A
- (b) G
- (c) B
- (d) E
- (e) None of these

50. How many persons are sitting between F and G, when counting right of F?

- (a) Two
- (b) One
- (c) Four
- (d) Five
- (e) More than five

Solution with Explanation

SOLUTION (1-5):

Explanation in detail:

1. S is 3rd to the left of T.
2. Two persons are sitting between U and T.
3. Either O or S is neighbour of U.

CASE1:

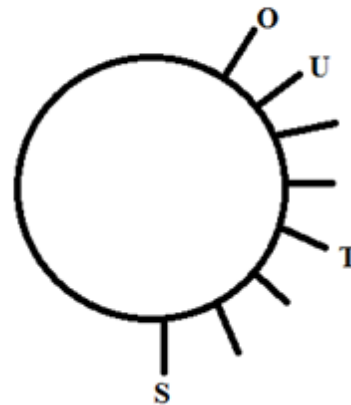

CASE2:

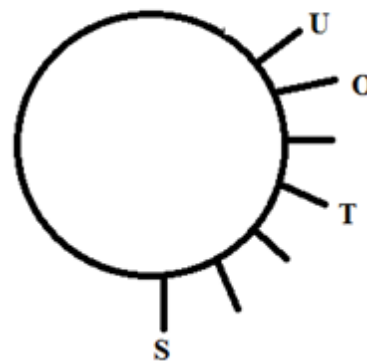

4. The number of persons sitting between N and T is same as between O and T.



Ultra Practice Bundle PDF for All Bank Prelims Exams

- 5. Z sits second to right of S.
- 6. Z sit next to N.

In CASE1 Z is not an immediate neighbor of N So, CASE1 is cancelled out.

CASE1:

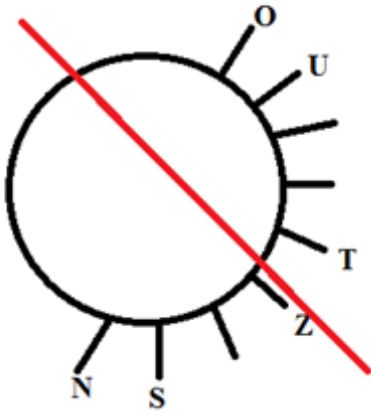

CASE2:

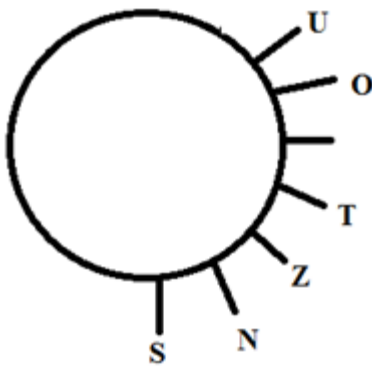

- 7. O and P is sitting next to each other.
- 8. X sits to the immediate left of Y.
- 9. Y sits second to left of N.

CASE2:

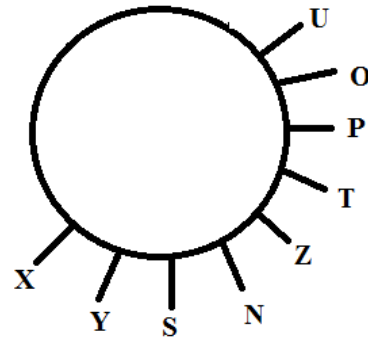

- 10. The number of persons sitting between Q and R is same as between P and Q.
- 11. Q sits third to the right of P.

CASE2:

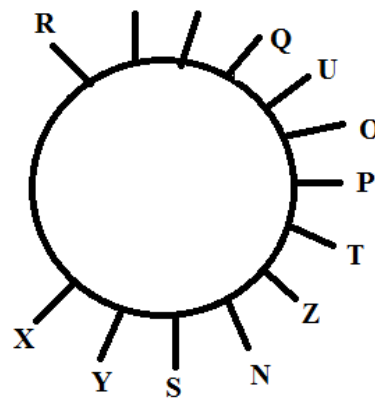

- 12. V sits third to the right of U.
- 13. V is immediate right to W.
- 14. There is only two person sit between V and Y.

Final arrangement:



Ultra Practice Bundle PDF for All Bank Prelims Exams

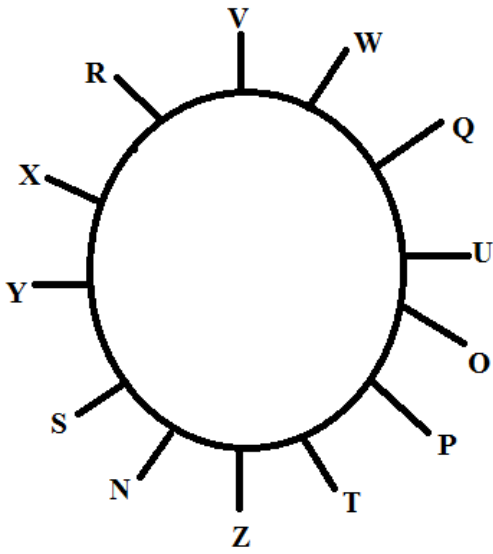

1. a
2. d
3. E (V is sitting 7th right of Z)
4. c
5. c

SOLUTION (6-10):

Explanation in detail:

1. E sits third to the right of F.
2. Six people are sitting between B and E.
3. A sits to the immediate left of B.

CASE1:

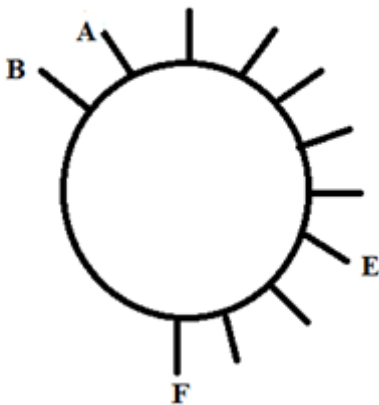

CASE2

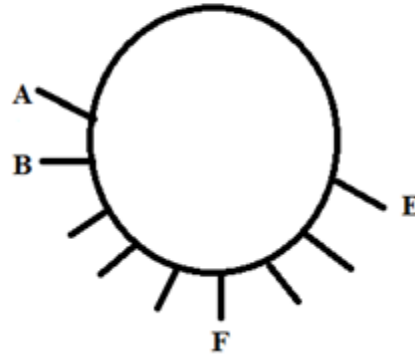

4. Three people are sitting between C, who is not an immediate neighbour of F and A.
5. One person is sitting between C and E.

CASE1:

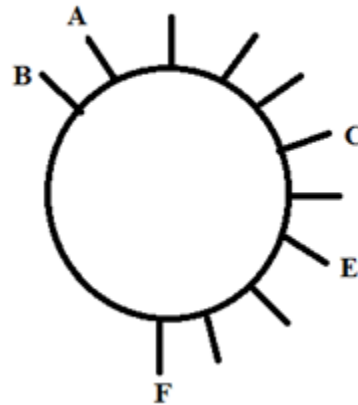

CASE2

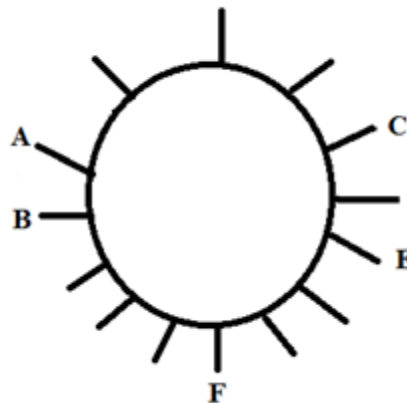

6. Five people are sitting between C and D.
7. D is not an immediate neighbour of B.



Ultra Practice Bundle PDF for All Bank Prelims Exams

8. One person is sitting between D and B.

CASE1:

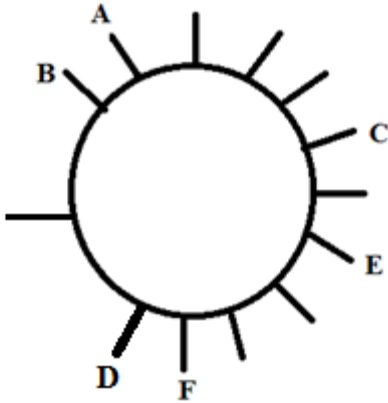

CASE2

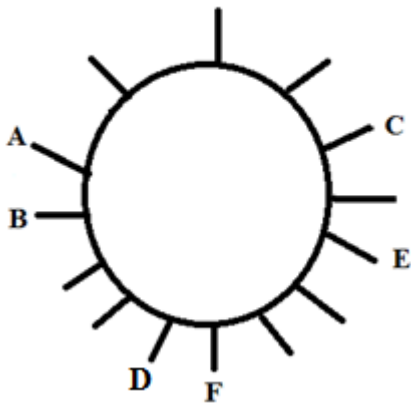

There is gap of two between B and D in CASE2 so CASE2 is cancelled out.

Final arrangement:

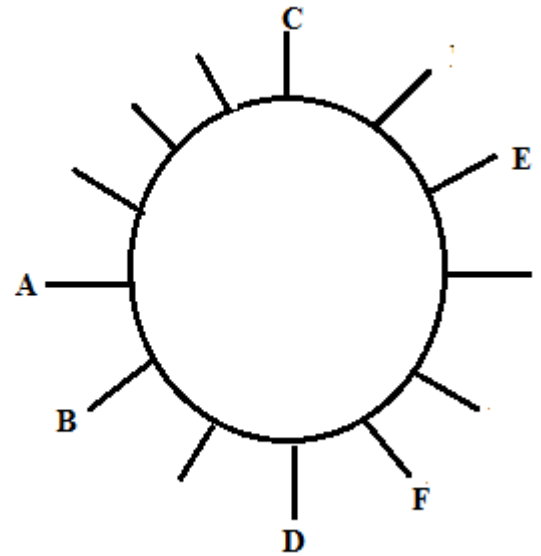

- 6. c
- 7. d
- 8. b
- 9. c
- 10. e [option a & c are False i.e. both a & c)

SOLUTION (11-15):

Explanation in detail:

- 1. Only four persons are sit between P and T
- 2. T is on the immediate left of Q.
- 3. U is adjacent to T.



Ultra Practice Bundle PDF for All Bank Prelims Exams

CASE1:

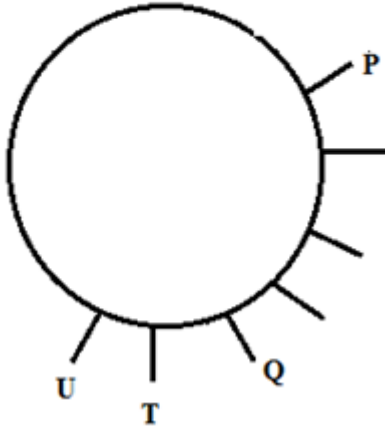

CASE1:

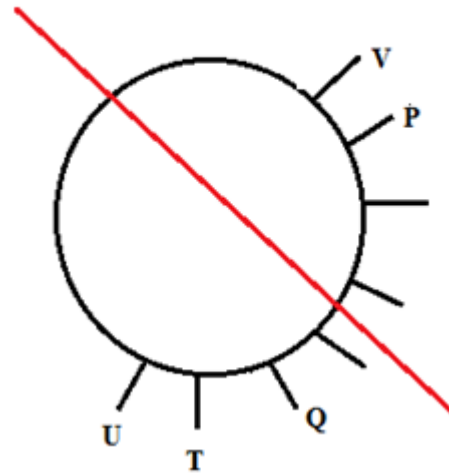

CASE2:

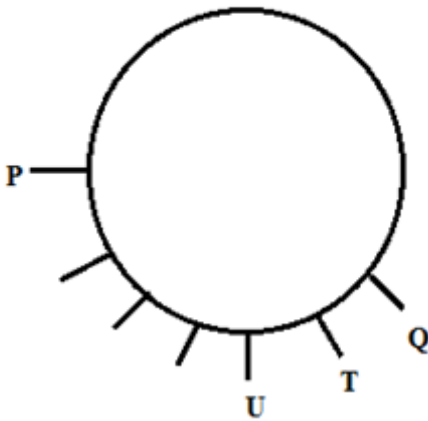

CASE2:

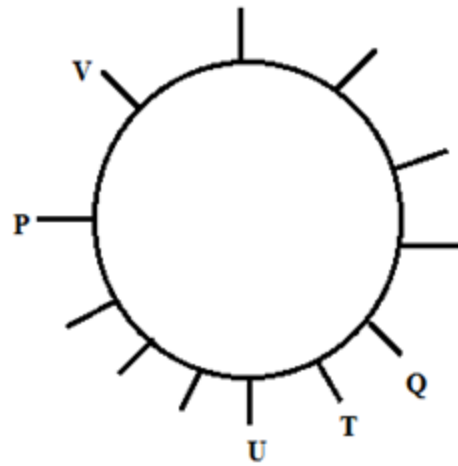

- 4. V sits fifth to the right of Q.
- 5. V sits on the immediate left of P.

- 6. S is sixth to the right of U.
- 7. R is at a gap of two persons from U.
- 8. Only one person sits between R and V.

In CASE1 V sits on the immediate right of P so CASE1 is cancelled out.



Ultra Practice Bundle PDF for All Bank Prelims Exams

CASE2:

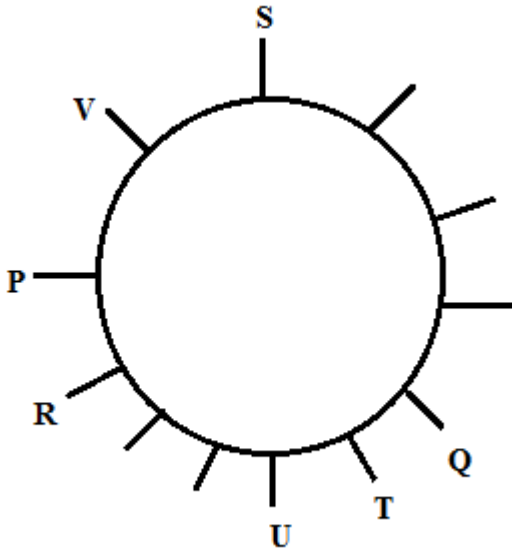

Final arrangement:

CASE2:

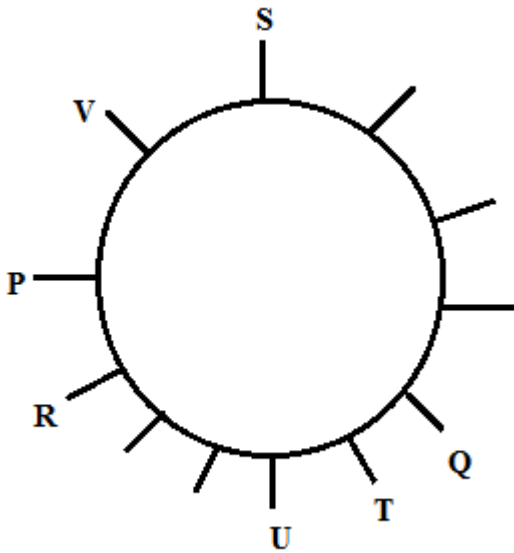

SOLUTION (16-20):

Explanation in detail:

1. G sits fourth to the left of B.
2. B is an immediate neighbor of C.

CASE1:

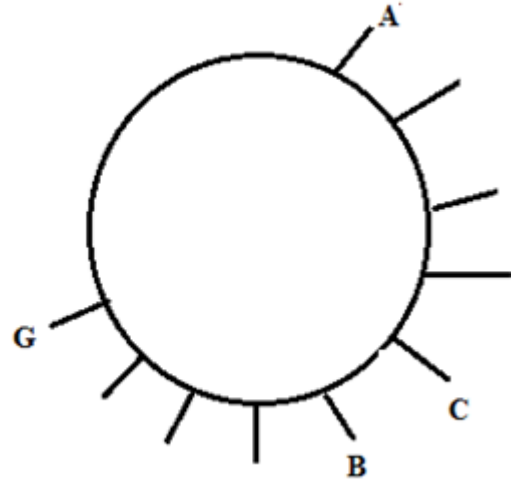

CASE2:

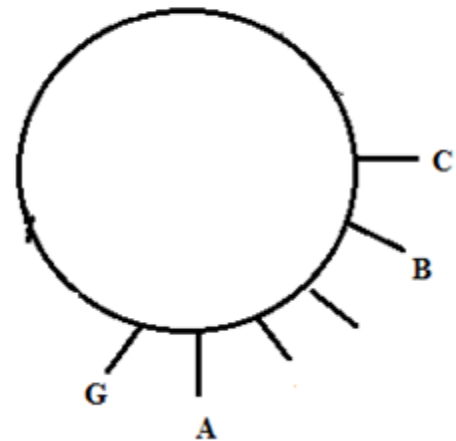

11. c
12. C
13. c
14. e
15. b



Ultra Practice Bundle PDF for All Bank Prelims Exams

CASE1a

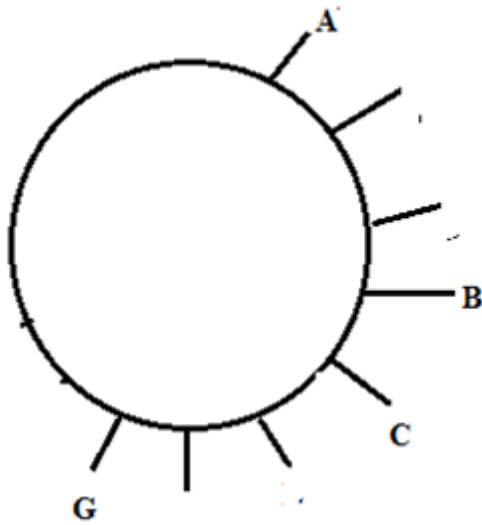

CASE2:

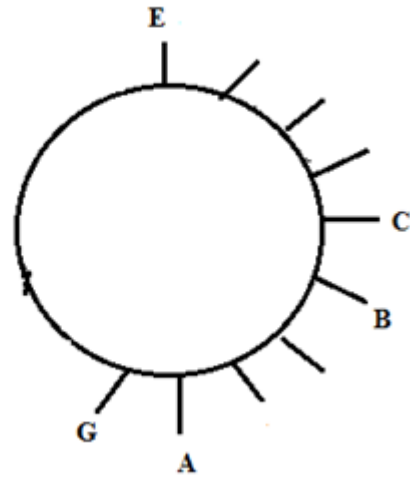

CASE2a

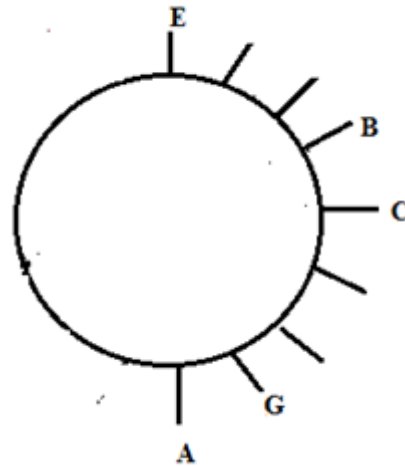

CASE2a

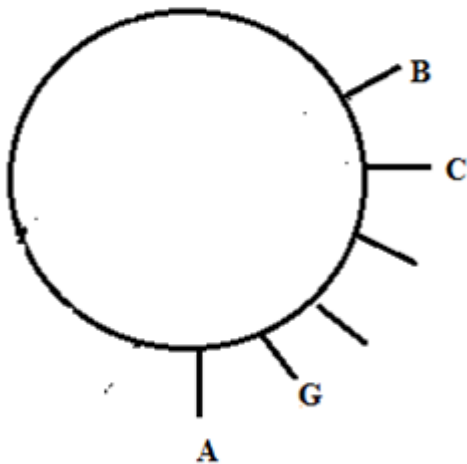

- 5. F sits second to the left of E.
- 6. Not more than four persons sit between G and F from left of F.

In CASE2 there is more than four persons sit between F and G So, CASE2 is cancelled out.

- 3. Only three persons sit between C and E.
- 4. G is not an immediate neighbor of E.

In CASE1 and CASE1a there is no such space for E so, CASE1 and CASE1a is cancelled out.



Ultra Practice Bundle PDF for All Bank Prelims Exams

CASE2a

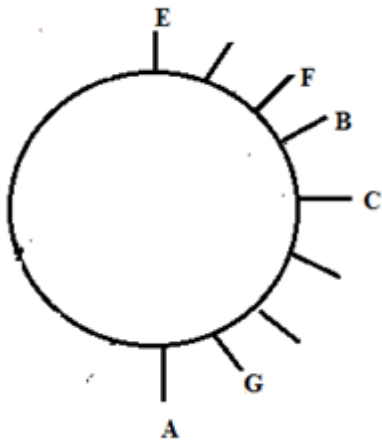

7. Only six persons sit between E and B from right of E.
8. There are five persons sit between E and D from the left of E.

CASE2a

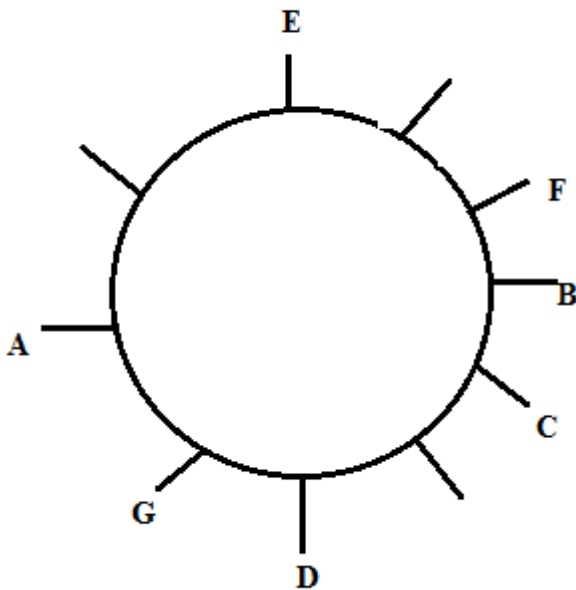

Final arrangement:

CASE2a

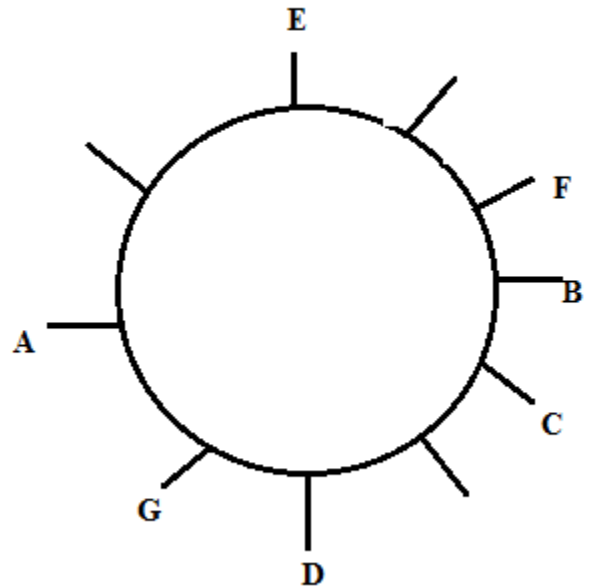

16. c
17. e
18. d
19. b
20. e

SOLUTION (21-25):

Explanation in detail:

1. Only three people sit between A and B.
2. Only four people sit between B and C.
3. C is not an immediate neighbor of A.



Ultra Practice Bundle PDF for All Bank Prelims Exams

CASE1:

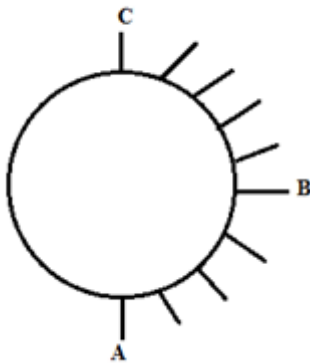

CASE2:

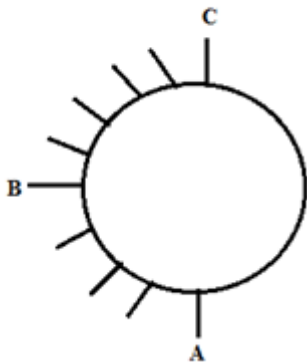

- 4. F sits seventh to the right of B.
- 5. C sits immediate right of F.

CASE1:

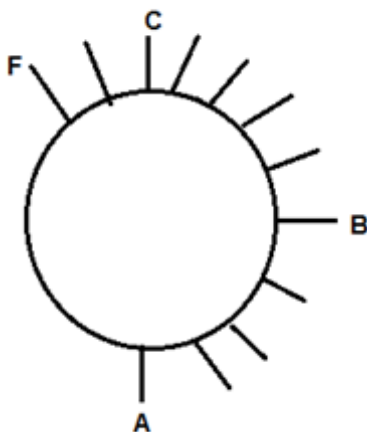

CASE2:

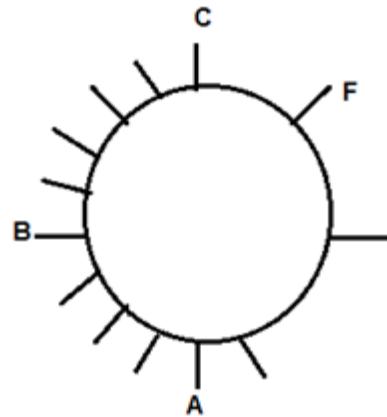

F sits second to right of C, so CASE1 is cancelled out.

- 6. D sits second to the right B.
- 7. G sits fourth to the right of F.
- 8. There are two persons sit between A and H.
- 9. D sits third to the left of E.

CASE2:

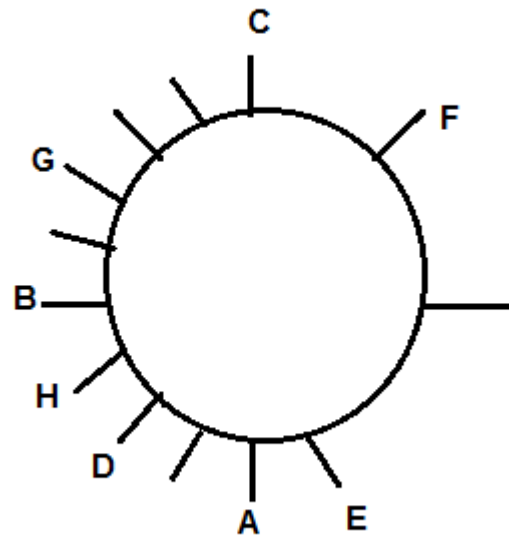

Final arrangement:



Ultra Practice Bundle PDF for All Bank Prelims Exams

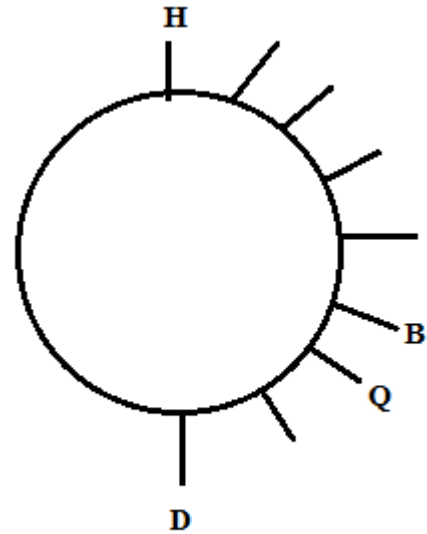
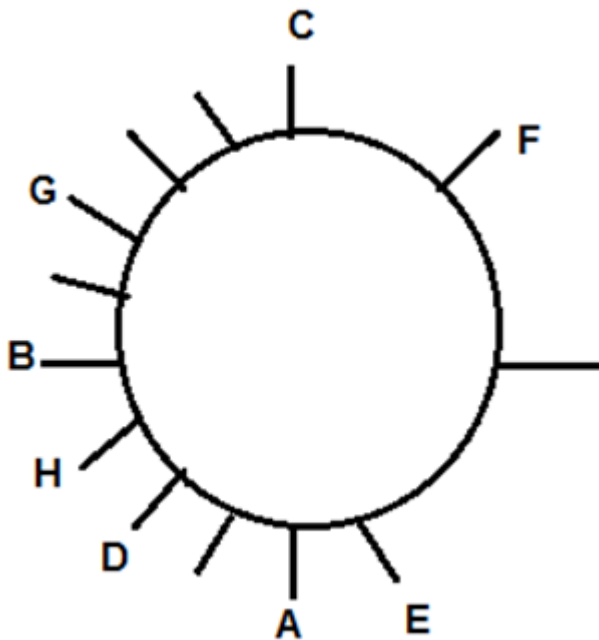

- 5. Only three persons are sitting between D and H.
- 6. P is sitting fifth to the right of M, who is an immediate neighbor of Q.

- 21. d
- 22. e
- 23. b
- 24. e
- 25. c

SOLUTION (26-30):

Explanation in detail:

- 1. Q is to the immediate left of B.
- 2. H is sitting fifth to the right of B.
- 3. D sits second to the left of Q.
- 4. D is not an immediate neighbor of H.

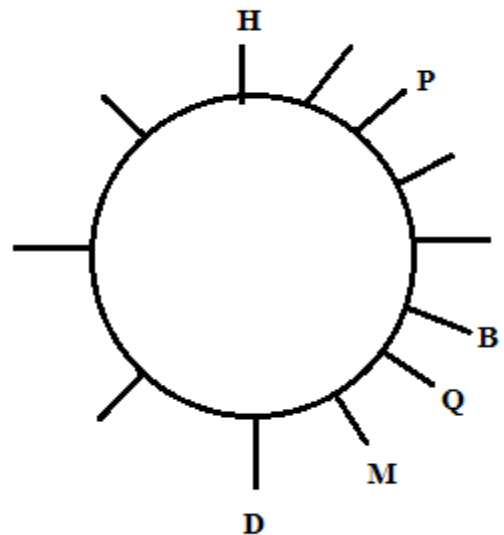

- 7. Only seven persons are sitting between Y and M from left of M.
- 8. Z sits fourth to the right of P.



Ultra Practice Bundle PDF for All Bank Prelims Exams

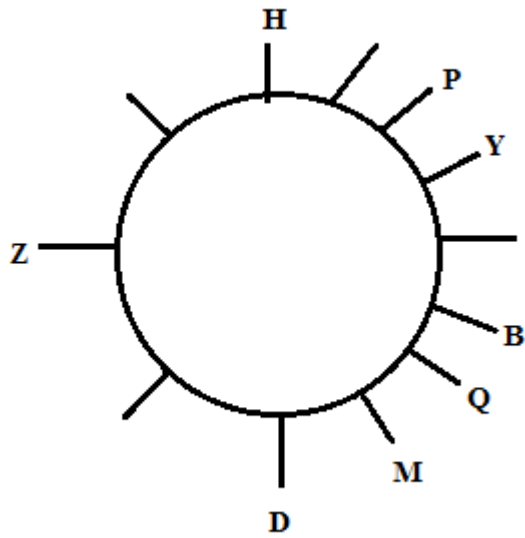

1. K sits fourth to the right of P.
2. There is three seats between K and L.

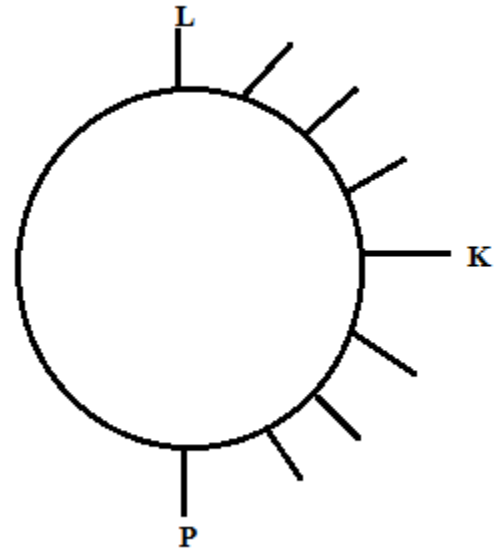

Final arrangement:

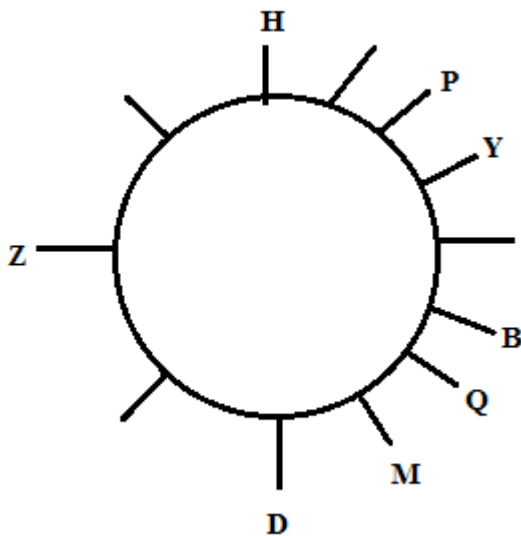

3. J is sitting fifth to the left of K.
4. J is an immediate neighbor of P.

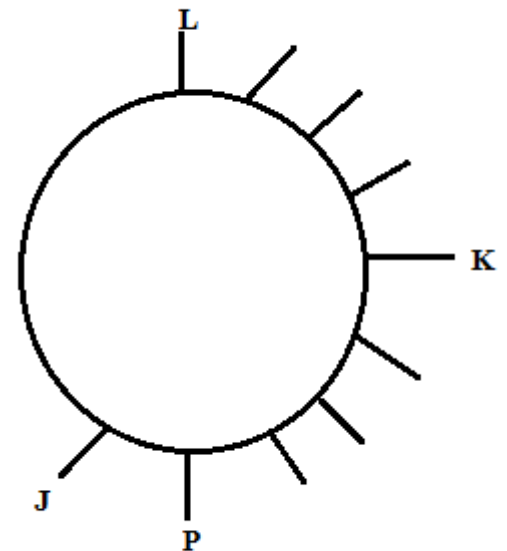

5. There is three seats between J and M.

- 26. e
- 27. d
- 28. c
- 29. c
- 30. c

SOLUTION (31-35):

Explanation in detail:



Ultra Practice Bundle PDF for All Bank Prelims Exams

6. M is an immediate neighbor of L.

NOTE: Not more than 13 people and not less than 10 sit in the circular table.

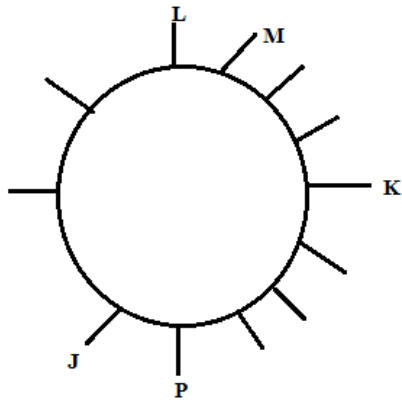

7. N sits fourth to the right of O.
8. There is five persons sit between M and O.

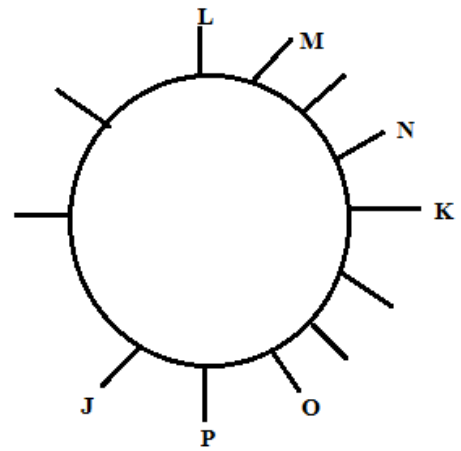

- 31. e
- 32. a
- 33. c
- 34. b
- 35. c

SOLUTION (36-40):

Explanation in detail:

- 1. A sit third to the left of F.
- 2. There are four seats between F and H.

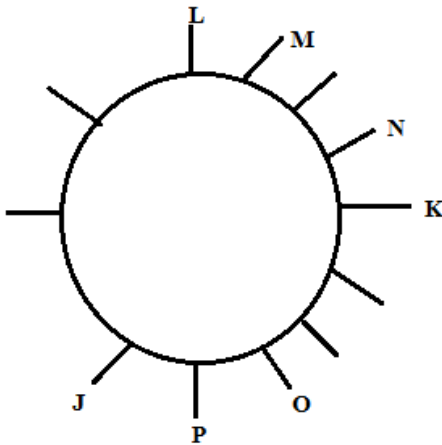

Final arrangement:



Ultra Practice Bundle PDF for All Bank Prelims Exams

CASE1:

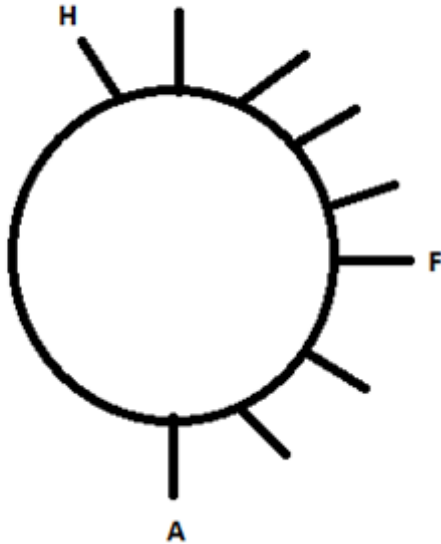

CASE1:

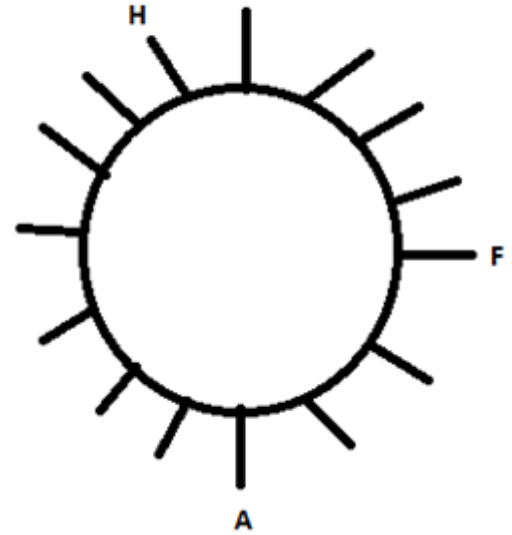

CASE2:

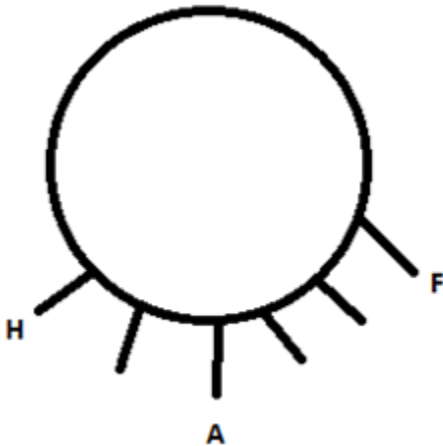

CASE2:

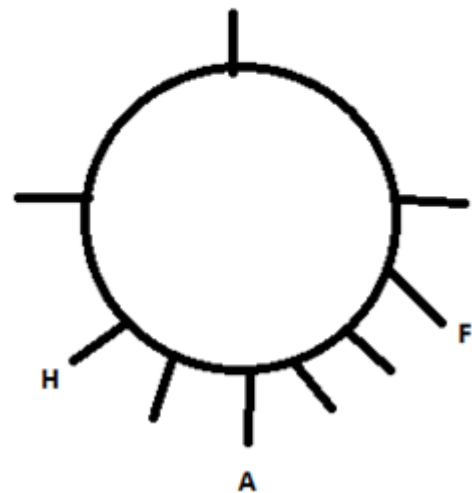

3. There are six persons sit between A and H.

**NOTE: More than persons it in this circular table.
So, CASE2 is cancelled out.**

4. H sits fifth to the left of G.
5. B sits at a gap of three seats from G.
6. H is not an immediate neighbor of B.



Ultra Practice Bundle PDF for All Bank Prelims Exams

CASE1:

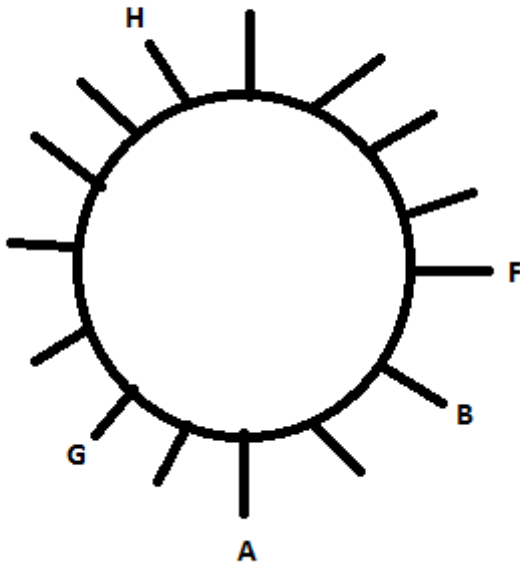

- 7. C sits second to the left of H.
- 8. Three persons sit between C and D.
- 9. E sits next to D but not an immediate neighbor of H.

CASE1:

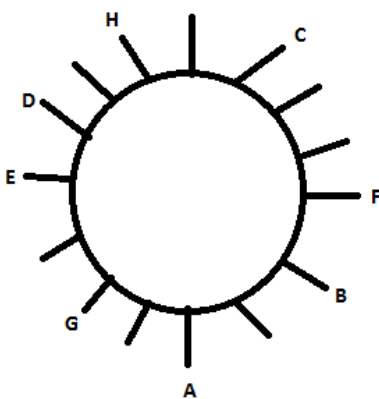

Final arrangement:

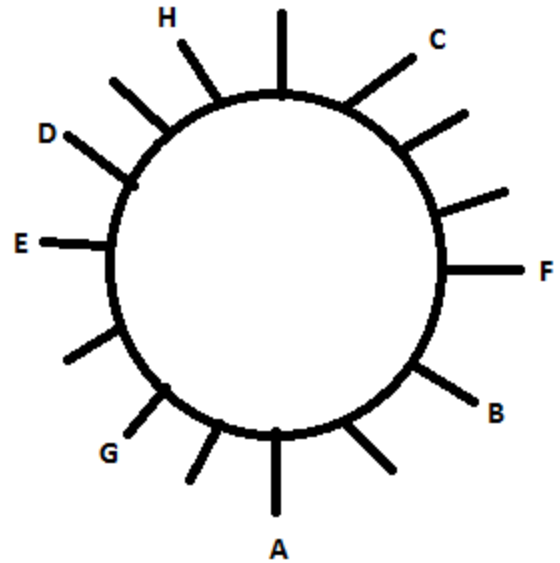

- 36. e
- 37. a
- 38. d
- 39. c
- 40. b

SOLUTION (41-45):

Explanation in detail:

- 1. A is an immediate neighbor of B.
- 2. D sits third to the left of B.

CASE1:

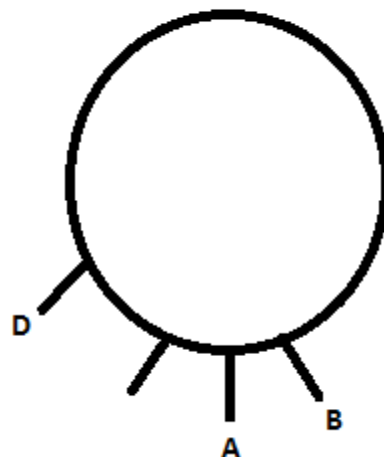



Ultra Practice Bundle PDF for All Bank Prelims Exams

CASE2:

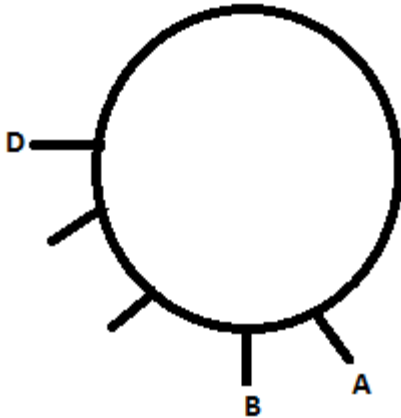

- 3. There are two persons sit between A and G.
- 4. G is not an immediate neighbor of D.

CASE1:

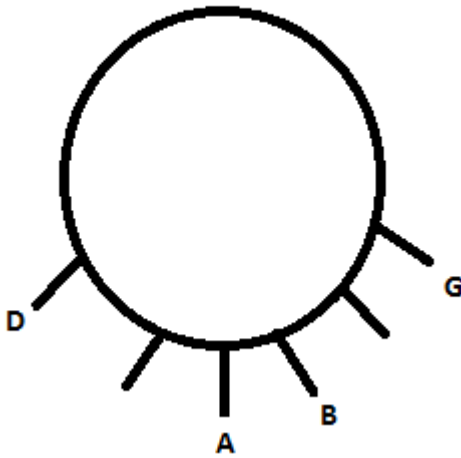

CASE2:

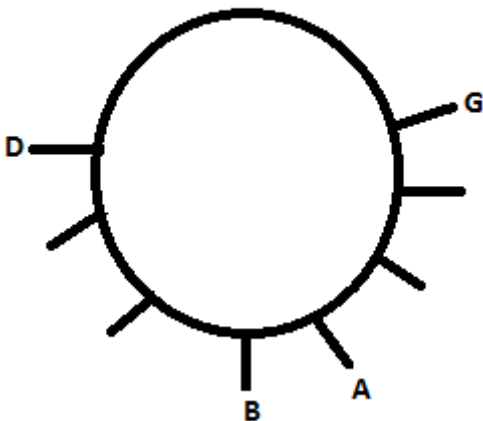

- 5. There is only one person sit between G and D.
- 6. There is only person between B and C who does not sit next to D.

In CASE1 C sits next to D so, CASE1 is cancelled out.

CASE2:

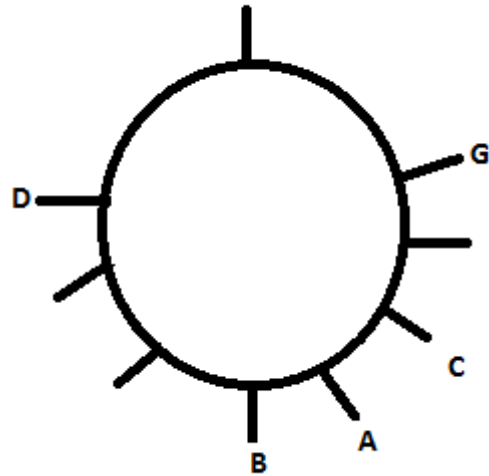

- 7. F sits third to the right of G.

CASE2:

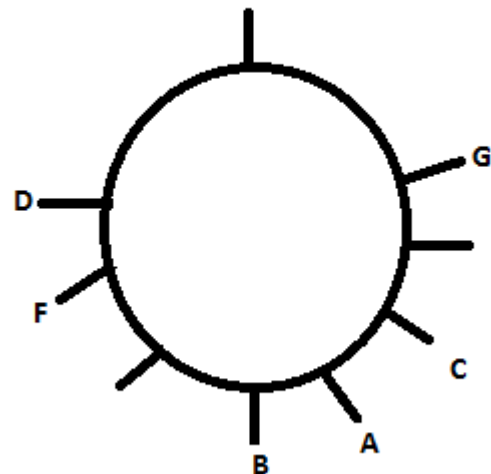

Final arrangement:



Ultra Practice Bundle PDF for All Bank Prelims Exams

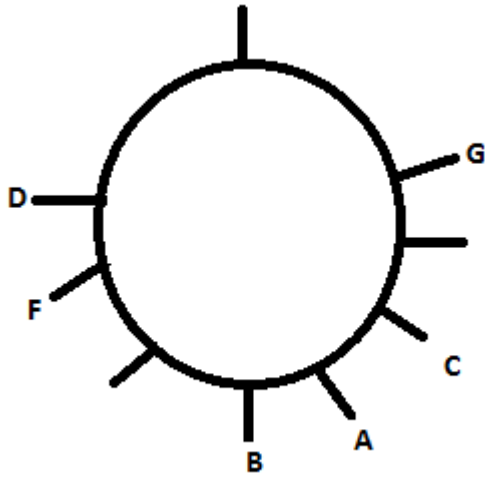

- 6. There are two persons sit between A and B.
- 7. There are more than eight persons sit in the circular table.

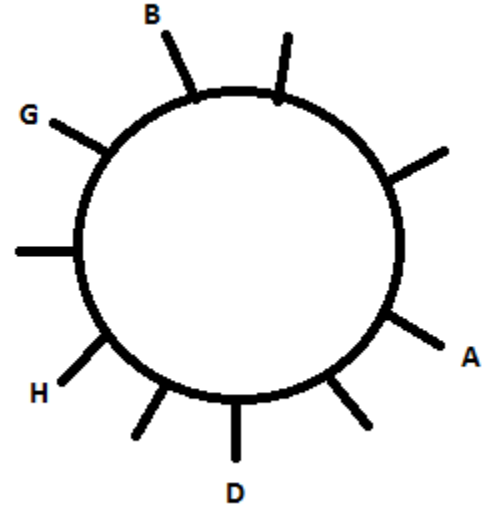

- 8. C sits fourth to the right of E.
- 9. C sits third to the left of G.
- 10. F sits at a gap of three seats from left of B.

- 41. c
- 42. c
- 43. a
- 44. b
- 45. c

SOLUTION (46-50):

Explanation in detail:

- 1. D sits second to the left of A.
- 2. H sits second to the left of D.

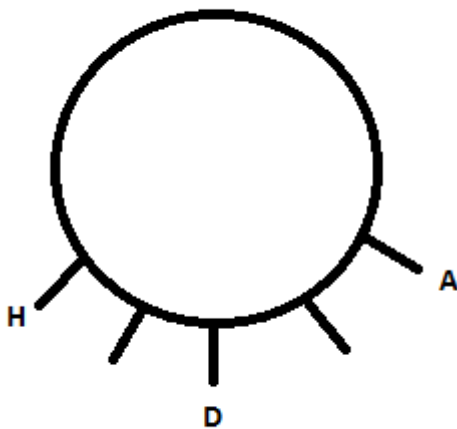

- 3. There are two persons sits between H and B,
- 4. B is an immediate neighbor of G.
- 5. G sits fourth to the left of D.

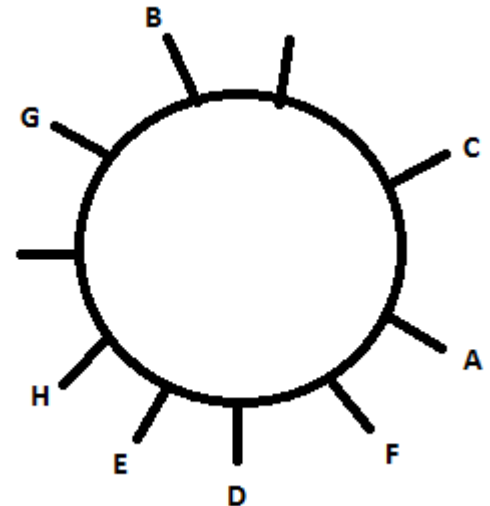

Final arrangement:

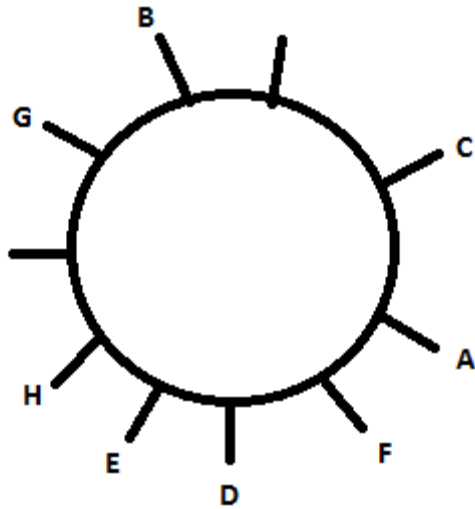

- 46. b
- 47. e
- 48. d
- 49. b
- 50. c

19. Floor Based Puzzle

Direction (1-5): Study the following information carefully and answer the question given below:

There are eight people A, B, C, D, E, F, G and H are living in a 8 floor Building on different floors from top to bottom (such as ground floor is numbered as 1 and top floor is numbered as 8) but not necessarily in the same order. There is a gap of three floors between B and D and both of them live on odd number of floors. F lives just above H who lives on an even numbered floor. A lives on floor number 6. Only one person lives between B and E. D lives above A. Three persons live between C and H.

Q1. Who lives on floor number five?

- (a) C
- (b) F
- (c) D
- (d) G
- (e) None of these

Q2. How many persons live between C and B?

- (a) One
- (b) Three
- (c) Five
- (d) Four
- (e) None of these

Q3. Who lives immediately above E?

- (a) G
- (b) A
- (c) D
- (d) H
- (e) None of these

Q4. Four of the following five are alike in a certain way based on the given arrangement and thus form a group. Which is the one that does not belong to that group?

- (a) C

Ultra Practice Bundle PDF for All Bank Prelims Exams

- (b) A
- (c) H
- (d) B
- (e) G

Q5. Who lives on 4TH floor?

- (a) D
- (b) B
- (c) E
- (d) F
- (e) None of these

Direction (6-10): Study the following information carefully and answer the question given below:

There are eight people A, B, C, D, E, F, G and H are living in a 8 floor Building on different floors from top to bottom (such as ground floor is numbered as 1 and top floor is numbered as 8) but not necessarily in the same order. F lives on an odd number floor but does not live on 3rd floor. H lives immediate below F. More than two persons live between G and H. There are six persons live between A and G. D lives immediate above E but live below B. C does not live above F. E does not live immediate above G.

Q6. Who among the following live on the odd floor?

I. F

II. B

III. C

- (a) Only I
- (b) Only II
- (c) Only I and III
- (d) Only I and II
- (e) Only III

Q7. Who among the following live immediate below C?

- (a) D
- (b) A
- (c) G
- (d) B
- (e) None of these

Q8. Four of the following five are alike in a certain way based on the given arrangement and thus form a group. Which is the one that does not belong to that group?

- (a) G
- (b) A
- (c) H
- (d) D
- (e) C

Q9. What is the difference between the floor number of A and H?

- (a) One
- (b) Three
- (c) Five
- (d) Two
- (e) None of these

Q10. Who lives immediately above F?

- (a) G
- (b) A
- (c) H
- (d) D

Ultra Practice Bundle PDF for All Bank Prelims Exams

(e) C

Direction (11-15): Study the following information carefully and answer the question given below:

There are seven people A, B, C, D, E, F and G are living in a 7-floor building on different floors from top to bottom (such as ground floor is numbered as 1 and top floor is numbered as 7) but not necessarily in the same order. A live on the 2nd floor. E live immediately above F. B live above F. A live immediately above D and immediately below G. There are four persons live between D and C.

11. Who among the following lives on ground floor?

- (a) A
- (b) D
- (c) B
- (d) G
- (e) None of these

12. Who among the following lives immediately below B?

- (a) G
- (b) D
- (c) C
- (d) F
- (e) None of these

13. How many persons live between D and B?

- (a) One
- (b) Three
- (c) Five
- (d) Two
- (e) None of these

14. Who among the following lives on Top floor?

- (a) E
- (b) A
- (c) F
- (d) C
- (e) None of these

15. Which of the following combination is false?

- (a) Floor no. 2 – A
- (b) Floor no. 7 – B
- (c) Floor no. 5 – C
- (d) Floor no. 3 – G
- (e) None of these

Direction (16-20): Study the following information carefully and answer the question given below:

There are Eleven people A, B, C, D, E, F, G, H, I, J and K are living in a 11 floor building on different floors from top to bottom (such as ground floor is numbered as 1 and top floor is numbered as 11) but not necessarily in the same order. A live above F. I live above E but not immediately. E does not live immediately above or immediately below C. G lives on 7th floor. Two person live between G and H. D live immediately above H. There is as many person living above D as below B. Five persons live between F and K, who lives below G. Only one person live between G and C. J lives below C

16. Who among the following live immediately above C?

- (a) D
- (b) I
- (c) F
- (d) E



Ultra Practice Bundle PDF for All Bank Prelims Exams

(e) None of these

17. How many persons are there between E and B?

- (a) One
- (b) Two
- (c) Three
- (d) Four
- (e) None of these

18. Who among the following lives on the topmost floor?

- (a) G
- (b) C
- (c) J
- (d) D
- (e) None of these

19. Which of the following combinations is/are true?

- (a) Floor no. 2 – D
- (b) Floor no. 7 – F
- (c) Floor no. 5 – C
- (d) Floor no. 8 – E
- (e) None of these

20. Which of the following live just below J?

- (a) K
- (b) E
- (c) B
- (d) I
- (e) None of these

Direction (21-25): Study the following information carefully and answer the question given below:

There are eight people A, B, C, D, E, F, G and H are living in a 8 floor Building on different floors from top to bottom (such as ground floor is numbered as 1 and top floor is numbered as 8) but not necessarily in the same order. No two persons according to alphabetical order live adjacent to each other (A does not live just above or below B, B does not live just above or below A and C, and so on). D live either 2nd or 7th floor. Only two persons live between C and F. E lives immediately below C. G live above F but not at the topmost floor. Only one person sit between B and F. C live on 6th floor.

Q21. Who lives on floor number Two?

- (a) C
- (b) F
- (c) D
- (d) E
- (e) None of these

Q22. How many persons live between G and H?

- (a) One
- (b) Three
- (c) Two
- (d) Four
- (e) None of these

Q23. Who lives immediate below B?

- (a) G
- (b) A
- (c) D
- (d) H

Ultra Practice Bundle PDF for All Bank Prelims Exams

(e) No One

Q24. Four of the following five are alike in a certain way based on the given arrangement and thus form a group. Which is the one that does not belong to that group?

- (a) C
- (b) E
- (c) F
- (d) B
- (e) G

Q25. Who lives on 4TH floor?

- (a) D
- (b) H
- (c) E
- (d) F
- (e) None of these

Direction (26-30): Study the following information carefully and answer the question given below:

There are eight people A, B, C, D, E, F, G and H are living in a 8 floor Building on different floors from top to bottom (such as ground floor is numbered as 1 and top floor is numbered as 8) but not necessarily in the same order. A lives on an odd floor below 6th floor. There are two persons live between A and B. G lives on one of the odd floor but not at bottom most floor. There is only one person live between B and D, who live just below E. The number of persons living between F and C is same as the number of person living between F and D. C live on of the floor below F.

Q26. Who among the following live on the Even floor?

I. F

II. B

III. C

- (a) Only I
- (b) Only II
- (c) Only I and III
- (d) Only I and II
- (e) All I, II, III

Q27. Who among the following live immediate below G?

- (a) D
- (b) A
- (c) C
- (d) B
- (e) None of these

Q28. Four of the following five are alike in a certain way based on the given arrangement and thus form a group. Which is the one that does not belong to that group?

- (a) G
- (b) F
- (c) B
- (d) D
- (e) C

Q29. What is the difference between the floor number of B and G?

- (a) Five
- (b) Three
- (c) Two

Ultra Practice Bundle PDF for All Bank Prelims Exams

- (d) One
- (e) None of these

Q30. Who lives immediately above H?

- (a) G
- (b) A
- (c) B
- (d) D
- (e) C

Direction (31-35): Study the following information carefully and answer the question given below:

There are eight people A, B, C, D, E, F, G and H are living in a 8 floor Building on different floors from top to bottom (such as ground floor is numbered as 1 and top floor is numbered as 8) but not necessarily in the same order. A lives on an even-numbered floor but not on the floor numbered second or fourth. Only three floors are there between A and B. Only two people live between C and E. F lives on a floor above D. There are equal numbers of floors between the floors on which E and B live and between the floors on which A and E live. H lives immediately below D's floor. G lives immediately below A's floor.

Q31. Who lives on floor number Two?

- (a) C
- (b) F
- (c) A
- (d) E
- (e) None of these

Q32. How many persons live between D and F?

- (a) One
- (b) Three

- (c) Two
- (d) Four
- (e) None of these

Q33. Who lives immediate below B?

- (a) G
- (b) C
- (c) D
- (d) H
- (e) No One

Q34. Four of the following five are alike in a certain way based on the given arrangement and thus form a group. Which is the one that does not belong to that group?

- (a) F
- (b) C
- (c) E
- (d) H
- (e) G

Q35. Who lives on 6th floor?

- (a) D
- (b) A
- (c) E
- (d) F
- (e) G

Direction (36-40): Study the following information carefully and answer the question given below:

There are eight people S, T, U, V, W, X, Y and Z are living in a 8 floor Building on different floors from top to bottom (such as ground floor is numbered as 1 and top

Ultra Practice Bundle PDF for All Bank Prelims Exams

floor is numbered as 8) but not necessarily in the same order.

Only one person lives between the floors of U and V who lives on any floor below the floor of W. Z lives on the floor immediately above the floor on which T lives. U lives on the third numbered floor. Only one person lives between the floors of W and X. W lives above X. Only two persons live between the floors of U and Y.

Q36. _____ is at the bottommost position.

- (a) Z
- (b) Y
- (c) Either (a) or (b)
- (d) U
- (e) None of these

Q37. Who among the following live on the odd floor?

- I. W**
- II. T**
- III. V**

- (a) Only I
- (b) Only II
- (c) Only II and III
- (d) Only I and II
- (e) Only III

Q38. Who among the following live immediate below X?

- (a) Z
- (b) V
- (c) T
- (d) Y

(e) None of these

Q39. Four of the following five are alike in a certain way based on the given arrangement and thus form a group. Which is the one that does not belong to that group?

- (a) T
- (b) X
- (c) W
- (d) Y
- (e) Z

Q40. What is the difference between the floor number of Y and X?

- (a) One
- (b) Three
- (c) Four
- (d) Two
- (e) None of these

Direction (41-45): Study the following information carefully and answer the question given below:

There are eight people A, B, C, D, J, K, L and M are living in a 8 floor Building on different floors from top to bottom (such as ground floor is numbered as 1 and top floor is numbered as 8) but not necessarily in the same order.

J lives immediately above the floor on which C lives but not on an even numbered floor. D lives on the floor which is a prime number but not on the 3rd floor. K lives immediately below the floor on which B lives. The person lives between A and C is not more than three and not less than two. A live on the topmost floor. There is one person living between the floors on which J and D lives. M lives immediately above the floor on which B lives.

Ultra Practice Bundle PDF for All Bank Prelims Exams

41. Who among the following live immediately above M?

- (a) D
- (b) C
- (c) J
- (d) L
- (e) None of these

42. How many persons are there between A and M?

- (a) One
- (b) Two
- (c) Three
- (d) Four
- (e) None of these

43. Who among the following lives on the bottom most floor?

- (a) L
- (b) C
- (c) J
- (d) K
- (e) None of these

44. Which of the following combinations is/are false?

- (a) Floor no. 2 – K
- (b) Floor no. 7 – D
- (c) Floor no. 5 – J
- (d) Floor no. 8 – A
- (e) None of these

45. Which of the following live just below L?

- (a) K
- (b) D
- (c) J
- (d) B
- (e) None of these

Direction (46-50): Study the following information carefully and answer the question given below:

There are seven people A, B, C, D, E, F, G are living in a 7 floor Building on different floors from top to bottom (such as ground floor is numbered as 1 and top floor is numbered as 7) but not necessarily in the same order. G lives on one of the odd numbered floor above D but not on top floor. F lives immediately before C, who lives in bottom most floor. A lives on an odd numbered floor but not on the floor numbered 3. B lives on immediately below A. Only one person lives between B and E and they lives on even numbered floor. G lives above E.

Q46. Who among the following live on the even floor?

I. F

II. B

III. C

- (a) Only I
- (b) Only II
- (c) Only I and II
- (d) Only II and III
- (e) Only III

Q47. Who among the following live immediately below C?

- (a) D

Ultra Practice Bundle PDF for All Bank Prelims Exams

- (b) A
- (c) G
- (d) B
- (e) No one

Q48. Four of the following five are alike in a certain way based on the given arrangement and thus form a group. Which is the one that does not belong to that group?

- (a) G
- (b) A
- (c) E
- (d) D
- (e) C

Q49. What is the difference between the floor number of A and C?

- (a) One
- (b) Three
- (c) Six
- (d) Two
- (e) None of these

Q50. Who lives immediately above G?

- (a) B
- (b) A
- (c) E
- (d) D
- (e) C

Solutions with detailed Explanation

SOLUTION (1-5):

Explanation in detail:

1. A lives on floor number 6.
2. There is a gap of three floors between B and D and both of them live on odd number of floors.
3. D lives above A.

FLOORS	PERSONS
8	
7	D
6	A
5	
4	
3	B
2	
1	

4. F lives just above H who lives on an even numbered floor.
5. Only one person lives between B and E.



Ultra Practice Bundle PDF for All Bank Prelims Exams

6. Three persons live between C and H.

Floors	Persons
8	C
7	D
6	A
5	F
4	H
3	B
2	G
1	E

- b
- d
- a
- d
- e

SOLUTION (6-10):

Explanation in detail:

- F lives on an odd number floor but does not live on 3rd floor.
- H lives immediate below F.

Floor	CASE1	CASE2
8		
7	F	
6	H	
5		F
4		H
3		
2		
1		

- More than two persons live between G and H.
- There are six persons live between A and G.

Floor	CASE1	CASE2
8	A	G
7	F	
6	H	
5		F
4		H
3		
2		
1	G	A

- D lives immediate above E but live below B.
- C does not live above F.
- E does not live immediate above G.



Ultra Practice Bundle PDF for All Bank Prelims Exams

Floor	CASE1	CASE2
8	A	G
7	F	
6	H	
5	B	F
4	D	H
3	E	D
2	C	E
1	G	A

So CASE2 is cancelled out.

Final Arrangement:

Floor	Persons
8	A
7	F
6	H
5	B
4	D
3	E
2	C
1	G

- 6. d
- 7. c
- 8. a
- 9. d

10. b

SOLUTION (11-15):

Explanation in detail:

1. A lives on the 2nd floor.
2. A lives immediately above D and immediately below G.

FLOOR	PERSONS
7	
6	
5	
4	
3	G
2	A
1	D

3. There are four persons live between D and C.
4. D live below C.

FLOOR	PERSONS
7	
6	C
5	
4	
3	G
2	A
1	D

5. E live immediately above F.



Ultra Practice Bundle PDF for All Bank Prelims Exams

6. B live above F.

FLOOR	PERSONS
7	B
6	C
5	E
4	F
3	G
2	A
1	D

11. b

12. c

13. c

14. e

15. c

SOLUTION (16-20):

Explanation in detail:

1. G lives on 7th floor.

2. Two person live between G and H.

3. D live immediately above H.

Floor	CASE1	CASE2
11	D	
10	H	
9		
8		
7	G	G
6		
5		D
4		H
3		
2		
1		

4. There is as many person living living above D as below B.

Floor	CASE1	CASE2
11	D	
10	H	
9		
8		
7	G	G
6		
5		D
4		H
3		
2		
1	B	

There is no floor empty for B in CASE2 so CASE2 is cancelled out.

5. A live above F.

6. Five persons live between F and K, who lives below G.



Ultra Practice Bundle PDF for All Bank Prelims Exams

Floor	CASE1
11	D
10	H
9	A
8	F
7	G
6	
5	
4	
3	
2	K
1	B

7. Only one person live between G and C.
 8. I live above E but not immediately.
 9. E does not live immediately above or immediately below C.

Floor	CASE1
11	D
10	H
9	A
8	F
7	G
6	I
5	C
4	J
3	E
2	K
1	B

16. b
 17. a
 18. d
 19. c
 20. b

SOLUTION (21-25):

Explanation in detail:

1. C live on 6th floor.
2. E lives immediately below C.

Floor	Person
8	
7	
6	C
5	E
4	
3	
2	
1	

3. Only two persons live between C and F.
4. G live above F but not at the topmost floor.

Floor	Person
8	
7	G
6	C
5	E
4	
3	F
2	
1	

Note: G live on 7th floor not on 4th floor because no two persons according to alphabetical order live adjacent to each other.

5. Only one person sit between B and F.
6. D live either 2nd or 7th floor.



Ultra Practice Bundle PDF for All Bank Prelims Exams

Floor	Person
8	
7	G
6	C
5	E
4	
3	F
2	D

H cannot sit on topmost floor because no two persons according to alphabetical order live adjacent to each other.

Floor	Person
8	A
7	G
6	C
5	E
4	H
3	F
2	D
1	B

21. c

22. c

23. e

24. a

25. b

SOLUTION (26-30):**Explanation in detail:**1. A lives on an odd floor below 6th floor.

2. There are two persons live between A and B.

Floor	CASE1	CASE2	CASE3A	CASE3B
8			B	
7				
6		B		
5			A	A
4	B			
3		A		
2				B
1	A			

3. There is only one person live between B and D, who live just below E.

4. The number of persons living between F and C is same as the number of person living between F and D.

Floor	CASE1	CASE2	CASE3A	CASE3B
8	C		B	
7			E	
6		B	D	
5	F	E	A	A
4	B	D	F	
3	E	A		
2	D		C	B
1	A			

There is no floor empty for E in CASE3B So, CASE3B is cancelled out.

There is no floor empty for F in CASE2 So, CASE2 is cancelled out.

5. C live on of the floor below F.

6. G lives on one of the odd floor but not at bottom most floor.



Ultra Practice Bundle PDF for All Bank Prelims Exams

So, CASE1 is cancelled out.

Floor	CASE1	CASE3A
8	C	B
7		E
6		D
5	F	A
4	B	F
3	E	G
2	D	C
1	A	H

Final arrangement:

Floor	Persons
8	B
7	E
6	D
5	A
4	F
3	G
2	C
1	H

26. e

27. c

28. a

29. a

30. e

SOLUTION (31-35):

Explanation in detail:

1. A lives on an even-numbered floor but not on the floor numbered second or fourth.
2. Only three floors are there between A and B.

Floor	CASE1	CASE2
8	A	
7		
6		A
5		
4	B	
3		
2		B
1		

3. There are equal numbers of floors between the floors on which E and B live and between the floors on which A and E live.
4. Only two people live between C and E.



Ultra Practice Bundle PDF for All Bank Prelims Exams

Floor	CASE1	CASE2A	CASE2B
8	A		
7		C	
6	E	A	A
5			
4	B	E	E
3	C		
2		B	B
1			C

Floor	CASE1
8	A
7	G
6	E
5	F
4	B
3	C
2	D
1	H

- F lives on a floor above D.
- H lives immediately below D's floor.
- G lives immediately below A's floor.

- e
- c
- b
- c
- c

Floor	CASE1	CASE2A	CASE2B
8	A		D
7	G	C	H
6	E	A	A
5	F	G	G
4	B	E	E
3	C		
2	D	B	B
1	H		C

SOLUTION (36-40):

Explanation in detail:

- U lives on the third numbered floor.
- Only two persons live between the floors of U and Y.

Floor	Person
8	
7	
6	Y
5	
4	
3	U
2	
1	

There is no flat empty for H and D in CASE2A so CASE2A is cancelled out.

F lives on a floor below D in CASE2B so CASE2B is cancelled out.

Final arrangement:



Ultra Practice Bundle PDF for All Bank Prelims Exams

3. Only one person lives between the floors of W and X.
 4. W lives above X.

Floor	CASE1A	CASE1B
8		
7	W	
6	Y	Y
5	X	
4		W
3	U	U
2		X
1		

5. Only one person lives between the floors of U and V.
 6. U lives on one of the floor below the floor of W.
 7. Z lives on the floor immediately above the floor on which T lives.

Floor	CASE1A	CASE1B
8		Z
7	W	T
6	Y	Y
5	X	S
4		W
3	U	U
2		X
1	V	V

There is no space for Z and T in CASE1A so CASE1A is cancelled out.

Final arrangement:

Floor	CASE1B
8	Z
7	T
6	Y
5	S
4	W
3	U
2	X
1	V

36. e
 37. c
 38. b
 39. a
 40. c

SOLUTION (41-45):

Explanation in detail:

- D lives on the floor which is a prime number but not on the 3rd floor.
- A lives on the topmost floor.

FLOOR	CASE1	CASE2	CASE3
8	A	A	A
7			D
6			
5		D	
4			
3			
2	D		
1			

- J lives immediately above the floor on which C lives but not on an even numbered floor.



Ultra Practice Bundle PDF for All Bank Prelims Exams

4. There is one person living between the floors on which J and D lives.

FLOOR	CASE1	CASE2A	CASE2B	CASE3
8	A	A	A	A
7		J		D
6		C		
5		D	D	J
4				C
3			J	
2	D		C	
1				

In CASE1 J live in even floor so CASE1 is cancelled out.

5. The person lives between A and C is not more than three and not less than two.

FLOOR	CASE2A	CASE2B	CASE3
8	A	A	A
7	J		D
6	C		
5	D	D	J
4			C
3		J	
2		C	
1			

In CASE2A and CASE2B the person lives between A and C is more than three and less than two.

So, CASE2A and CASE2B is cancelled out.

6. M lives immediately above the floor on which B lives.

7. K lives immediately below the floor on which B lives.

FLOOR	CASE3
8	A
7	D
6	L
5	J
4	C
3	M
2	B
1	K

41. b

42. d

43. d

44. a

45. c

SOLUTION (46-50):

Explanation in detail:

1. G lives on one of the odd numbered floor above D but not on top floor.

2. Only three persons lives between C and G.

Floor	CASE1	CASE2
7	C	
6		
5		G
4		
3	G	
2		
1		C



Ultra Practice Bundle PDF for All Bank Prelims Exams

3. F lives immediately before C.

Floor	CASE1	CASE2
7	C	
6		
5		G
4		
3	G	
2		F
1		C

There is no floor empty for F in CASE1 so CASE1 is cancelled out.

Floor	CASE2
7	
6	
5	G
4	
3	
2	F
1	C

4. A lives on an odd numbered floor but not on the floor numbered 3.

5. B lives on immediately below A.

6. Only one person lives between B and E and they lives on even numbered floor.

Floor	CASE2
7	A
6	B
5	G
4	E
3	D
2	F
1	C

46. c

47. e

48. c

49. c

50. a

24.Syllogism

Directions (1-50): In each of the questions below are given some statements followed by some Conclusions. You have to take the given statements to be true even, if they seem to be at variance from commonly known facts. Read all the conclusions and then decide which of the given conclusions logically follows from the given statements disregarding commonly known facts.

(a) If Only conclusion I follows.

(b) If Only conclusion II follows.

(c) If Either conclusion I or II follows.

(d) If Neither conclusion I nor II follows.

(e) If Both conclusions I and II follow.

1. Statements:

Few Bike are Car.

Some Truck is Jeep.

Ultra Practice Bundle PDF for All Bank Prelims Exams

Only a few Jeep are Car.

Conclusions:

I. Few Bike are Truck.

II. All jeeps are Bike is possibility.

(a) If Only conclusion I follows.

(b) If Only conclusion II follows.

(c) If Either conclusion I or II follows.

(d) If Neither conclusion I nor II follows.

(e) If Both conclusions I and II follow.

2. Statements:

All Power are Strong.

Some Strong are not Leader.

All Leader are Fat.

Conclusions:

I. All Leader are Power is a possibility

II. Some Fat are Strong

(a) If Only conclusion I follows.

(b) If Only conclusion II follows.

(c) If Either conclusion I or II follows.

(d) If Neither conclusion I nor II follows.

(e) If Both conclusions I and II follow.

3. Statements:

All Sun are Moon.

Some Star are Moon.

No Star are Planet.

Conclusions:

I. Some Sun are Star.

II. Some Planet are Sun is possibility.

(a) If Only conclusion I follows.

(b) If Only conclusion II follows.

(c) If Either conclusion I or II follows.

(d) If Neither conclusion I nor II follows.

(e) If Both conclusions I and II follow.

4. Statements:

Few Cup are Plates.

Some Plates are Fiber.

No Plastic are Cup.

Conclusions:

I. Some Fiber are Cup is possibility.

II. Some Plastic are Plates is possibility.

(a) If Only conclusion I follows.

(b) If Only conclusion II follows.

(c) If Either conclusion I or II follows.

(d) If Neither conclusion I nor II follows.

(e) If Both conclusions I and II follow.

5. Statements:

Few Cup are Plates.

Some Plates are Fiber.

No Plastic are Cup.

Conclusions:

Ultra Practice Bundle PDF for All Bank Prelims Exams

- I.** Some Fiber are Plastic.
II. Some Plates are Plastic.

- (a) If Only conclusion I follows.
(b) If Only conclusion II follows.
(c) If Either conclusion I or II follows.
(d) If Neither conclusion I nor II follows.
(e) If Both conclusions I and II follow.

6. Statements:

Only a few Bowls are Spoons.

Some Spoons are Forks.

No Forks are Plates.

Conclusions:

- I.** Few Forks are Bowls.
II. Few Plates are Bowls.

- (a) If Only conclusion I follows.
(b) If Only conclusion II follows.
(c) If Either conclusion I or II follows.
(d) If Neither conclusion I nor II follows.
(e) If Both conclusions I and II follow.

7. Statements:

Some Red is Black.
Some Black is Yellow.
All Yellow is Green.

Conclusions:

- I.** Few Red is Yellow.
II. Few Black is Green.

- (a) If Only conclusion I follows.

- (b) If Only conclusion II follows.
(c) If Either conclusion I or II follows.
(d) If Neither conclusion I nor II follows.
(e) If Both conclusions I and II follow.

8. Statements:

Some Date are Month

No Date is Year

Only Week are Year

Conclusion:

I: Some Week are not Date

II: Some Month are not Week.

- (a) If Only conclusion I follows.
(b) If Only conclusion II follows.
(c) If Either conclusion I or II follows.
(d) If Neither conclusion I nor II follows.
(e) If Both conclusions I and II follow.

9. Statements:

Few Police are Force.

No force is Army.

All Army are Wise.

Conclusion:

I: Some Force is not Wise

II: Some Police are Army.

- (a) If Only conclusion I follows.
(b) If Only conclusion II follows.
(c) If Either conclusion I or II follows.



Ultra Practice Bundle PDF for All Bank Prelims Exams

- (d) If Neither conclusion I nor II follows.
- (e) If Both conclusions I and II follow.

10. Statements:

No Black is Paper.

All Pencils are Black.

Few Pens are not Pencils.

Conclusion:

I: All Black is Pen.

II: Some Paper is not Pencil.

- (a) If Only conclusion I follows.
- (b) If Only conclusion II follows.
- (c) If Either conclusion I or II follows.
- (d) If Neither conclusion I nor II follows.
- (e) If Both conclusions I and II follow.

11. Statements:

All North are South.

All South are East.

All East are West.

Conclusion:

I: All North is West.

II: Some West is South.

- (a) If Only conclusion I follows.
- (b) If Only conclusion II follows.
- (c) If Either conclusion I or II follows.

- (d) If Neither conclusion I nor II follows.
- (e) If Both conclusions I and II follow.

12. Statements:

Few Doctors are Ideal.

Few women are doctors.

All Ideal is Perfect.

Conclusion:

I: All Doctors are Perfect.

II: Few Women are Ideal is possibility.

- (a) If Only conclusion I follows.
- (b) If Only conclusion II follows.
- (c) If Either conclusion I or II follows.
- (d) If Neither conclusion I nor II follows.
- (e) If Both conclusions I and II follow.

13. Statements:

All Cricketer are Batsmen

Few Batsmen are Keeper.

All Keeper are Fielder.

Conclusion:

I: All Fielder can be Cricketer.

II: Few Batsmen are Fielder.

- (a) If Only conclusion I follows.
- (b) If Only conclusion II follows.
- (c) If Either conclusion I or II follows.



Ultra Practice Bundle PDF for All Bank Prelims Exams

- (d) If Neither conclusion I nor II follows.
(e) If Both conclusions I and II follow.

14. Statements:

All File are Complete.

Few File are Check.

Only a few Check are wrong

Conclusion:

I: All Check are wrong is a possibility.

II: All Complete are Check.

- (a) If Only conclusion I follows.
(b) If Only conclusion II follows.
(c) If Either conclusion I or II follows.
(d) If Neither conclusion I nor II follows.
(e) If Both conclusions I and II follow.

15. Statements:

No Cat is Rat.

No Rat is Bat.

Only a few Bat are Cow.

Conclusions:

I. Few Cat are Cow is a possibility.

II. All Bat are Cow is possibility.

- (a) If Only conclusion I follows.
(b) If Only conclusion II follows.
(c) If Either conclusion I or II follows.
(d) If Neither conclusion I nor II follows.

- (e) If Both conclusions I and II follow.

16. Statements:

Some Light are Bulb.

No Bulb is Current.

Only a few Current are Glow.

Conclusions:

I. Some light are Current is a possibility.

II. Some Glow are Bulb is possibility.

- (a) If Only conclusion I follows.
(b) If Only conclusion II follows.
(c) If Either conclusion I or II follows.
(d) If Neither conclusion I nor II follows.
(e) If Both conclusions I and II follow.

17. Statements:

Few School are College.

Some School is not Centre.

No College are Open.

Conclusions:

I. Some Centre are Open.

II. Some School are Centre.

- (a) If Only conclusion I follows.
(b) If Only conclusion II follows.
(c) If Either conclusion I or II follows.
(d) If Neither conclusion I nor II follows.

Ultra Practice Bundle PDF for All Bank Prelims Exams

(e) If Both conclusions I and II follow.

18. Statements:

Some Men are Smart

Some Smart are Handsome

No Handsome is Attitude

Conclusion:

I: All Smart is Men

II: All Men are Handsome

(a) If Only conclusion I follows.

(b) If Only conclusion II follows.

(c) If Either conclusion I or II follows.

(d) If Neither conclusion I nor II follows.

(e) If Both conclusions I and II follow.

19. Statements:

All Movies are Good.

No Good is Bad.

All Bad is Disaster.

Conclusions:

I. Some Good are not Disaster.

II. Some Disaster can never be movie.

(a) If Only conclusion I follows.

(b) If Only conclusion II follows.

(c) If Either conclusion I or II follows.

(d) If Neither conclusion I nor II follows.

(e) If Both conclusions I and II follow.

20. Statements:

Only Grapes are Mango.

Some grapes are Orange.

No Orange is Litchi

Conclusions:

I. Some Mango are Orange.

II. All Orange can be Grapes.

(a) If Only conclusion I follows.

(b) If Only conclusion II follows.

(c) If Either conclusion I or II follows.

(d) If Neither conclusion I nor II follows.

(e) If Both conclusions I and II follow.

21. Statements:

Some Subject are Reasoning.

All Reasoning are Logical.

No Logical is Critical.

Conclusions:

I. Some Subject are Critical is possibility.

II. Few Logical are Subject.

(a) If Only conclusion I follows.

(b) If Only conclusion II follows.

(c) If Either conclusion I or II follows.

(d) If Neither conclusion I nor II follows.

Ultra Practice Bundle PDF for All Bank Prelims Exams

(e) If Both conclusions I and II follow.

22. Statements:

Some Tea are Strong.

No Tea is a Coffee.

Some Coffee are not Strong.

All Coffee are not Hot.

Conclusions:

I. Some Tea are Hot.

II. Some Hot are Strong.

(a) If Only conclusion I follows.

(b) If Only conclusion II follows.

(c) If Either conclusion I or II follows.

(d) If Neither conclusion I nor II follows.

(e) If Both conclusions I and II follow.

23. Statements:

Some Tea are Strong.

No Tea is a Coffee.

Some Coffee are not Strong.

All Coffee are not Hot.

Conclusions:

I. Some Strong are Hot is possibility.

II. Some Coffee are Strong is possibility.

(a) If Only conclusion I follows.

(b) If Only conclusion II follows.

(c) If Either conclusion I or II follows.

(d) If Neither conclusion I nor II follows.

(e) If Both conclusions I and II follow.

24. Statements:

Some File are Copy.

Some Copy are Eraser.

No Pen is File.

Conclusions:

I. Some File are Eraser

II. No File is Eraser

(a) If Only conclusion I follows.

(b) If Only conclusion II follows.

(c) If Either conclusion I or II follows.

(d) If Neither conclusion I nor II follows.

(e) If Both conclusions I and II follow.

25. Statements:

Some File are Copy.

Some Copy are Eraser.

No Pen is File.

Conclusions:

I. Some Copy are Pen is possibility.

II. No Copy are Pen.

(a) If Only conclusion I follows.

(b) If Only conclusion II follows.

(c) If Either conclusion I or II follows.

(d) If Neither conclusion I nor II follows.



Ultra Practice Bundle PDF for All Bank Prelims Exams

(e) If Both conclusions I and II follow.

26. Statements:

Some Boys are Students.

All students are Talented.

Some Girls are Talented.

Conclusions:

I. Some Boys are Talented.

II. Some Girls are Students.

(a) If Only conclusion I follows.

(b) If Only conclusion II follows.

(c) If Either conclusion I or II follows.

(d) If Neither conclusion I nor II follows.

(e) If Both conclusions I and II follow.

27. Statements:

Some Boys are Students.

All students are Talented.

Some Girls are Talented.

Conclusions:

I. Some Boys are Girls.

II. Some Students are Talented.

(a) If Only conclusion I follows.

(b) If Only conclusion II follows.

(c) If Either conclusion I or II follows.

(d) If Neither conclusion I nor II follows.

(e) If Both conclusions I and II follow.

28. Statements:

No Black is White.

Some White are Green.

Some Brown is Green.

No Brown is White.

Conclusions:

I. All Green being Brown is a possibility.

II. Only a few Green are Whites.

(a) If Only conclusion I follows.

(b) If Only conclusion II follows.

(c) If Either conclusion I or II follows.

(d) If Neither conclusion I nor II follows.

(e) If Both conclusions I and II follow.

29. Statements:

No Black is White.

Some White are Green.

Some Brown is Green.

No Brown is White.

Conclusions:

I. No Black is Brown.

II. Only a few Brown are Green.

(a) If Only conclusion I follows.

(b) If Only conclusion II follows.

(c) If Either conclusion I or II follows.

Ultra Practice Bundle PDF for All Bank Prelims Exams

- (d) If Neither conclusion I nor II follows.
(e) If Both conclusions I and II follow.

30. Statements:

No Goa is Pune.

Some Mumbai is Navi.

All Nashik are Mumbai.

Only a few Mumbai are Goa.

Conclusions:

- I. Some Goa is Navi.
II. All Nashik can never be Goa.

- (a) If Only conclusion I follows.
(b) If Only conclusion II follows.
(c) If Either conclusion I or II follows.
(d) If Neither conclusion I nor II follows.
(e) If Both conclusions I and II follow.

31. Statements:

No Goa is Pune.

Some Mumbai is Navi.

All Nashik are Mumbai.

Only a few Mumbai are Goa.

Conclusions:

- I. Some Pune is Navi.
II. All Nashik can be Pune.

- (a) If Only conclusion I follows.
(b) If Only conclusion II follows.
(c) If Either conclusion I or II follows.

- (d) If Neither conclusion I nor II follows.
(e) If Both conclusions I and II follow.

32. Statements:

No Road is Wide.

Some Road is Long.

Only a few Light is Fuse.

All Fuse are Long.

Conclusions:

- I. Some Wide is Light.
II. All Long can be Light.

- (a) If Only conclusion I follows.
(b) If Only conclusion II follows.
(c) If Either conclusion I or II follows.
(d) If Neither conclusion I nor II follows.
(e) If Both conclusions I and II follow.

33. Statements:

No Road is Wide.

Some Road is Long.

Only a few Light is Fuse.

All Fuse are Long.

Conclusions:

- I. All Wide can be Long.
II. All Long can be Road.

- (a) If Only conclusion I follows.
(b) If Only conclusion II follows.
(c) If Either conclusion I or II follows.
(d) If Neither conclusion I nor II follows.

Ultra Practice Bundle PDF for All Bank Prelims Exams

(e) If Both conclusions I and II follow.

34. Statements:

Only a few Beers are Pale.

No Book is a Beers.

A few Book are Pale.

Conclusions:

I. All Pale being Book is a possibility

II. All Beers can never be Pale.

(a) If Only conclusion I follows.

(b) If Only conclusion II follows.

(c) If Either conclusion I or II follows.

(d) If Neither conclusion I nor II follows.

(e) If Both conclusions I and II follow.

35. Statements:

Only a few Bat are Wicket.

No Bat is Out.

Only a few LBW are Wicket.

Some Out is Catch.

Conclusions:

I. Some LBW can never be Out.

II. Some Catch is LBW.

(a) If Only conclusion I follows.

(b) If Only conclusion II follows.

(c) If Either conclusion I or II follows.

(d) If Neither conclusion I nor II follows.

(e) If Both conclusions I and II follow.

36. Statements:

Only a few Bat are Wicket.

No Bat is Out.

Only a few LBW are Wicket.

Some Out is Catch.

Conclusions:

I. Some Wicket being Out is Possibility.

II. Some Bat is being Catch is Possibility.

(a) If Only conclusion I follows.

(b) If Only conclusion II follows.

(c) If Either conclusion I or II follows.

(d) If Neither conclusion I nor II follows.

(e) If Both conclusions I and II follow.

37. Statements:

Only a few Bat are Wicket.

No Bat is Out.

Only a few LBW are Wicket.

Some Out is Catch.

Conclusions:

I. Some Bat are LBW.

II. All Catch being Out is possibility.

(a) If Only conclusion I follows.

(b) If Only conclusion II follows.

(c) If Either conclusion I or II follows.

(d) If Neither conclusion I nor II follows.

Ultra Practice Bundle PDF for All Bank Prelims Exams

(e) If Both conclusions I and II follow.

38. Statements:

Only a few Uber are Ola.

Only a few Rapido are Ola.

No Auto is Rapido.

Conclusions:

I. All Ola can be Rapido.

II. All Rapido can be Uber.

(a) If Only conclusion I follows.

(b) If Only conclusion II follows.

(c) If Either conclusion I or II follows.

(d) If Neither conclusion I nor II follows.

(e) If Both conclusions I and II follow.

39. Statements:

Only a few Uber are Ola.

Only a few Rapido are Ola.

No Auto is Rapido.

Conclusions:

I. All Uber are Auto.

II. Some Rapido are Uber.

(a) If Only conclusion I follows.

(b) If Only conclusion II follows.

(c) If Either conclusion I or II follows.

(d) If Neither conclusion I nor II follows.

(e) If Both conclusions I and II follow.

40. Statements:

Only a few Uber are Ola.

Only a few Rapido are Ola.

No Auto is Rapido.

Conclusions:

I. All Auto are Ola.

II. Some Uber are not Rapido.

(a) If Only conclusion I follows.

(b) If Only conclusion II follows.

(c) If Either conclusion I or II follows.

(d) If Neither conclusion I nor II follows.

(e) If Both conclusions I and II follow.

41. Statements:

No Mail is a Project.

Only a few Projects are Post.

Some Post are Mail.

Conclusions:

I. Some Post are definitely not project.

II. All Post are project.

(a) If Only conclusion I follows.

(b) If Only conclusion II follows.

(c) If Either conclusion I or II follows.

(d) If Neither conclusion I nor II follows.

(e) If Both conclusions I and II follow.

42. Statements:

Ultra Practice Bundle PDF for All Bank Prelims Exams

No Mail is a Project.

Only a few Projects are Post.

Some Post are Mail.

Conclusions:

II. All Mail are projects.

III. All Mail being Post is a possibility.

- (a) If Only conclusion I follows.
- (b) If Only conclusion II follows.
- (c) If Either conclusion I or II follows.
- (d) If Neither conclusion I nor II follows.
- (e) If Both conclusions I and II follow.

43. Statements:

All Area are Square.

All Square are Triangle.

Some Triangle are Rectangle.

All Rectangle are Cube.

Conclusions:

- I. All Cube are Square.
 - II. Some Triangle are Cube is possibility.
- (a) If Only conclusion I follows.
 - (b) If Only conclusion II follows.
 - (c) If Either conclusion I or II follows.
 - (d) If Neither conclusion I nor II follows.
 - (e) If Both conclusions I and II follow.

44. Statements:

All Area are Square.

All Square are Triangle.

Some Triangle are Rectangle.

All Rectangle are Cube.

Conclusions:

- I. All Square are Area.
 - II. All Area are Triangle.
- (a) If Only conclusion I follows.
 - (b) If Only conclusion II follows.
 - (c) If Either conclusion I or II follows.
 - (d) If Neither conclusion I nor II follows.
 - (e) If Both conclusions I and II follow.

45. Statements:

All Area are Square.

All Square are Triangle.

Some Triangle are Rectangle.

All Rectangle are Cube.

Conclusions:

- I. All triangle can be square.
 - II. All Square are Cube.
- (a) If Only conclusion I follows.
 - (b) If Only conclusion II follows.
 - (c) If Either conclusion I or II follows.
 - (d) If Neither conclusion I nor II follows.
 - (e) If Both conclusions I and II follow.

Ultra Practice Bundle PDF for All Bank Prelims Exams

46. Statements:

All One is Three.

Only a few Three are Five.

Some Five are Two.

All Two are Seven.

Conclusions:

I. Some One can be Five.

II. All Two are Three.

(a) If Only conclusion I follows.

(b) If Only conclusion II follows.

(c) If Either conclusion I or II follows.

(d) If Neither conclusion I nor II follows.

(e) If Both conclusions I and II follow.

47. Statements:

No One is Three.

Only a few Three are Five.

Some Five are Two.

All Two are Seven.

Conclusions:

I. All Three are Seven.

II. Some Two are definitely Five.

(a) If Only conclusion I follows.

(b) If Only conclusion II follows.

(c) If Either conclusion I or II follows.

(d) If Neither conclusion I nor II follows.

(e) If Both conclusions I and II follow.

48. Statements:

No One is Three.

Only a few Three are Five.

Some Five are Two.

All Two are Seven.

Conclusions:

I. All Two being Three is possibility.

II. All Five can be Seven.

(a) If Only conclusion I follows.

(b) If Only conclusion II follows.

(c) If Either conclusion I or II follows.

(d) If Neither conclusion I nor II follows.

(e) If Both conclusions I and II follow.

49. Statements:

All Apple are Fruit.

All Orange are fruit.

Some Fruit are Tasty.

Some Mango Are not Tasty.

Conclusions:

I. All Apple being Tasty is possibility.

II. Some Orange are Apple.

(a) If Only conclusion I follows.

(b) If Only conclusion II follows.

(c) If Either conclusion I or II follows.

(d) If Neither conclusion I nor II follows.

(e) If Both conclusions I and II follow.

Ultra Practice Bundle PDF for All Bank Prelims Exams

50. Statements:

All Apple are Fruit.

All Orange are fruit.

Some Fruit are Tasty.

Some Mango Are not Tasty.

Conclusions:

I. All Mango are being Orange is possibility.

II. Some Fruit are being Mango is possibility.

(a) If Only conclusion I follows.

(b) If Only conclusion II follows.

(c) If Either conclusion I or II follows.

(d) If Neither conclusion I nor II follows.

(e) If Both conclusions I and II follow.

Solutions

Solution1:b) If Only conclusion II follows.

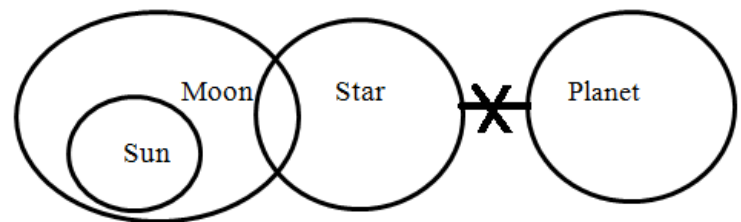
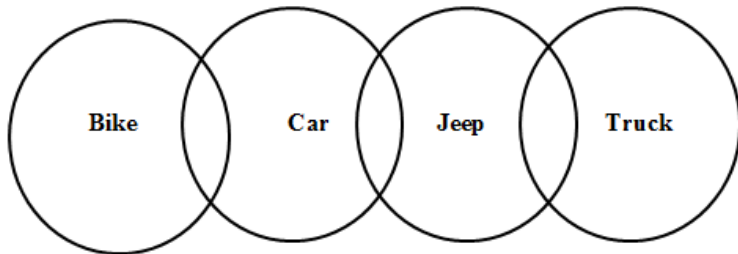

Solution4: e) If Both conclusions I and II follow.

Solution 2: a) If Only conclusion I follow.

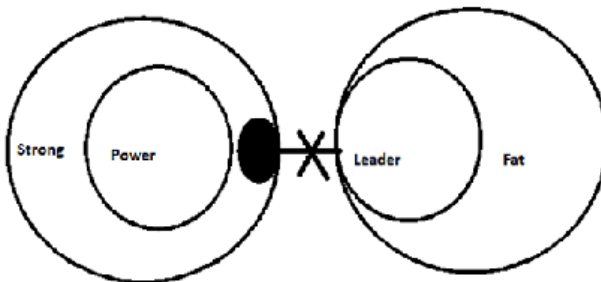

Solution 3:b) If Only conclusion II follow.



Ultra Practice Bundle PDF for All Bank Prelims Exams

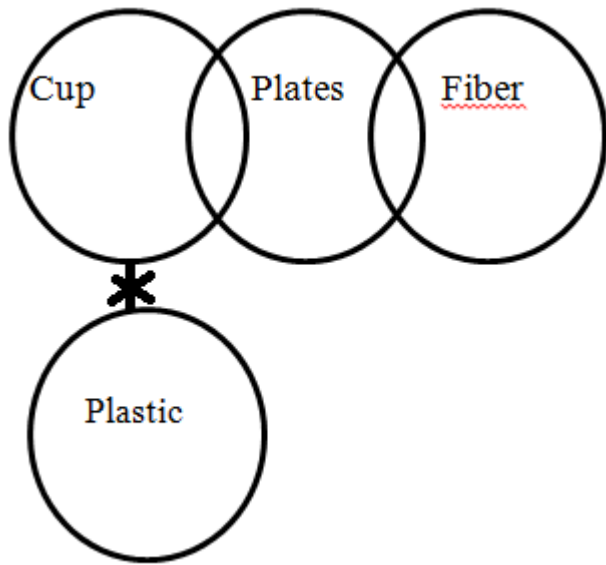

Solution5: d) Neither conclusion I nor II follows.

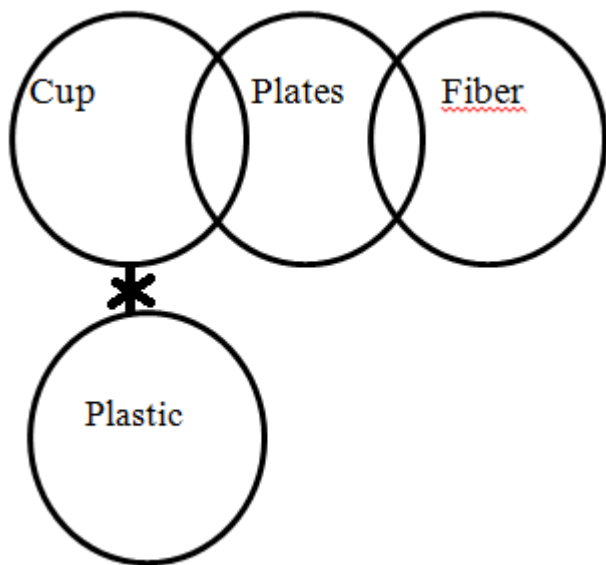

Solution6: d) If Neither conclusion I nor II follows.

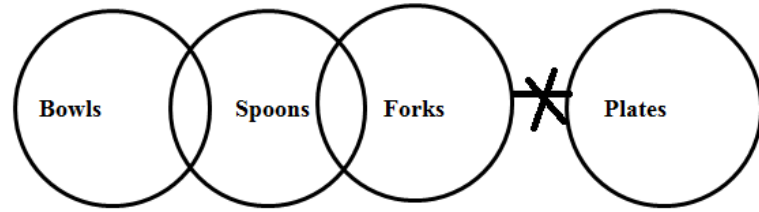

Solution7: b) If Only conclusion II follows.

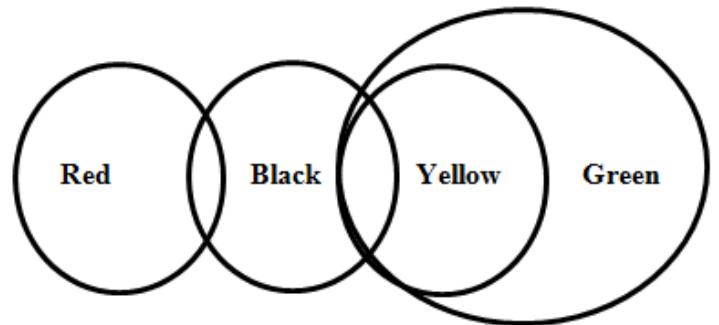

Solution8:a) If Only conclusion I follow.

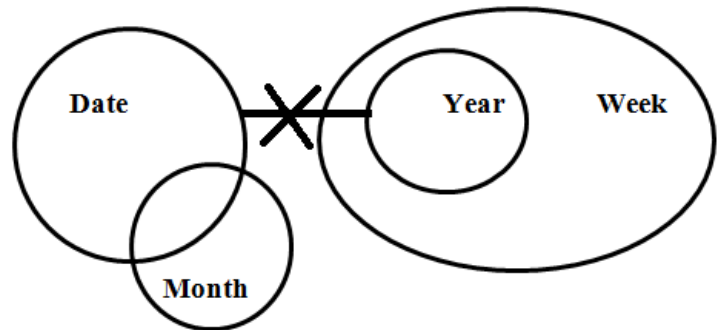

Solution9:d) If Neither conclusion I nor II follows.

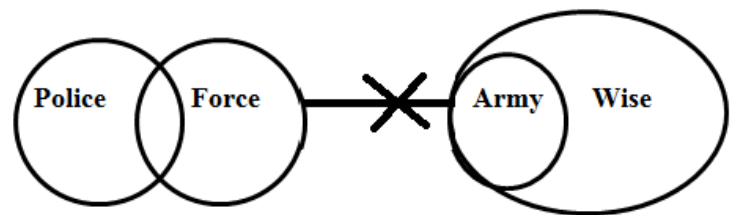



Ultra Practice Bundle PDF for All Bank Prelims Exams

Solution10:b) If Only conclusion II follows.

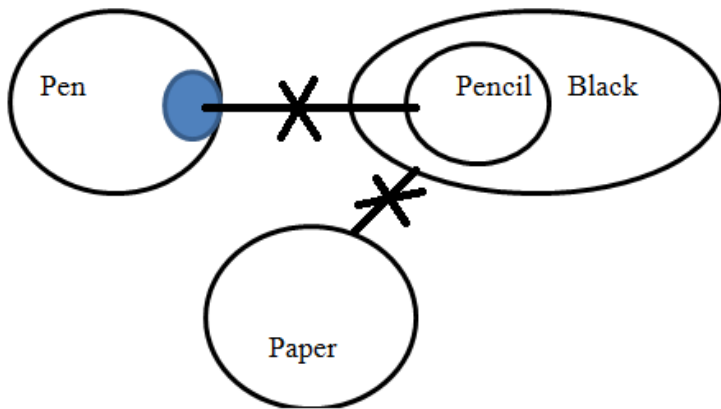

Solution11: e) If Both conclusions I and II follow.

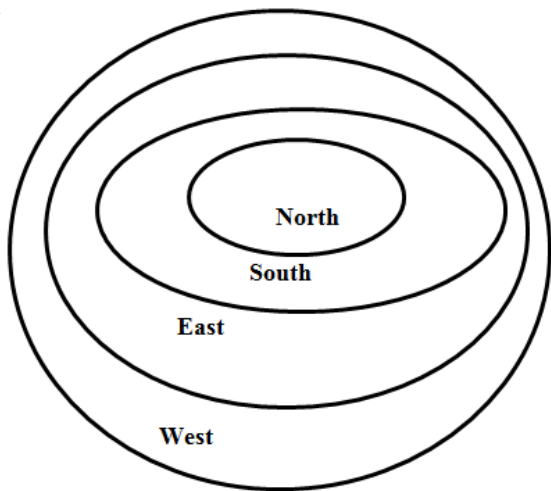

Solution12: b) If Only conclusion II follows.

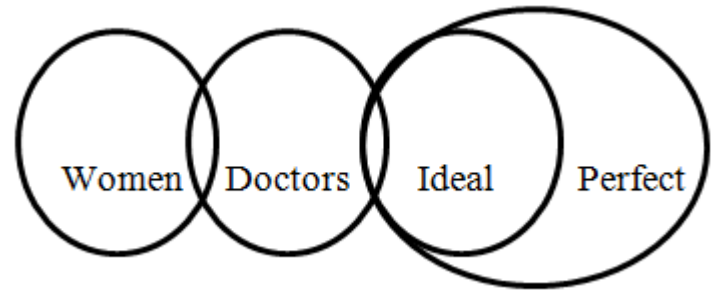

Solution13:e) If Both conclusions I and II follow.

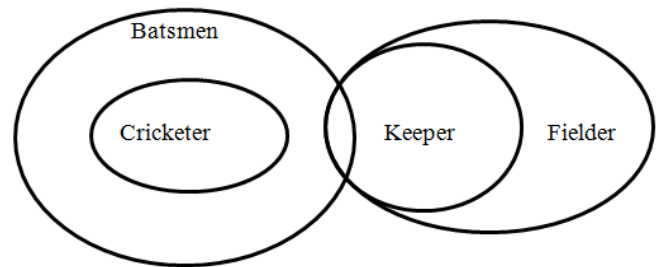

Solution14: d) If Neither conclusions I and II follow.

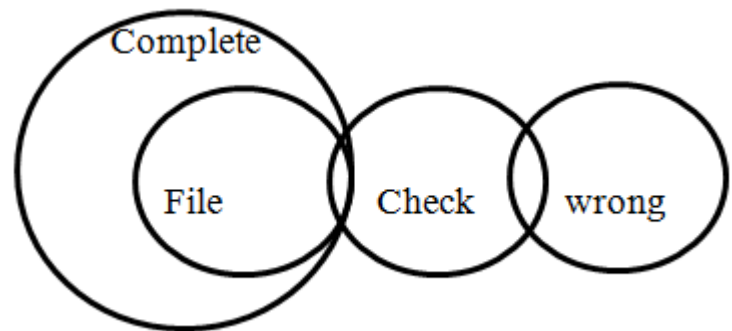

Solution15: a) If Only conclusion I follow.



Ultra Practice Bundle PDF for All Bank Prelims Exams

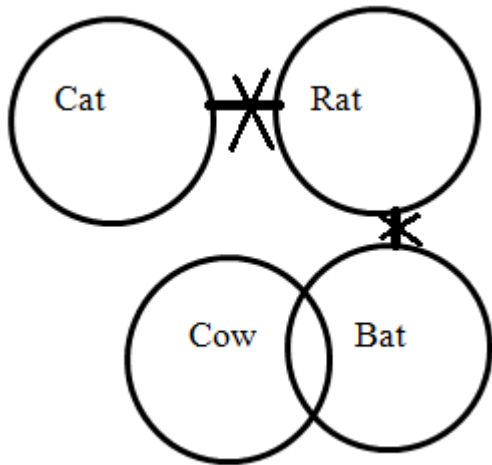

Solution16: If Both conclusions I and II follow.

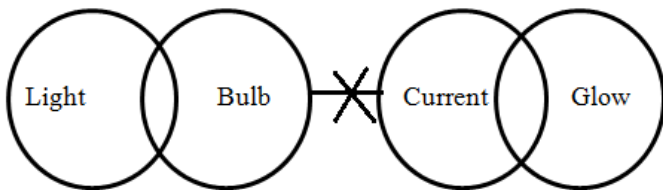

Solution17: d) If Neither conclusion I nor II follows.

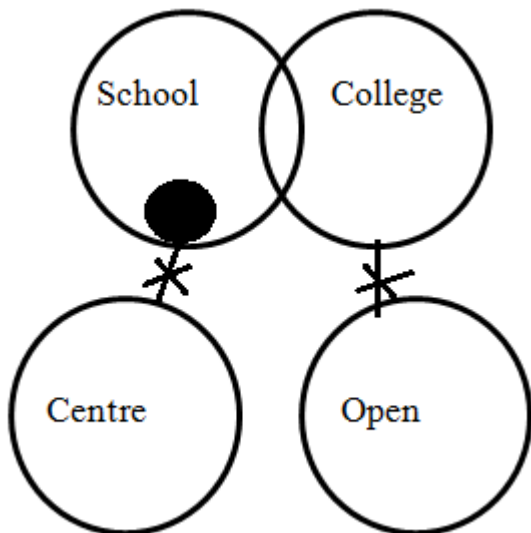

Solution18:d) If Neither conclusion I nor II follows.

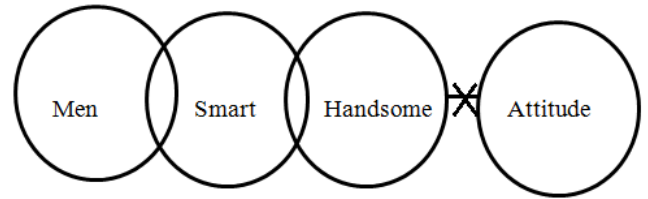

Solution19:b) If Only conclusion II follow.

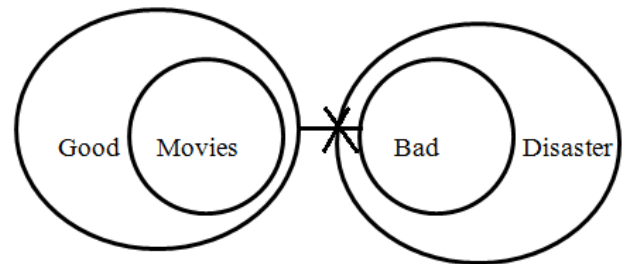

Solution20: b) If Only conclusion II follows.

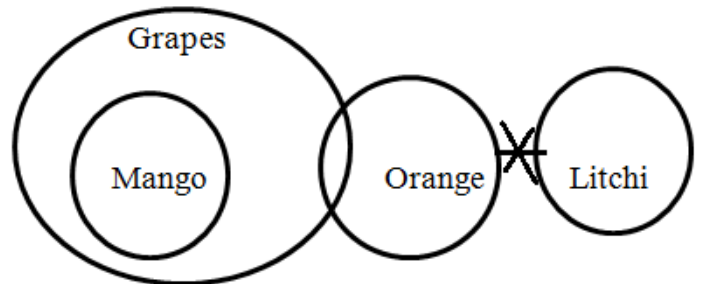

Solution21:e) If Both conclusions I and II follow.

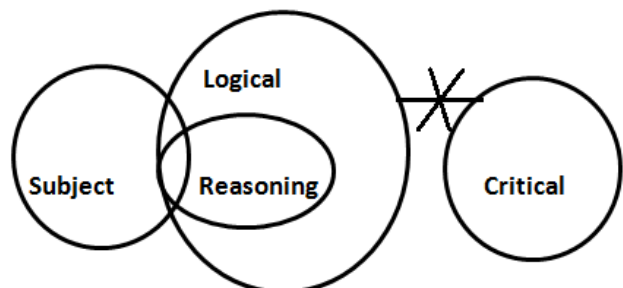

Solution22: d) If Neither conclusion I nor II follows.



Ultra Practice Bundle PDF for All Bank Prelims Exams

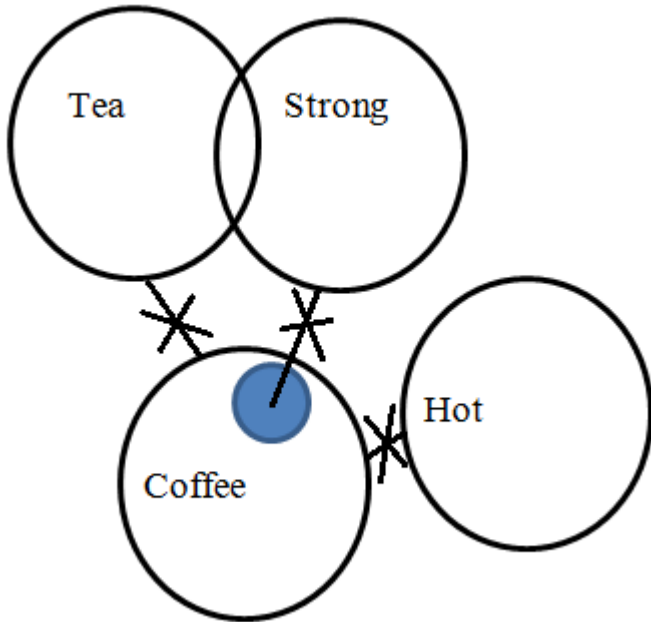

Solution23:e) If Both conclusion I and II follows.

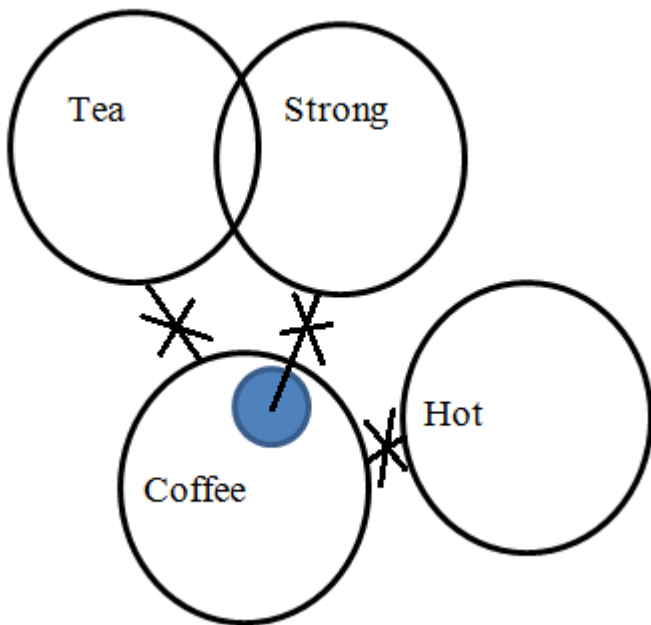

Solution24: c) If Either conclusion I or II follows.

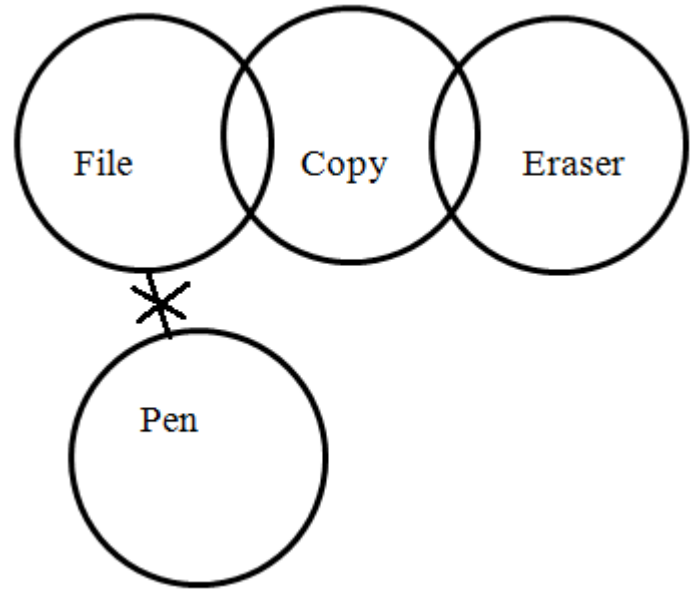

Solution25: a) If Only conclusion I follow.

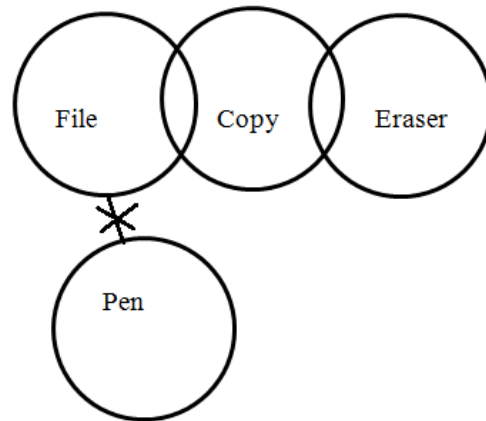

Solution26:a) If Only conclusion I follow.

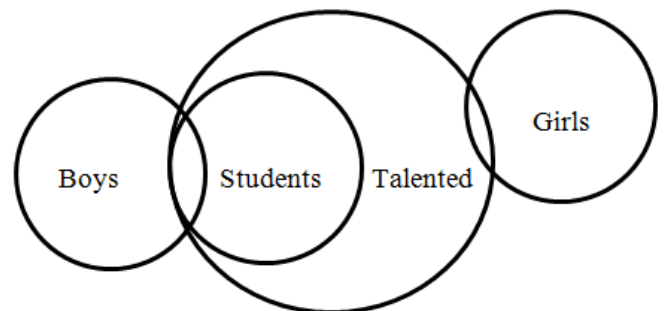

Solution27: b) If Only conclusion II follows.



Ultra Practice Bundle PDF for All Bank Prelims Exams

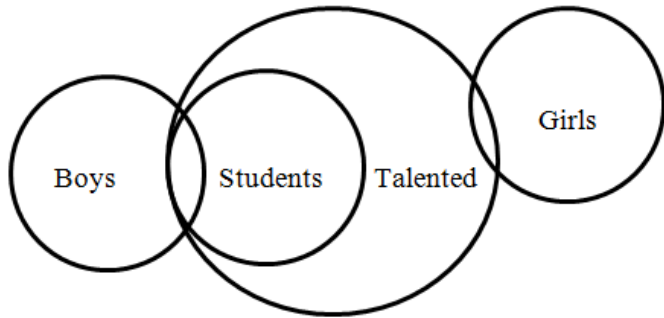

Solution 28: b) If Only conclusion II follows.

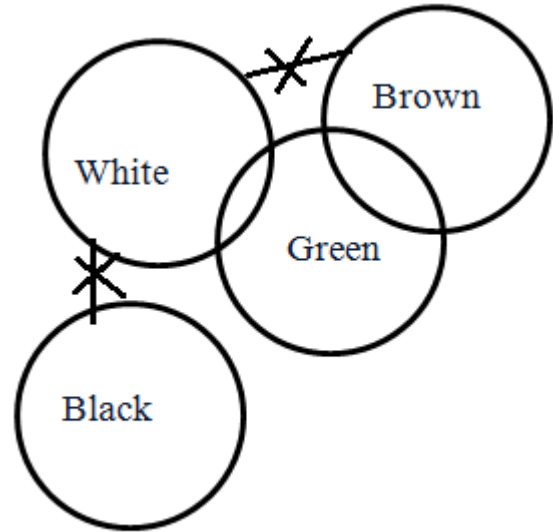

Solution 30: d) If Neither conclusion I nor II follows.

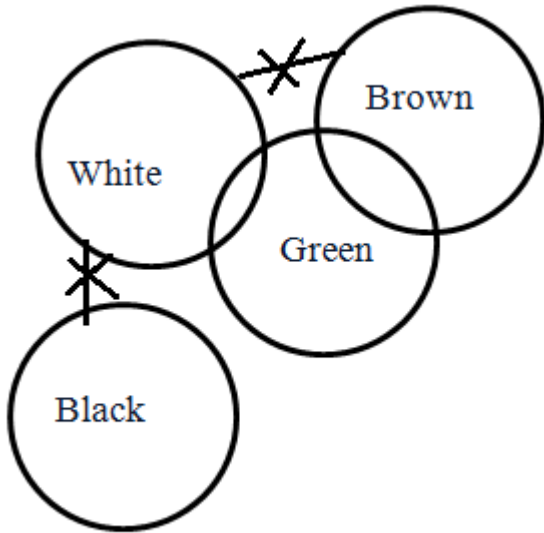

Solution 29: d) If Neither conclusion I nor II follows.

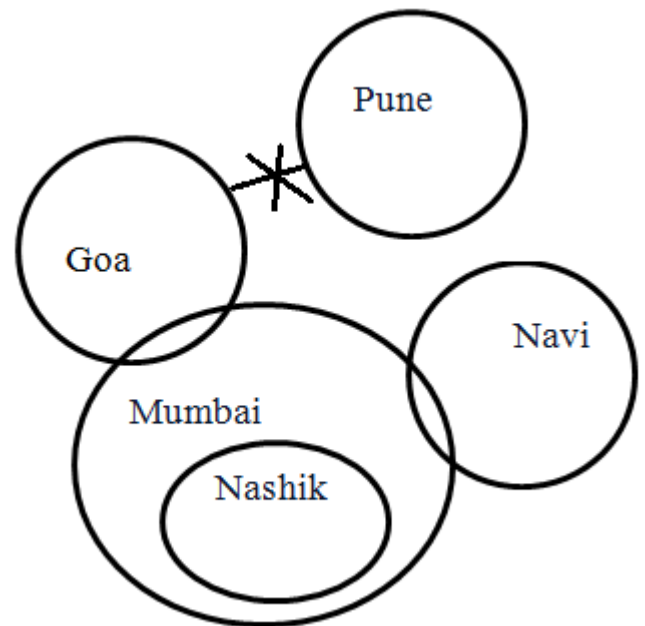

Solution 31: d) If Neither conclusion I nor II follows



Ultra Practice Bundle PDF for All Bank Prelims Exams

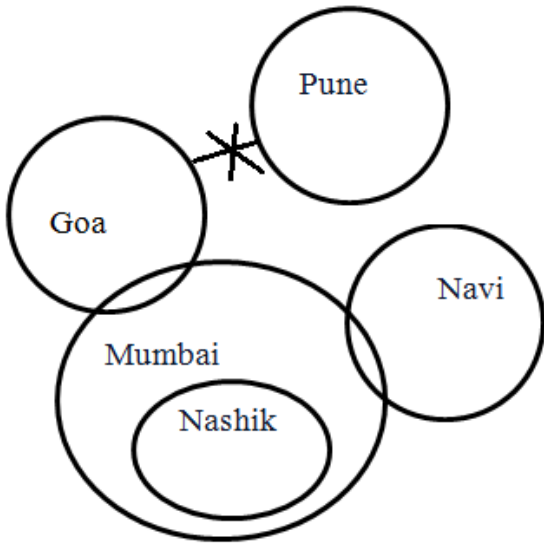

Solution32: b)If Only conclusion II follows.

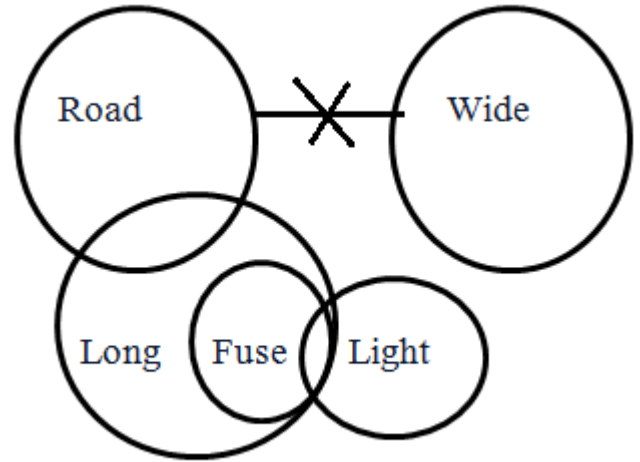

Solution34: b)If Only conclusion II follows.

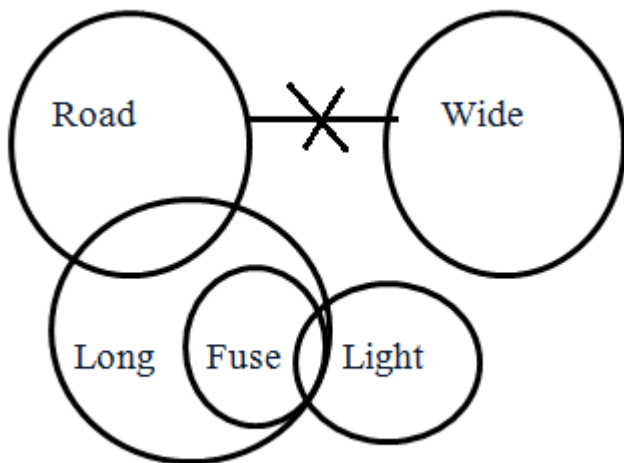

Solution33: e)If Both conclusions I and II follow.

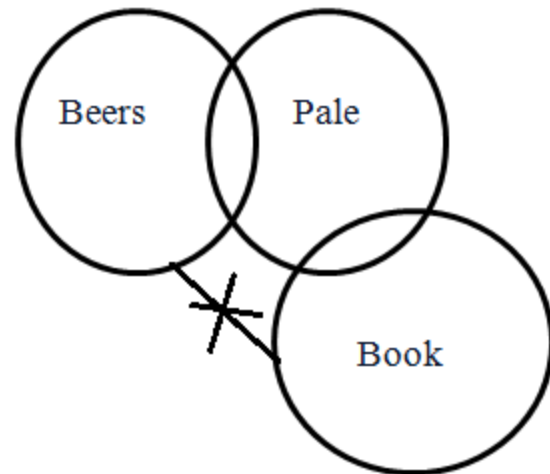

Solution35: d) If Neither conclusion I nor II follows.



Ultra Practice Bundle PDF for All Bank Prelims Exams

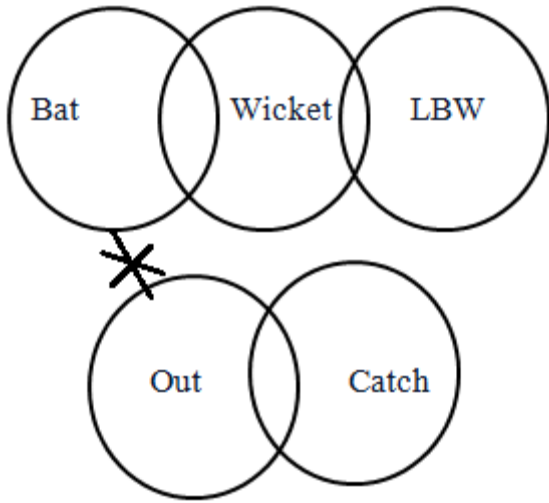

Solution36:e) If Both conclusions I and II follow.

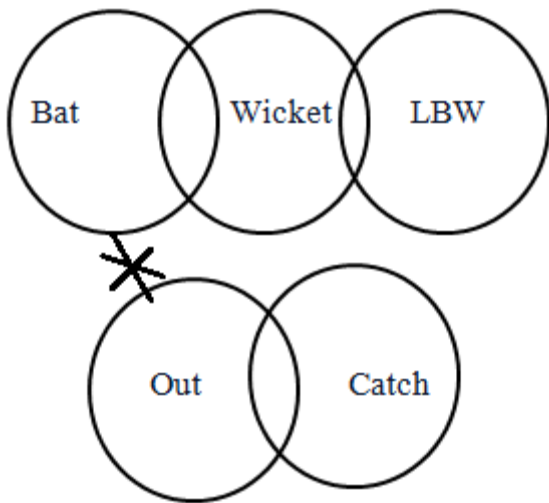

Solution37: b) If Only conclusion II follows.

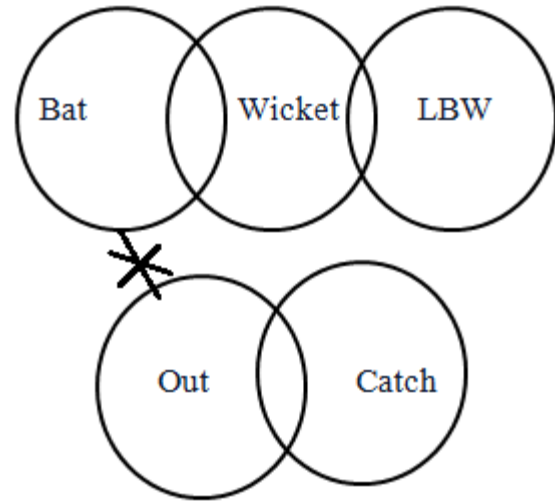

Solution38: e) If Both conclusions I and II follow.

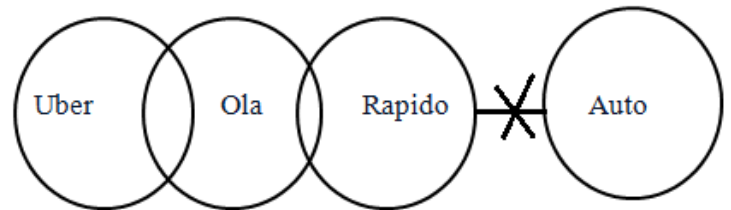

Solution39: d) If Neither conclusion I nor II follows.

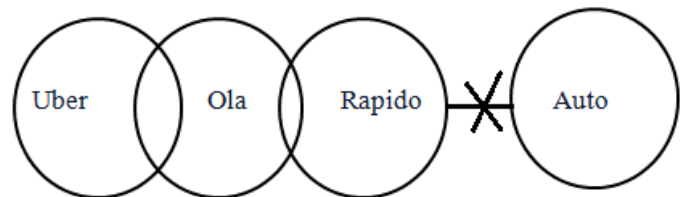

Solution40:d) If Neither conclusion I nor II follows.

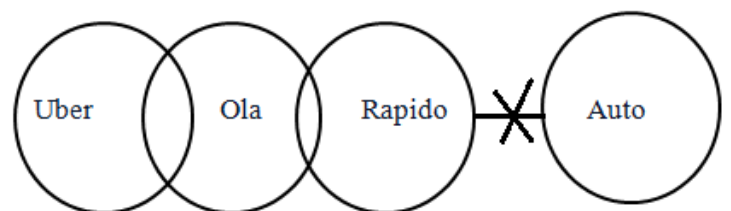



Ultra Practice Bundle PDF for All Bank Prelims Exams

Solution41:a) If Only conclusion I follow.

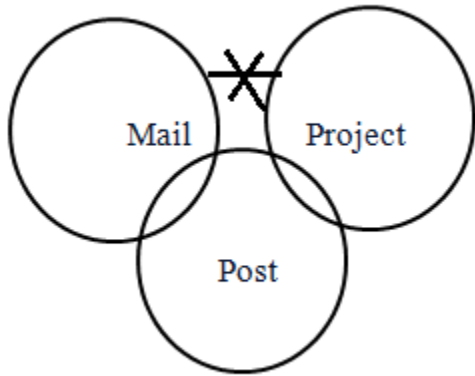

Solution42:b) If Only conclusion II follows.

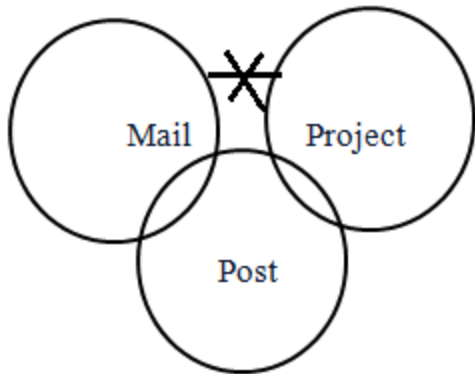

Solution43:d) If Neither conclusion I nor II follows.

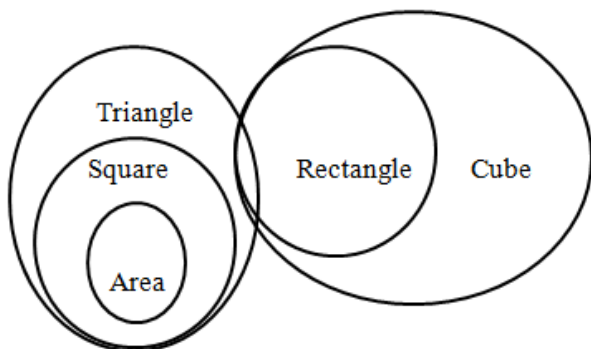

Solution44: b) If Only conclusion II follows.

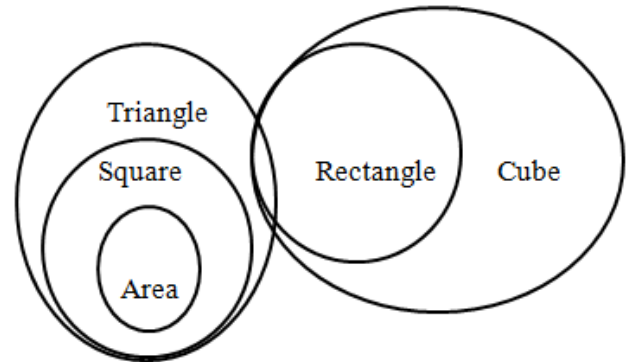

Solution45:a) If Only conclusion I follows.

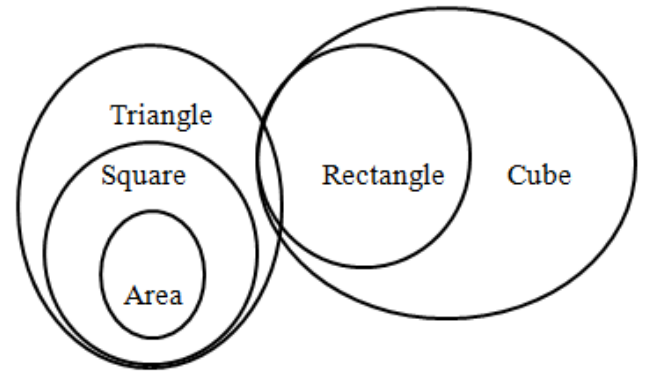

Solution46: a) If Only conclusion I follows.

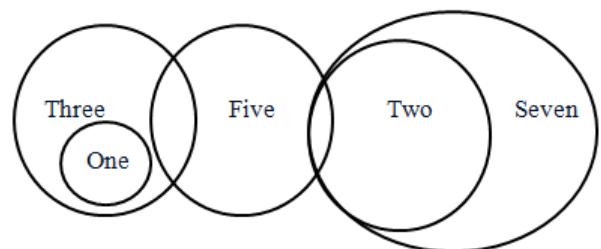

Solution47: b) If Only conclusion II follows.



Ultra Practice Bundle PDF for All Bank Prelims Exams

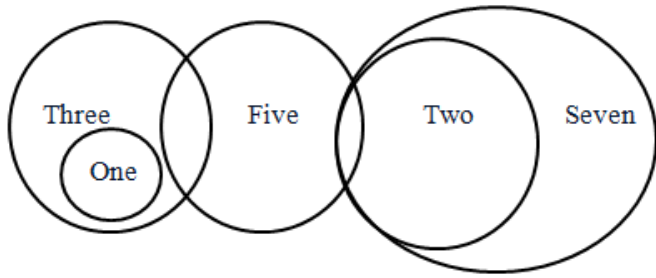

Solution48: e) If Both conclusions I and II follow.

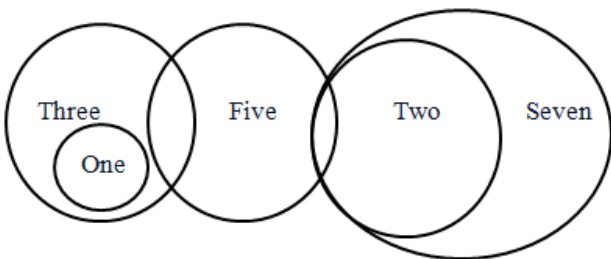

Solution50: e) If Both conclusions I and II follow.

Solution49: a) If Only conclusion I follow.

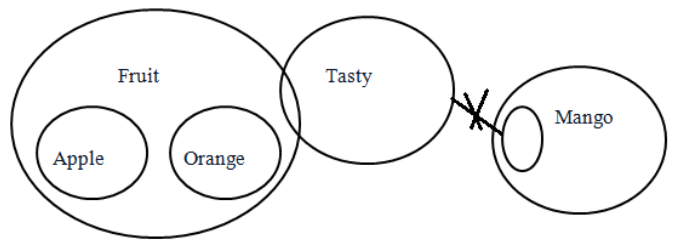
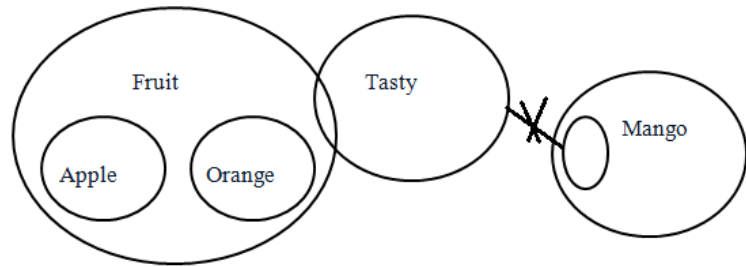

25. Conditional Coding

Directions (1 – 5): Consider the following data:

E	J	L	O	N	0	3	2	U	6	9	X	5
}	^	#	*	?	&	%	\$!	>	~		@

Each element is denoted by a symbol as shown above. Further, consider the given conditions and answer accordingly.

1. If the third element is odd and sixth element is a vowel, then both the elements should be coded as '!'.
2. If the second element is consonant and sixth element is also a consonant, then both the elements should be coded as the code of the second element.
3. If the fifth and sixth elements are odd, then the code for both the elements should be interchanged.

2. If the second element is consonant and sixth element is also a consonant, then both the elements should be coded as the code of the second element.

3. If the fifth and sixth elements are odd, then the code for both the elements should be interchanged.

1. 0XUN2L

a) %!?!\$|

b) &!?!\$|

Ultra Practice Bundle PDF for All Bank Prelims Exams

- c) &|>~\$|
 d) &|!|\$|
 e) None of these

2. L695UO

- a) #>%@!@
 b) #>!@!!
 c) #>!*\$
 d) #}!@~!
 e) None of these

3. 6XOE2J

- a) ||*}@|
 b) >|*}\$|
 c) @~*}\$|
 d) >^&}\$|
 e) None of these

4. 2XU359

- a) \$#!%%@
 b) &?!%~@
 c) #!\$~@
 d) \$!%~@
 e) None of these

5. L326JE

- a) &%\$>^>
 b) #^\$^^}
 c) #%\$>^}
 d) @%\$~^}

- e) None of these

Directions (6 – 10):In each question below is given a group of letters followed by four combinations of digits/symbols numbered (1), (2), (3) and (4). You have to find out which of the combinations correctly represents the group of letters based on the following coding system and the conditions that follow and mark the number of that combination as your answer. If none of combinations correctly represents the group of letters, mark (5) i.e. 'None of these' as your answer.

Digit/Symbol	9	@	2	4	\$	3	7	%	+	1	5	6	*	8	©
Letter	R	W	F	P	A	H	B	M	E	J	Q	I	U	N	T

Conditions:

- (i) If the first element is an even digit and the last element is a symbol, both are to be coded as the code for the even digit.
 (ii) If the first element is a symbol and the last element is an odd digit, their codes are to be interchanged.
 (iii) If the first element is an odd digit and the last element is an even digit, both are to be coded as the code for the odd digit.

6. 853©2+

- a) NQHTFE
 b) NQHTFN
 c) EQHTFN
 d) EQHTFE
 e) None of these

7. 4\$%3*6

- a) PAMHUI
 b) PAMHUP
 c) IAMHUP



Ultra Practice Bundle PDF for All Bank Prelims Exams

- d) IAMHUI
e) None of these

8. 9@\$3%6

- a) IWAHMI
b) RWAHMI
c) IWAHMR
d) RWHAMR
e) None of these

9. 728%9\$

- a) AFNMRB
b) BFNMRB
c) AFNMRA
d) BFNMRA
e) None of these

10. ©7+541

- a) TBEQPT
b) TBEQPJ
c) JBEQPT
d) JBEQPJ
e) None of these

Directions (11 – 15): Consider the following data and answer the questions based on the following conditions.

Digit	1	0	5	2	6	3	9	7	4	8
Symbol	@	A	#	C	K	\$	%	G	*	&

Conditions:

1. If the first digit is even and the last digit is odd, then both are to be coded as the code of the first digit.
2. If the first digit is odd and the last digit is even, then the codes for the first and the last digits are to be interchanged.
3. If the first as well as the last digit is odd, then both are to be coded as the code of the last digit.
4. If the first as well as the last digit is even, then both are to be coded as the code for the highest digit present in that particular group.

Each digit is denoted by a symbol as shown above. Further, consider the given conditions and answer the questions accordingly for a given number:

11. 243578

- a) &*\$G# &
b) &*\$#G&
c) C*\$#G&
d) C*\$#GC
e) &\$*#G&

12. 124567

- a) CC*#KC
b) GC*#KK
c) GC*K#G
d) GC*#KG
e) G*C#KG

13. 697845

- a) K%G&*K
b) G%G&*K
c) K%G*&K

Ultra Practice Bundle PDF for All Bank Prelims Exams

d) KG%&*K

e) #%G&*#

14. 987366

a) K&G\$KK

b) %&G\$K%

c) K&\$GK%

d) K&G\$%K

e) K&G\$K%

15. 928657

a) %C&K#%

b) GC&#KG

c) GC&K#G

d) G&CK#G

e) GC&#K%

Directions (16 – 20): Consider the following data:

Symb ol	1	A	U	6	T	2	F	G	4	I	O	5	P
Code	@	&	\$!	#	%	^	*	€	β	©	π	¥

Each element in the 1st row is denoted by a symbol in its respective row below it. Further, consider the given conditions and answer accordingly.

1. If the first element is a consonant and the last element is vowel, then code for both the elements are to be interchanged.

2. If the third element is consonant and the third element is preceded by an odd number then both are to be coded as %.

3. If the first element is odd and the last element is even, then code for the odd number must be replaced with the code for the even number.

16. T2G5PO

a) #%*π¥©

b) ©%*π¥#

c) ©*%π¥#

d) ©%π*¥#

e) None of these

17. U5G14F

a) \$%%@^€

b) €\$%%@€

c) \$%%@€^

d) \$π%@€^

e) None of these

18. 1IU5P6

a) !β\$π¥!

b) !β\$¥π@

c) !β\$¥π!

d) !β\$%¥!

e) None of these

19. 4PGIF2

a) €¥β*^%

b) ¥€*β^%

c) €%%β^%

d) €¥*β^%

e) None of these

20. T1FU2G

a) #%%\$%*

b) #@%\$%*

Ultra Practice Bundle PDF for All Bank Prelims Exams

- c) #^@\$%*
 d) #@^\$%*
 e) None of these

Directions (21 – 25): Study the following information carefully and answer the questions given below it.

Digits in the numbers are to be coded as follows

Digits	1	2	3	4	5	6	7	8	9	0
Letter/Symbol	A	@	B	D	#	%	E	G	&	\$

Conditions:

- i) If the first digit is an odd number and the last digit is an even number, then their codes are to be interchanged.
 ii) If the first digit is an even number and the last digit is an odd number then the third is to be the first digit.
 iii) If both the first and the last digits are an even number, then both are to be coded as the last digit.
 iv) If both the first and the last digits are an odd number, then both are to be coded as the first digit.

21. What is the code for “27138”?

- a) @EABG
 b) GEAB@
 c) GEABG
 d) @EAB@
 e) None of these

22. What is the code for “13054”?

- a) DB\$#D
 b) AB\$#A
 c) AB\$#D

- d) DB\$#A
 e) None of these

23. What is the code for “12345”?

- a) AD@B#
 b) A@BDA
 c) #@BD#
 d) #B@DA
 e) None of these

24. What is the code for “41025”?

- a) DA\$@#
 b) DA\$@D
 c) DAD@#
 d)#A\$@#
 e) None of these

25. What is the code for “32506”?

- a) % @#\$%
 b) %\$#@#B
 c) B@#\$B
 d) % @#\$B
 e) None of these

Directions (26 – 30): In each of the questions given below, a group of digits/letter is given followed by four combinations of symbols numbered (a), (b), (c) and (d). You have to find out which of the four combinations correctly represents the group of digits/letters based on the symbol codes and the conditions given below. If none of the four combinations represents the group of digits correctly, give (e) ‘None of these’ as the answer.

Ultra Practice Bundle PDF for All Bank Prelims Exams

Digit	U	P	S	1	0	Q	R	3	X	9	Z
Symbol	@	#	©	&	*	>	<	¥	^	!	+

Conditions for coding-

- (1) if the first element is odd number and last element is vowel then both are coded to be as the code of first element.
- (2) if first as well as last element is odd number then both are coded as the code of last element.
- (3) if first element is consonant and last element is vowel then code of first and last element are to be Interchanged.
- (4) if first element is consonant and last element is divisible by three then both are coded to be as @.

26. What is the code for 31OR9?

- a) !&*<!
- b) !*>!
- c) *©¥+!
- d) !@*<!
- e) None of these.

27. What is the code for 3PQZU?

- a) ¥>+¥
- b) ¥*<^*
- c) ¥#>+¥
- d) #¥>+¥
- e) None of these.

28. What is the code for Q9ZPU?

- a) @!+##>
- b) >!+##@
- c) @!¥+>

- d) ^@+!>
- e) None of these

29. What is the code for ROPZ9?

- a) @+##@
- b) *><¥^
- c) @*##+@
- d) !*##+@
- e) None of these

30. What is the code for RXPZQ?

- a) ^©##+>
- b) >+##^©
- c) <^##+>
- d) ©*@!+>
- e) None of these

Directions (31 – 35): Numerals are coded as given below and some conditions are given.

Accordingly, you have to find out which coding is correct.

4	6	7	8	1	3	5	0	9	2
#	B	M	%	E	\$	Z	P	&	Y

Conditions: -

- a) If first digit as well as last digit is odd then both will be coded as 'A'
- b) If first digit as well as last digit is even then both will be coded as '0'
- c) If first digit is even and last digit is odd, then the code will be interchanged



Ultra Practice Bundle PDF for All Bank Prelims Exams

d) If first digit is odd and last digit is even then both will be coded as the even number.

e) If the number starts or end with zero, then zero will be coded as ‘*’

31. 316726

a) BBEMY4

b) BEBM\$4

c) BEBMYB

d) BMBMY4

e) None of these

32. 276134

a) 0M0BE\$

b) 0MBE\$0

c) 0MBE#0

d) MB0#\$B

e) None of these

33. 097321

a) *&M\$YE

b) *MYE&B

c) EY\$M&*

d) \$EYMS*

e) None of these

34. 156587

a) AMB0%A

b) A\$B%SA

c) A%BEZA

d) AZBZ%A

e) None of these

35. 825763

a) #ZYNB%

b) YZM%#B

c) \$YZMB%

d) #YMZ%B

e) None of these

Directions (36 – 40): In each of the following questions given below, a word is given followed by four combinations of symbols and digits labeled A, B, C and D. You have to find out which of the following four combinations correctly represents the word based on the symbol codes and the conditions given below. If none of the combinations matches, choose ‘None of these’ as your answer.

Letter	Y	F	I	P	S	E	H	R	C	U	M	W	X	A	J	G	O
Code	7	@	5	4	1	#	6	\$	%	9	&	3	2	?	0	8	!

Condition 1: If first and last letter in a word are vowels then the code will be written in reversed order.

Condition 2: If there is no vowel in the word then code for the first three letters of the word will be written in reverse order.

Condition 3: If the letter on second and fourth position in the word is consonant then the codes of both them will be interchanged.

Note- If more than one condition satisfies the given word then condition 2 is to be applied only.

36. What would be the code of the word ‘UXAMF’?

a) 9@0?3

b) &9?25

Ultra Practice Bundle PDF for All Bank Prelims Exams

c) 9&?2@

d) 93&5?

e) None of these

37. What would be the code of the word 'GIFEM'?

a) 8@5&#

b) #58&@

c) 8@

d) 8@#&5

e) None of these

38. What would be the code of the word 'WJSFC'?

a) 781\$@

b) 08%1@

c) 03%1@

d) 103@%

e) None of these

39. What would be the code of the word 'AHIUE'?

a) #9?4\$

b) #956?

c) \$954?

d) #9?56

e) None of these

40. What would be the code of the word 'HCYUX'?

a) 6%792

b) #6%92

c) 6#%&2

d) 2%769

e) None of these

Directions (41 – 45): In this question is given a group of letters followed by five combinations of numbers/symbols codes. You have to find out which of the combinations correctly represents the group of letters based on the given coding system and the conditions and give that combination as your answer.

Letters	A	D	O	U	S	P	N	E	L	T	W	K	Z	Q
Number / Symbols Code	5	%	6	1	\$	8	&	4	7	#	@	2	+	3

Conditions :

(i) If the first element is a consonant and the last element is a vowel, then the consonant is to be coded as *

(ii) If both the first and last elements are vowels, then the last vowel is to be coded as the code for the fourth element.

(iii) If the group of elements does not contain any vowel, third element is to be coded as the code for the last element.

41. OTWDSA

a) 6#@%\$%

b) % @#%5%

c) 6#@%\$5

d) 6#@%\$@

e) 6#@5\$5

42. ENZQLA

a) 4&+373

Ultra Practice Bundle PDF for All Bank Prelims Exams

- b) 4&+575
 c) 4*+375
 d) 4&+375
 e) *&+373

43. KPELQU

- a) *84731
 b) 284731
 c) *84732
 d) 28473*
 e) *8473*

44. WTDKNP

- a) @#8&28
 b) @#%2&8
 c) @#%2&%
 d) @#%2&2
 e) @#82&8

45. KZLTDP

- a) 2+7#%7
 b) 2+8#%8
 c) *+7#%8
 d) #+82%8
 e) 2+7#%8

Directions (46 – 50): In this question is given a group of letters followed by five combinations of numbers / symbols codes. You have to find out which of the combinations correctly represents the group of letters based on the following coding system and the conditions and mark that combination as your answer.

Letters	D	N	W	A	S	E	K	T	O	L	P	U	Z	Q
Number/ Symbols Codes	4	%	\$	3	@	8	&	5	1	+	2	#	6	7

Conditions :

(Note: Counting of elements is done from left to right)

- If the first element is a vowel and the last element is a consonant, then all the vowels are to be coded as ©
- If both the first and last elements are vowels, then the first vowel is to be coded as the code for the third element
- If the group of elements does not contain any vowel, the codes for second and last element are to be interchanged

46. OZTENW

- a) ©65©S%
 b) ©658%\$
 c) 156©%\$
 d) ©65©%\$
 e) 165©%S

47. AZKEUS

- a) ©6&8©@
 b) ©6&©#@
 c) @6&©©3
 d) ©6&©@@
 e) ©6&©©@

48. STKPDW

- a) @\$2&45
 b) @\$&452
 c) @5&24\$

Ultra Practice Bundle PDF for All Bank Prelims Exams

d) @\$&245

e) &\$@245

49. EWDZQU

a) 4\$467#

b) 4S476#

c) 8S476#

d) 4\$867#

e) 8\$867#

50. LPZDNS

a) @246%+

b) +@6%42

c) @264%+

d) +@62%4

e) +@64%2

Answers with Explanation:

1. Answer: B)

By rule (2), If the second element is consonant and sixth element is consonant, then both the elements should be coded as the code of the second element.

the code should be: &!?\$|

2. Answer: B)

By rule (1), If the third element is odd and sixth element is vowel, then both the elements should be coded as '!'.

the code should be: #>!@!!

3. Answer: B)

By rule (2), If the second element is consonant and sixth element is consonant, then both the elements should be coded as the code of second element.

the code should be: >|*}\$|

4. Answer: D)

By rule (3), If the fifth and sixth elements are odd, then the code for both the elements should be interchanged.

the code should be: \$!%~@

5. Answer: C)

It follows none of the given rules, the code should be: #%\$>^}

6. Answer: B)

8	5	3	⊙	2	+
N	Q	H	T	F	E

Here condition (i) is applicable, hence the code is NQHTFN

7. Answer: A)

4	\$	%	3	*	6
P	A	M	H	U	I

8. Answer: E)

9	@	\$	3	%	6
R	W	A	H	M	I

Here condition (iii) is applicable, hence the code is RWAHMR

9. Answer: D)

7	2	8	%	9	\$
B	F	N	M	R	A

10. Answer: C)

⊙	7	+	5	4	1
T	B	E	Q	P	J

Ultra Practice Bundle PDF for All Bank Prelims Exams

Here condition (ii) is applicable, hence the code is JBEQPT

11. Answer: B)

By rule 4,

Highest number is 8 in that group so 2 and 8 will be coded as &.

4-*, 3-\$, 5-#, 7-G

So, the code is &*\$#G&.

12. Answer: D)

By rule 3,

1 and 7 will be code as G.

2-C, 4-*, 5-#, 6-K

So, the code is GC*#KG.

13. Answer: A)

By rule 1,

6 and 5 will be coded as K

9-%, 7-G, 8-&, 4-*

So, the code is K%G&*K.

14. Answer: E)

By rule 2,

Code of 9 and 6 will be interchanged.

8-&, 7-G, 3-\$, 6-K

So, the code is K&G\$K%.

15. Answer: C)

By rule 3,

9 and 7 will be coded as G

2-C, 8-&, 6-K, 5-#

So, the code is GC&K#G

16. Answer: B)

By rule no. 1

First element is a consonant and last element is vowel so code for both the elements should be interchanged.

T	2	G	5	P	O
©	%	*	π	¥	#

17. Answer: C)

By rule no. 2

Third element is a consonant and the third element preceded by an odd number then both should be coded as %.

U	5	G	1	4	F
\$	%	%	@	€	^

18. Answer: A)

By rule no. 3

First element is an odd number and last element is even, then code for the odd number must be replaced with the code for the even number.

1	I	U	5	P	6
!	β	\$	Π	¥	!

19. Answer: D)

No Rule follows. Code will remain unchanged.

4	P	G	I	F	2
€	¥	*	B	^	%

20. Answer: A)

By rule no. 2

Ultra Practice Bundle PDF for All Bank Prelims Exams

Third element is a consonant and the third element preceded by an odd number. so both should be coded as %.

T	1	F	U	2	G
#	%	%	\$	%	*

21. Answer: c

It follows condition (iii). So, '27138' can be coded as 'GEABG'

22. Answer: d

It follows condition (i). So, '13054' can be coded as 'DB\$#A'

23. Answer: b

It follows condition (iv). So, '12345' can be coded as 'A@BDA'

24. Answer: E

It follows condition (ii). So, '41025' can be coded as '\$A\$@#'

25. Answer: d

It follows condition (i). So, '32056' can be coded as '%@#B\$'

26. Answer: A)

It follows condition (ii). So '31OR9' can be coded as '!&*<!'.

27. Answer: C)

It follows condition (i). So, '3PQZU' can be coded as '¥#>+¥'

28. Answer: A)

It follows condition (iii). So, 'Q9ZPU' can be coded as '@!+##>'

29. Answer: C)

It follows condition (iv). So, 'ROPZ9' can be coded as '@*##+@'

30. Answer: C)

No Rule follows. Code will remain unchanged.

So, 'RXPZQ' can be coded as '<^##+>'

31. Answer: C)

First number is odd and last number is even, so it will be coded as even number

32. Answer: B)

condition b follow, so both will be coded as 0

33. Answer: A)

condition e follow, the number starts with 0, so zero will be coded as *

34. Answer: D)

condition a follow, so both the first and last digit will be coded as A

35. Answer: C)

condition c follows, so codes will be interchanged

36. Answer: C)

Here, we can see that letters on second and fourth position in the word 'UXAMF' are consonants. Therefore, Condition 3 can be applied:

Then, the code of the word 'UXAMF' is '92?&@' after applying the condition '9&?2@'.

37. Answer: E)

Here, we can see that there is no condition applicable in this case. So, we can write the code of 'GIFEM' directly from the given table:

Then, the code of the word 'GIFEM' is '85@##&'.

38. Answer: D)

Ultra Practice Bundle PDF for All Bank Prelims Exams

Here, we can see that there is no vowel in the word 'WJSFC'. Therefore, Condition 2 can be applied.

Also, the second and fourth letter is a consonant, thus Condition 4 is also applicable.

But in such a case only condition 2 is to be applied.

Thus, the code of the word 'WJSFC' is '301@%' after reversing codes for the first three letters '103@%'.

39. Answer: B)

Here, we can see that first and last letter in the word 'AHIUE' are vowels. Therefore, Condition 1 can be applied:

Then, the code of the word 'AHIUE' is '?659#' after reversing the code '#956?'.

40. Answer: A)

Here, we can see that there is no condition applicable in this case. So, we can write the code of 'HCYUX' directly from the given table:

Then, the code of the word 'HCYUX' is '6%792'.

41. Answer: A)

Condition (ii) is applicable

Then the code of the word OTWDSA is 6#@%\$%

42. Answer: A)

Condition (ii) is applicable

Then the code of the word ENZQLA is 4&+373

43. Answer: A)

Condition (i) is applicable

Then the code of the word KPELQU is *84731

44. Answer: E)

Condition (iii) is applicable

45. Answer: B)

Condition (iii) is applicable

Then the code of the word KZLTDP is 2+8#%8

46. Answer: D)

Condition (i) is applicable

Then the code of the word OZTENW is ©65©%\$

47. Answer: E)

Condition (i) is applicable

Then the code of the word AZKEUS is ©6&©©@

48. Answer: D)

Condition (iii) is applicable

Then the code of the word STKPDW is @\$&245

49. Answer: A)

Condition (ii) is applicable

Then the code of the word EWDZQU is 4\$467#

50. Answer: E)

Condition (iii) is applicable

Then the code of the word LPZDNS is +@64%2

Quants Topic

1. Approximation- RRB Assistant Prelims

Directions (1-50) What approximate value will come in place of the question mark (?) in the following question? (Note: You are not expected to calculate the exact value.)

1. $(15.25^2 \div 2.98) \times 4.04 = ? \times 14.69$

- a) 20
- b) 80
- c) 150
- d) 320
- e) 240

2. $(449.89 \div 25.15) + 111.78 = ? \times 4.99$

- a) 5
- b) 65
- c) 26
- d) 100
- e) 150

3. $43.84\% \text{ of } 499.68 + 1499.87 = ? \times 15.78$

- a) 350
- b) 108
- c) 200
- d) 180
- e) 240

4. $(224.98 + 325.29) \div 24.94 = ? \times 1.87$

- a) 158
- b) 94

c) 72

d) 46

e) 11

5. $54.96\% \text{ of } 22.07 \div 0.02 = ?^2 \times 4.999$

a) 13

b) 7

c) 11

d) 10

e) 21

6. $\sqrt{3036} - \sqrt{325} - \sqrt{960} = \sqrt{?}$

a) 16

b) 36

c) 49

d) 25

e) 64

7. $7.99 \times 4.07 \div 15.96 = ?^2$

a) 4

b) 2

c) 8

d) 6



Ultra Practice Bundle PDF for All Bank Prelims Exams

e) $\sqrt{2}$

8. $\frac{5}{6}$ of 311 \div $\frac{1}{4}$ of 1042 = ?

- a) 1
- b) 12
- c) 3
- d) 0
- e) 2

9. $(15.99)^2 \div 8.03 - 8.97 \times 8.08 = ? -56.89$

- a) 21
- b) 17
- c) 26
- d) 32
- e) 27

10. 24.98% of 239.89 + 29.83% of 299.98 = ?

- a) 120
- b) 80
- c) 170
- d) 180
- e) 150

11. $?^2 \times 8.95 = 199.89 \times 17.93$

- a) 16
- b) 20
- c) 10
- d) 12
- e) 15

12. $7.98 \times 3.94 + 2.98 \times 35.98 \div 5.96 = ?$

a) 40

- b) 36
- c) 50
- d) 46
- e) 56

13. 29.98% of 249.98 \div 24.98 \div 2.98 = ?

- a) 3
- b) 5
- c) 9
- d) 11
- e) 1

e) 1

14. 19.89% of 149.98 + $\sqrt[3]{1727.98} - 5.95^2 = ?$

- a) 12
- b) 6
- c) 16
- d) 22
- e) 2

15. $(109.95 \times 2.97) \div (3.14 \times 4.95) = ?$

- a) 12
- b) 26
- c) 36
- d) 22
- e) 48

16. $13.005 \times 7.02 + (84.99)^2 \times 10.99 = (?)$

- a) 79966
- b) 79866

Ultra Practice Bundle PDF for All Bank Prelims Exams

c) 79666

d) 79566

e) 79366

17. 102.91% of $640.02 - 3/7\%$ of $6300.102 + 12.001 =$
(?)

a) 664

b) 964

c) 864

d) 644

e) 744

18. $1215.034 \div 26.98 \div \sqrt{82} = ?$

a) 50

b) 2

c) 5

d) 120

e) 500

19. 24.95% of $5690 + 15.09 \times 1200 \div 3.96 = ?$

a) 5922.5

b) 5912.5

c) 5932.5

d) 5902.5

e) 5942.5

20. $46.786 \times 0.986 + 64.372 \times 0.986 - 7.03 \times 5.985 = ?$

a) 75

b) 69

c) 86

d) 102

e) 72

21. $11.95 \times 17.98 \div 5.96 + 24.21 = ?$

a) 40

b) 80

c) 70

d) 60

e) 50

22. $27.98 - ? + 17.99 + (9.09)^2 = 109.98$

a) 11

b) 13

c) 8

d) 17

e) 21

23. 59.98% of $499.94 + 44.95\%$ of $799.98 = ?$

a) 660

b) 620

c) 520

d) 560

e) 580

24. $(2/5 \text{ of } 224.98) \times 11.97 \div 4.98 = ?$

a) 196

b) 216

c) 208

d) 202

e) 192

25. $(\sqrt{35.94 + 2.93})^3 = 649.97 + ?$



Ultra Practice Bundle PDF for All Bank Prelims Exams

a) 79

b) 71

c) 85

d) 91

e) 89

26. $(23.89 \div 6.06 \times 31.98) \div 7.94 = ?$

a) 22

b) 28

c) 18

d) 12

e) 16

27. $4.96^2 \times 6.93^2 = (?)^2 + 135.98$

a) 23

b) 31

c) 33

d) 29

e) 34

28. $\sqrt[3]{511.98} \times \sqrt{35.96} - ? \times 15.98 = 31.98$

a) 3

b) 6

c) 9

d) 1

e) 11

29. $53.92 \times 35.96 \div 2.92^3 + 7.94 = ?$

a) 75

b) 80

c) 70

d) 72

e) 88

30. $\sqrt{1023.99} + \sqrt{483.94} + 399.97 \times 49.95\% = ?$

a) 216

b) 228

c) 234

d) 246

e) 254

31. $29.98\% \text{ of } (24.98 \times 11.89) = ? + 39.99$

a) 45

b) 50

c) 20

d) 40

e) 35

32. $34.98\% \text{ of } 599.99 + 44.95\% \text{ of } 399.99 = ?$

a) 260

b) 410

c) 370

d) 390

e) 330

33. $\sqrt{440.91} - \sqrt{360.99} + \sqrt{624.94} = ?^3$

a) 2

b) 4

c) 7

d) 5



Ultra Practice Bundle PDF for All Bank Prelims Exams

e) 3

34. $\{64.98 - (55.96 - 47.98 \div 7.9 \times 5.98)\} = ?$

a) 45

b) 35

c) 40

d) 30

e) 25

35. $62.91 \div (2.93)^2 \times 3.98 - 16.97 = \sqrt{?}$

a) $\sqrt{11}$

b) 169

c) $\sqrt{13}$

d) 121

e) 100

36. $39.98\% \text{ of } 119.67 + (2.25 \times 24.89) = ? - 39.88$

a) 300

b) 180

c) 140

d) 100

e) 240

37. $(12.69 \times 15.15) \div 4.95 + 121.21 = ?$

a) 160

b) 120

c) 80

d) 200

e) 240

38. $(124.35 + 235.78) \div 17.89 = ? \times 4.23$

a) 180

b) 5

c) 60

d) 240

e) 120

39. $?^2 - 23.68\% \text{ of } 499.84 = \sqrt{9999} + 68.76$

a) 32

b) 17

c) 2

d) 52

e) 74

40. $(14.78^2 + 364.89) \div 5 = ? - 122.22$

a) 240

b) 180

c) 320

d) 90

e) 280

41. $17.89\% \text{ of } 249.87 + 194.95 = ? \times 11.78$

a) 90

b) 72

c) 2

d) 45

e) 20

42. $(419.78 \div 34.67) \times 4.99 = ? - 139.98$

a) 450

b) 320



Ultra Practice Bundle PDF for All Bank Prelims Exams

c) 240

d) 200

e) 120

43. 24.99% of 799.99 + 44.99% of 399.99 = ?

a) 280

b) 320

c) 420

d) 380

e) 480

44. $(23.98 + 35.96 \times 3.96) \div 11.98 = ?$

a) 22

b) 18

c) 8

d) 26

e) 14

45. $14.94 \times 77.95 \div 12.95 - 89.99 = ?$

a) 10

b) -10

c) 5

d) 0

e) -5

46. $[(2.98^2 + 5.95^2) \times 6.98] \div 14.99 = ?$

a) 11

b) 21

c) 33

d) 23

e) 14

47. $429.99 - 19.98 \times 5.98 + 3.97^3 - 12.98 = ?^2$

a) 22

b) 26

c) 32

d) 17

e) 19

48. $487.99 - 319.99 = 317.98 - 5^2 \times ?$

a) 10

b) 15

c) 8

d) 3

e) 6

49. $79.99\% \text{ of } 599.99 \div 11.92 - 39.99 + \sqrt{483.94} = ?$

a) 22

b) 32

c) 26

d) 36

e) 42

50. $563.94 \div 5.96 + 25.99 = 239.99 \div ?$

a) 4

b) 6

c) 2

d) 8

e) 12



Ultra Practice Bundle PDF for All Bank Prelims Exams

Solution with Explanation

1. Answer: A)

$$(15.25^2 \div 2.98) \times 4.04 = ? \times 14.69$$

$$(15^2 \div 3) \times 4 \sim ? \times 15$$

$$? \sim (225 \div 3) \times (4/15)$$

$$? \sim 20$$

2. Answer: C)

$$(449.89 \div 25.15) + 111.78 = ? \times 4.99$$

$$(450 \div 25) + 112 \sim ? \times 5$$

$$? \sim 130 \div 5$$

$$? \sim 26$$

3. Answer: B)

$$43.84\% \text{ of } 499.68 + 1499.87 = ? \times 15.78$$

$$44\% \text{ of } 500 + 1500 \sim ? \times 16$$

$$? \sim (0.44 \times 500 + 1500) \div 16$$

$$? \sim 107.5$$

$$? \sim 108$$

4. Answer: E)

$$(224.98 + 325.29) \div 24.94 = ? \times 1.87$$

$$(225 + 325) \div 25 \sim ? \times 2$$

$$550 \div 25 \sim ? \times 2$$

$$? \sim 22 \div 2$$

$$? \sim 11$$

5. Answer: C)

$$?^2 \approx \frac{55}{100} \times 22 \times \frac{100}{2} \times \frac{1}{5}$$

$$?^2 \approx 121$$

$$? \approx 11$$

6. Answer: B)

$$\sqrt{?} \approx \sqrt{3025} - \sqrt{324} - \sqrt{961}$$

$$\sqrt{?} \approx 55 - 18 - 31$$

$$\sqrt{?} \approx 6$$

$$? \approx 36$$

7. Answer: E)

$$8 \times 4 \times \frac{1}{16} \approx ?^2$$

$$?^2 \approx 2$$

$$? \approx \sqrt{2}$$

8. Answer: A)

$$\frac{5}{6} \times 312 + \frac{1}{4} \times 1042 \approx ?$$

$$? \approx \frac{260}{260.5}$$

$$? \approx 1$$

9. Answer: B)

$$? \approx 16 \times 16 \times \frac{1}{8} - 9 \times 8 + 57$$

$$? \approx 32 - 72 + 57$$

$$\Rightarrow ? \approx 17$$

10. Answer: E)

$$24.98\% \text{ of } 239.89 + 29.83\% \text{ of } 299.98 = ?$$

$$\Rightarrow 25\% \text{ of } 240 + 30\% \text{ of } 300 = ?$$

$$\Rightarrow 240 \times (25/100) + 300 \times (30/100) = ?$$

$$\Rightarrow 60 + 90 = ?$$

$$\Rightarrow 150 = ?$$

11. Answer: B)



Ultra Practice Bundle PDF for All Bank Prelims Exams

$$?^2 \times 8.95 = 199.89 \times 17.93$$

$$\Rightarrow ?^2 \times 9 = 200 \times 18$$

$$\Rightarrow ?^2 \times 9 = 200 \times 18$$

$$\Rightarrow ?^2 \times 9 = 3600$$

$$\Rightarrow ?^2 = 3600/9$$

$$\Rightarrow ?^2 = 400$$

$$\Rightarrow ? = 20$$

12. Answer: C)

$$7.98 \times 3.94 + 2.98 \times 35.98 \div 5.96 = ?$$

$$\Rightarrow 8 \times 4 + 3 \times 36 \div 6 = ?$$

$$\Rightarrow 8 \times 4 + 3 \times 6 = ?$$

$$\Rightarrow 32 + 18 = ?$$

$$\Rightarrow ? = 50$$

13. Answer: E)

$$29.98\% \text{ of } 249.98 \div 24.98 \div 2.98 = ?$$

$$\Rightarrow 30\% \text{ of } 250 \div 25 \div 3 = ?$$

$$\Rightarrow 75 \div 25 \div 3 = ?$$

$$\Rightarrow 3 \div 3 = ?$$

$$\Rightarrow ? = 1$$

14. Answer: B)

$$19.89\% \text{ of } 149.98 + \sqrt[3]{1727.98} - 5.952 = ?$$

$$\Rightarrow 20\% \text{ of } 150 + \sqrt[3]{1728} - 62 = ?$$

$$\Rightarrow 30 + 12 - 36 = ?$$

$$\Rightarrow 42 - 36 = ?$$

$$\Rightarrow 6 = ?$$

15. Answer: D)

$$(109.95 \times 2.97) \div (3.14 \times 4.95) = ?$$

$$\Rightarrow (110 \times 3) \div (3 \times 5) = ?$$

$$\Rightarrow 330 \div 15 = ?$$

$$\Rightarrow 22 = ?$$

16. Answer: D)

$$\Rightarrow 13.005 \times 7.02 + (84.99)^2 \times 10.99 = (?)$$

Approximating the value to the nearest integer:

$$\Rightarrow 13 \times 7 + 85^2 \times 11 = (?)$$

$$\Rightarrow 91 + 79475 = (?)$$

$$(?) = 79566$$

17. Answer: D)

$$\Rightarrow 102.91\% \text{ of } 640.02 - 3/7 \% \text{ of } 6300.102 + 12.001 = (?)$$

Approximating the value to the nearest integer:

$$\Rightarrow 103\% \text{ of } 640 - 3/7\% \text{ of } 6300 + 12 = (?)$$

$$(?) \approx 659 - 27 + 12 = 644$$

18. Answer: C)

$$\Rightarrow 1215.034 \div 26.98 \div \sqrt{82} = ?$$

Approximating the values to the nearest integer:

$$\Rightarrow 1215 \div 27 \div \sqrt{81} = ?$$

$$\Rightarrow 1215 \div 27 \div 9 = ?$$

$$\Rightarrow 45/9 = ?$$

$$\Rightarrow ? = 5$$

19. Answer: A)

$$24.95\% \text{ of } 5690 + 15.09 \times 1200 \div 3.96 = ?$$

Taking their approx. values



Ultra Practice Bundle PDF for All Bank Prelims Exams

$$\Rightarrow 25\% \text{ of } 5690 + 15 \times 1200 \div 4 = ?$$

$$\Rightarrow 1422.5 + 15 \times 300 = ?$$

$$\Rightarrow ? = 1422.5 + 4500$$

$$\therefore ? = 5922.5$$

20. Answer: B))

$$46.786 \times 0.986 + 64.372 \times 0.986 - 7.03 \times 5.985 = ?$$

$$\Rightarrow 47 \times 1 + 64 \times 1 - 7 \times 6 = ?$$

$$\Rightarrow 47 + 64 - 42 = ?$$

$$\Rightarrow 111 - 42 = ?$$

$$\Rightarrow 69 = ?$$

21. Answer: D)

$$11.95 \times 17.98 \div 5.96 + 24.21 = ?$$

$$\Rightarrow 12 \times 18 \div 6 + 24 = ?$$

$$\Rightarrow 12 \times 3 + 24 = ?$$

$$\Rightarrow 36 + 24 = ?$$

$$\therefore ? = 60$$

22. Answer: D)

$$27.98 - ? + 17.99 + (9.09)^2 = 109.98$$

$$\Rightarrow 28 - ? + 18 + (9)^2 = 110$$

$$\Rightarrow 28 - ? + 18 + 81 = 110$$

$$\Rightarrow 28 + 18 + 81 - 110 = ?$$

$$\Rightarrow 127 - 110 = ?$$

$$\Rightarrow ? = 17$$

23. Answer: A)

$$59.98\% \text{ of } 499.94 + 44.95\% \text{ of } 799.98 = ?$$

$$\Rightarrow 60\% \text{ of } 500 + 45\% \text{ of } 800 = ?$$

$$\Rightarrow 300 + 360 = ?$$

$$\therefore ? = 660$$

24. Answer: B)

$$(2/5 \text{ of } 224.98) \times 11.97 \div 4.98 = ?$$

$$\Rightarrow (2/5 \text{ of } 225) \times 12 \div 5 = ?$$

$$\Rightarrow 90 \times 12 \div 5 = ?$$

$$\Rightarrow 216 = ?$$

25. Answer: A)

$$(\sqrt{35.94 + 2.93})^3 = 649.97 + ?$$

$$\Rightarrow (\sqrt{36 + 3})^3 = 650 + ?$$

$$\Rightarrow (6 + 3)^3 = 650 + ?$$

$$\Rightarrow (9)^3 = 650 + ?$$

$$\Rightarrow 729 - 650 = ?$$

$$\therefore ? = 79$$

26. Answer: E)

$$(23.89 \div 6.06 \times 31.98) \div 7.94 = ?$$

$$\Rightarrow (24 \div 6 \times 32) \div 8 = ?$$

$$\Rightarrow (4 \times 32) \div 8 = ?$$

$$\Rightarrow 128 \div 8 = ?$$

$$\therefore ? = 16$$

27. Answer: C)

$$4.96^2 \times 6.93^2 = (?)^2 + 135.98$$

$$\Rightarrow 5^2 \times 7^2 = (?)^2 + 136$$

$$\Rightarrow 25 \times 49 = (?)^2 + 136$$

$$\Rightarrow 1225 = (?)^2 + 136$$

$$\Rightarrow 1225 - 136 = (?)^2$$



Ultra Practice Bundle PDF for All Bank Prelims Exams

$$\Rightarrow 1225 - 136 = (?)^2$$

$$\Rightarrow 1089 = (?)^2$$

$$\therefore ? = 33$$

28. Answer: D)

$$\sqrt[3]{511.98} \times \sqrt{35.96} - ? \times 15.98 = 31.98$$

$$\Rightarrow \sqrt[3]{512} \times \sqrt{36} - ? \times 16 = 32$$

$$\Rightarrow 8 \times 6 - ? \times 16 = 32$$

$$\Rightarrow 48 - ? \times 16 = 32$$

$$\Rightarrow 48 - 32 = ? \times 16$$

$$\Rightarrow 16 = ? \times 16$$

$$\therefore ? = 1$$

29. Answer: B)

$$53.9^2 \times 35.96 \div 2.92^3 + 7.94 = ?$$

$$\Rightarrow 54 \times 36 \div 27 + 8 = ?$$

$$\Rightarrow 1944 \div 27 + 8 = ?$$

$$\Rightarrow 72 + 8 = ?$$

$$\therefore ? = 80$$

30. Answer: E)

$$\Rightarrow \sqrt{1023.99} + \sqrt{483.94} + 399.97 \times 49.95\% = ?$$

$$\Rightarrow \sqrt{1024} + \sqrt{484} + 400 \times 50\% = ?$$

$$\Rightarrow 32 + 22 + 200 = ?$$

$$\therefore ? = 254$$

31. Answer: B)

$$29.98\% \text{ of } (24.98 \times 11.89) = ? + 39.99$$

$$\Rightarrow 30\% \text{ of } (25 \times 12) = ? + 40$$

$$\Rightarrow 30\% \text{ of } 300 = ? + 40$$

$$\Rightarrow 90 = ? + 40$$

$$\therefore ? = 50$$

32. Answer: D)

$$34.98\% \text{ of } 599.99 + 44.95\% \text{ of } 399.99 = ?$$

$$\Rightarrow 35\% \text{ of } 600 + 45\% \text{ of } 400 = ?$$

$$\Rightarrow 210 + 180 = ?$$

$$\therefore ? = 390$$

33. Answer: E)

$$\sqrt{440.91} - \sqrt{360.99} + \sqrt{624.94} = ?^3$$

$$\Rightarrow \sqrt{441} - \sqrt{361} + \sqrt{625} = ?^3$$

$$\Rightarrow 21 - 19 + 25 = ?^3$$

$$\Rightarrow 46 - 19 = ?^3$$

$$\Rightarrow 27 = ?^3$$

$$\therefore ? = 3$$

34. Answer: A)

$$\{64.98 - (55.96 - 47.98 \div 7.9 \times 5.98)\} = ?$$

$$\Rightarrow \{65 - (56 - 48 \div 8 \times 6)\} = ?$$

$$\Rightarrow \{65 - (56 - 6 \times 6)\} = ?$$

$$\Rightarrow \{65 - (56 - 36)\} = ?$$

$$\Rightarrow \{65 - 20\} = ?$$

$$\therefore ? = 45$$

35. Answer: D)

$$62.91 \div (2.93)^2 \times 3.98 - 16.97 = \sqrt{?}$$

$$\Rightarrow 63 \div (3)^2 \times 4 - 17 = \sqrt{?}$$

$$\Rightarrow 63 \div 9 \times 4 - 17 = \sqrt{?}$$

$$\Rightarrow 7 \times 4 - 17 = \sqrt{?}$$



Ultra Practice Bundle PDF for All Bank Prelims Exams

$$\Rightarrow 28 - 17 = \sqrt{?}$$

$$\Rightarrow 11 = \sqrt{?}$$

$$\therefore ? = 121$$

36. Answer: C)

$$39.98\% \text{ of } 119.67 + (2.25 \times 24.89) = ? - 39.88$$

$$40\% \text{ of } 120 + (2 \times 25) \sim ? - 40$$

$$0.40 \times 120 + 50 \sim ? - 40$$

$$? \sim 48 + 50 + 40$$

$$? \sim 138 \sim 140$$

37. Answer: A)

$$(12.69 \times 15.15) \div 4.95 + 121.21 = ?$$

$$(13 \times 15) \div 5 + 121 \sim ?$$

$$? \sim 39 + 121$$

$$? \sim 160$$

38. Answer: B)

$$(124.35 + 235.78) \div 17.89 = ? \times 4.23$$

$$(124 + 236) \div 18 \sim ? \times 4$$

$$(360 \div 18) \div 4 \sim ?$$

$$? \sim 5$$

39. Answer: B)

$$?^2 - 23.68\% \text{ of } 499.84 = \sqrt{9999} + 68.76$$

$$?^2 - 24\% \text{ of } 500 \sim \sqrt{10000} + 69$$

$$?^2 \sim 100 + 69 + 120$$

$$?^2 \sim 289$$

$$? \sim 17$$

40. Answer: A)

$$(14.78^2 + 364.89) \div 5 = ? - 122.22$$

$$(15^2 + 365) \div 5 \sim ? - 122$$

$$? \sim (118 + 122)$$

$$? \sim 240$$

41. Answer: E)

$$17.89\% \text{ of } 249.87 + 194.95 = ? \times 11.78$$

$$18\% \text{ of } 250 + 195 \sim ? \times 12$$

$$? \sim 240 \div 12$$

$$? \sim 20$$

42. Answer: D)

$$(419.78 \div 34.67) \times 4.99 = ? - 139.98$$

$$(420 \div 35) \times 5 \sim ? - 140$$

$$12 \times 5 + 140 \sim ?$$

$$? \sim 200$$

43. Answer: D)

$$24.99\% \text{ of } 799.99 + 44.99\% \text{ of } 399.99 = ?$$

$$\Rightarrow 25\% \text{ of } 800 + 45\% \text{ of } 400 = ?$$

$$\Rightarrow 200 + 180 = ?$$

$$\therefore ? = 380$$

44. Answer: E)

$$(23.98 + 35.96 \times 3.96) \div 11.98 = ?$$

$$\Rightarrow (24 + 36 \times 4) \div 12 = ?$$

$$\Rightarrow (24 + 144) \div 12 = ?$$

$$\Rightarrow 168 \div 12 = ?$$

$$\therefore ? = 14$$

45. Answer: D)



Ultra Practice Bundle PDF for All Bank Prelims Exams

$$14.94 \times 77.95 \div 12.95 - 89.99 = ?$$

$$\Rightarrow 15 \times 78 \div 13 - 90 = ?$$

$$\Rightarrow 1170 \div 13 - 90 = ?$$

$$\Rightarrow 1170 \div 13 - 90 = ?$$

$$\Rightarrow 90 - 90 = ?$$

$$\therefore ? = 0$$

46. Answer: B)

$$[(2.98^2 + 5.95^2) \times 6.98] \div 14.99 = ?$$

$$\Rightarrow [(3^2 + 6^2) \times 7] \div 15 = ?$$

$$\Rightarrow [(9 + 36) \times 7] \div 15 = ?$$

$$\Rightarrow [45 \times 7] \div 15 = ?$$

$$\Rightarrow 315 \div 15 = ?$$

$$\therefore ? = 21$$

47. Answer: E)

$$429.99 - 19.98 \times 5.98 + 3.97^3 - 12.98 = ?^2$$

$$\Rightarrow 430 - 20 \times 6 + 4^3 - 13 = ?^2$$

$$\Rightarrow 430 - 120 + 64 - 13 = ?^2$$

$$\Rightarrow 494 - 120 - 13 = ?^2$$

$$\Rightarrow 494 - 133 = ?^2$$

$$\Rightarrow 361 = ?^2$$

$$\therefore ? = 19$$

48. Answer: E)

$$487.99 - 319.99 = 317.98 - 5^2 \times ?$$

$$\Rightarrow 488 - 320 = 318 - 25 \times ?$$

$$\Rightarrow 168 = 318 - 25 \times ?$$

$$\Rightarrow 25 \times ? = 150$$

$$\Rightarrow ? = 150/25$$

$$\Rightarrow ? \approx 6$$

49. Answer: A)

$$79.99\% \text{ of } 599.99 \div 11.92 - 39.99 + \sqrt{483.94} = ?$$

$$\Rightarrow 80\% \text{ of } 600 \div 12 - 40 + \sqrt{484} = ?$$

$$\Rightarrow 480 \div 12 - 40 + 22 = ?$$

$$\Rightarrow 40 - 40 + 22 = ?$$

$$\therefore ? = 22$$

50. Answer: C)

$$563.94 \div 5.96 + 25.99 = 239.99 \div ?$$

$$\Rightarrow 564 \div 6 + 26 = 240 \div ?$$

$$\Rightarrow 94 + 26 = 240 \div ?$$

$$\Rightarrow 120 = 240 \div ?$$

$$\Rightarrow ? = 240/120$$

$$\Rightarrow ? \approx 2$$

2.Simplification

Directions (1-50): What value should come in the place of question mark (?) in the following questions?

1. $18/34 + 78/34 + 480/5 + 74/34 = ?$

a) 108

b) 107



Ultra Practice Bundle PDF for All Bank Prelims Exams

- c) 121
d) 101
e) 116
2. $6/15$ of $264/792$ of? = 158
a) 1780
b) 1560
c) 1540
d) 1120
e) 1185
3. $\sqrt[3]{10648} * \sqrt[3]{5832} * \sqrt[3]{13824} = ?$
a) 9504
b) 1004
c) 9804
d) 8504
e) 7504
4. 50% of 25% of $4/5$ of? = 640
a) 6540
b) 6600
c) 6400
d) 5220
e) 4280
5. $440 + 4444 - 44444 + 44 - 40 + 44044 = ?$
a) 4848
b) 4488
c) 5488
d) 3418
e) 5788
6. $(158+97) \times (11 + 1.2 + 2.8) \times (12) = ?$
a) 56100
b) 47500
c) 45900
d) 76100
e) 63400
7. $4/5$ of 48% of 700 – 15.4 =?
a) None
b) 152.4
c) 453.4
d) 253.4
e) 615.3
8. $125 - 4^3 + 52^2 = ?$
a) 2694
b) 2465
c) 2765
d) 1786
e) 1456
9. 15% of $28\frac{4}{7}\%$ of ? = 240
a) 5800
b) 6300
c) 6100
d) 5600
e) 5300
10. $1674 \div 27 \times 9 + 18 = ?^2$



Ultra Practice Bundle PDF for All Bank Prelims Exams

a) 26

b) 23

c) 24

d) 35

e) 18

11. 320% of $700 - 70\%$ of $320 - 3.2\%$ of $7000 = ?$

a) 1792

b) 224

c) -1792

d) -224

e) 1972

12. $(7294 - 3241 + 716) - (3267 + 2425 - 961) = ?$

a) 35

b) 36

c) 37

d) 38

e) 43

13. $32/35 \div 1/5 \times 7/8 \div 2/35 = ?$

a) 60

b) 80

c) 50

d) 90

e) 70

14. $\sqrt{?} + \sqrt{324} + \sqrt{361} = \frac{1}{5}\text{th of } 290$

a) 400

b) 441

c) 361

d) 484

e) 289

15. $\sqrt{3025} - \sqrt{2116} = ?^2$

a) 81

b) 9

c) 3

d) 27

e) 729

16. $\frac{5}{8}\text{th of } \frac{9}{5}\text{th of } \frac{4}{7}\text{th of } ? = 2610$

a) 4060

b) 4660

c) 6040

d) 4260

e) 4160

17. $8\frac{1}{4} - 12\frac{2}{3} + 11\frac{3}{5} = ? + 7\frac{3}{20}$

a) $1/50$

b) $1/25$

c) $1/30$

d) $1/40$

e) $1/60$

18. $\frac{16}{?} + \frac{48}{2?} = \sqrt{400}$

a) 4

b) 1



Ultra Practice Bundle PDF for All Bank Prelims Exams

c) 3

d) 2

e) 5

19. $38^2 - 37^2 + 6 = ?^2$

a) 0.8

b) 9

c) 0.9

d) 1

e) 8

20. $900^{\frac{1}{2}} + \sqrt[3]{1000} = \sqrt[3]{5832} + ?$

a) 27

b) 25

c) 22

d) 17

e) 12

21. $24\% \text{ of } 400 + \sqrt{1296} = 34 + ?$

a) 104

b) 96

c) 198

d) 98

e) 100

22. $\frac{16^2 - 68}{4} = 180 - ?$

a) 133

b) 152

c) 263

d) 126

e) 283

23. $\frac{5}{8} + \frac{1}{2} + \frac{3}{4} = ?$

a) $13/4$

b) $15/8$

c) $3/4$

d) $13/9$

e) $12/7$

24. $45 \times 3/5 + ? \div 2 = 105$

a) 172

b) 127

c) 156

d) 165

e) 128

25. $4586 + 4210 = 3598 - 1258 + ?$

a) 6456

b) 7456

c) 5456

d) 4440

e) 5420

26. $28\% \text{ of } 500 - 120 = ? \div 3$

a) 32

b) 60

c) 54



Ultra Practice Bundle PDF for All Bank Prelims Exams

d) 48

e) 64

27. $(12^2 \times 5) \div 16 + 155 = ?$

a) 400

b) 350

c) 540

d) 200

e) 250

28. $(3/8) \times \{(512 - 128)\} = ? \times 12$

a) 10

b) 18

c) 12

d) 14

e) 16

29. $(18^3 \times 5) \div 18^2 = ? - (27 \times 5)$

a) 295

b) 320

c) 270

d) 225

e) 215

30. $\{(450 \div 5) + 110\} \div 5 = ? \div 3$

a) 100

b) 250

c) 120

d) 160

e) 300

31. $(360 - 15^2) \times 6 - 210 = ? \times 12$

a) 100

b) 50

c) 80

d) 20

e) 40

32. $(45 \times 8) - 16\% \text{ of } 2000 = ? - 260$

a) 100

b) 250

c) 400

d) 450

e) 300

33. $24\% \text{ of } 500 + 30^2 = ? \times 51$

a) 35

b) 20

c) 15

d) 25

e) 30

34. $(3/8) \times 560 + (2/5) \times 350 - (3/4) \times 200 = ?$

a) 100

b) 180

c) 150

d) 240

e) 200

35. $50\% \text{ of } 1200 - 320 = ? + 12\% \text{ of } 1500$

a) 100

Ultra Practice Bundle PDF for All Bank Prelims Exams

- b) 120
c) 150
d) 80
e) 140
36. $\sqrt{484} + ? = 4\frac{5}{6}$ of 102
- a) 453
b) 463
c) 471
d) 477
e) 501
37. $27 \times 27 - 9 = ? \times 40$
- a) 30
b) 0
c) -2
d) 18
e) 1
38. $19^2 - 30^2 + 21^2 = ?$
- a) -108
b) -68
c) -98
d) -168
e) -88
39. $8 \times 46 - 30 \times 22 = ?$
- a) -314
b) -277
c) -288
d) -294
e) -292
40. 80% of 370 + 10% of 510 = ?
- a) 347
b) 447
c) 267
d) 377
e) 367
41. $[(185)^2 \div 25 \times 15] = ?$
- a) 25035
b) 25305
c) 20535
d) 24035
e) 26035
42. 45% of 52% of 600 = ?
- a) 144.20
b) 145.10
c) 111.10
d) 140.40
e) 101.20
43. $3\frac{1}{3} + 1\frac{1}{5} + 2\frac{1}{4} + 1\frac{1}{7} = ?$
- a) $7\frac{389}{420}$
b) $7\frac{289}{420}$
c) $7\frac{298}{420}$
d) $7\frac{189}{320}$



Ultra Practice Bundle PDF for All Bank Prelims Exams

e) $7\frac{489}{520}$

44. $1\frac{1}{3} \div 1\frac{7}{9} \times 1\frac{5}{7} \div 7\frac{1}{2} = ?$

a) $6/35$

b) $8/105$

c) $21/205$

d) $31/305$

e) $8/205$

45. $75157 - ? - 331 - 30 + 530 = 69874$

a) 5452

b) 6252

c) 4425

d) 4525

e) 4441

46. $0.06 \times 0.84 = ? \times 1.2 \times 0.015$

a) 8.2

b) 6.4

c) 2.6

d) 3.8

e) 2.8

47. $8.41 + 6.25 + 0.79 = ? - 0.55$

a) 17

b) 14.9

c) 13.9

d) 16

e) 14.7

48. $\frac{(12+44)}{8} \times 28 = ?^2$

a) 13

b) 16

c) 17

d) 14

e) 19

49. $616 + 472 - 811 + 317 = ? + 576$

a) 28

b) 16

c) 24

d) 18

e) 14

50. $12.5 \times 80 + 37.5 \times 16 - 6.25 \times 112 = ?$

a) 1000

b) 900

c) 2300

d) 600

e) 1300

Solutions with Explanation



Ultra Practice Bundle PDF for All Bank Prelims Exams

1. Answer: D)

$$(18+78+74)/34+480/5 = ?$$

$$5+96 = ?$$

$$101 = ?$$

2. Answer: E)

$$6/15 \text{ of } 264/792 \text{ of } ? = 158$$

$$? = 158 * 15 * 792 / (6 * 264)$$

$$? = 1185$$

3. Answer: A)

$$22 \times 18 \times 24 = 9504$$

4. Answer: C)

$$50\% \text{ of } 25\% \text{ of } 4/5 \text{ of } ? = 640$$

$$640 * 2 * 4 * 5 / (4) = ?$$

$$6400 = ?$$

5. Answer: B)

$$440+4444+44+44044 - 44444-40 = ?$$

$$48972 - 44484 = ?$$

$$4488 = ?$$

6. Answer: C)

$$255 \times 15 \times 12 = ?$$

$$? = 45900$$

7. Answer: D)

$$0.8 \times 48 \times 7 - 15.4 = ?$$

$$268.8 - 15.4 = ?$$

$$? = 253.4$$

8. Answer: C)

$$125 - 4^3 + 52^2 = ?$$

$$125 - 64 + 2704 = ?$$

$$2765 = ?$$

9. Answer: D)

$$\frac{15}{100} \times \frac{200}{700} \times ? = 240$$

$$? = 240 \times \frac{7}{2} \times \frac{20}{3}$$

$$? = 5600$$

10. Answer: C)

$$1674 \times \frac{1}{27} \times 9 + 18 = ?^2$$

$$62 \times 9 + 18 = ?^2$$

$$?^2 = 576$$

$$? = 24$$

11. Answer: A)

$$\frac{320}{100} \times 700 - \frac{70}{100} \times 320 - \frac{3.2}{100} \times 7000 = ?$$

$$2240 - 224 - 224 = ?$$

$$? = 1792$$

12. Answer: D)

$$4769 - 4731 = ?$$

$$? = 38$$

13. Answer: E)

$$\frac{32}{35} \times 5 \times \frac{7}{8} \times \frac{35}{2} = ?$$

$$? = 70$$

14. Answer: B)

$$\sqrt{?} + 18 + 19 = \frac{290}{5}$$

$$\sqrt{?} = 58 - 37$$

$$\sqrt{?} = 21$$

$$? = 441$$

15. Answer: C)



Ultra Practice Bundle PDF for All Bank Prelims Exams

$$55 - 46 = ?^2$$

$$?^2 = 9$$

$$? = 3$$

16. Answer: A)

$$\frac{5}{8} \times \frac{9}{5} \times \frac{4}{7} \times ? = 2610$$

$$? = 2610 \times \frac{14}{9}$$

$$? = 4060$$

17. Answer: C)

$$\frac{33}{4} - \frac{38}{3} + \frac{58}{5} = ? + \frac{143}{20}$$

$$? = \frac{431}{60} - \frac{143}{20}$$

$$? = \frac{431 - 429}{60} = \frac{1}{30}$$

18. Answer: D)

$$\frac{16}{?} + \frac{24}{?} = 20$$

$$\frac{40}{?} = 20$$

$$? = 2$$

19. Answer: B)

$$38^2 - 37^2 + 6 = ?^2$$

$$\Rightarrow 1444 - 1369 + 6 = ?^2$$

$$\Rightarrow \sqrt{81}$$

$$\Rightarrow 9$$

20. Answer: C)

$$900^{\frac{1}{2}} + \sqrt[3]{1000} = \sqrt[3]{5832} + ?$$

$$\Rightarrow 30 + 10 = 18 + ?$$

$$\Rightarrow 22 = ?$$

21. Answer: D)

$$24\% \text{ of } 400 + \sqrt{1296} = 34 + ?$$

$$\Rightarrow 96 + 36 - 34$$

$$\Rightarrow 98$$

22. Answer: A)

$$\frac{16^2 - 68}{4} = 180 - ?$$

$$\frac{256 - 68}{4} = 180 - ?$$

$$\frac{188}{4} = 180 - ?$$

$$? = 180 - 47 = 133$$

23. Answer: B)

$$5/8 + 1/2 + 3/4 = (5 + 4 + 6)/8 = 15/8$$

24. Answer: C)

$$45 \times 3/5 + ? \div 2 = 105$$

$$27 + ?/2 = 105$$

$$?/2 = 78$$

$$? = 156$$

25. Answer: A)

$$\Rightarrow 4586 + 4210 = 3598 - 1258 + ?$$

$$\Rightarrow 6456$$

26. Answer: B)

$$28\% \text{ of } 500 - 120 = ? \div 3$$

$$0.28 \times 500 - 120 = ? \div 3$$

$$? = 20 \times 3 = 60$$

27. Answer: D)



Ultra Practice Bundle PDF for All Bank Prelims Exams

$$(12^2 \times 5) \div 16 + 155 = ?$$

$$(144 \times 5) \div 16 + 155 = ?$$

$$? = 200$$

28. Answer: C)

$$(3/8) \times \{(512 - 128)\} = ? \times 12$$

$$(3/8) \times 384 = ? \times 12$$

$$? = 144 \div 12$$

$$? = 12$$

29. Answer: D)

$$(18^3 \times 5) \div 18^2 = ? - (27 \times 5)$$

$$? = (18 \times 5) + 135$$

$$? = 225$$

30. Answer: C)

$$\{(450 \div 5) + 110\} \div 5 = ? \div 3$$

$$(90 + 110) \div 5 = ? \div 3$$

$$? = 40 \times 3$$

$$? = 120$$

31. Answer: B)

$$(360 - 15^2) \times 6 - 210 = ? \times 12$$

$$(360 - 225) \times 6 - 210 = ? \times 12$$

$$? = 600 \div 12$$

$$? = 50$$

32. Answer: E)

$$(45 \times 8) - 16\% \text{ of } 2000 = ? - 260$$

$$360 - 0.16 \times 2000 = ? - 260$$

$$? = 360 - 320 + 260$$

$$? = 300$$

33. Answer: B)

$$24\% \text{ of } 500 + 30^2 = ? \times 51$$

$$0.24 \times 500 + 900 = ? \times 51$$

$$? = (120 + 900) \div 51 = 20$$

34. Answer: E)

$$(3/8) \times 560 + (2/5) \times 350 - (3/4) \times 200 = ?$$

$$(3 \times 70) + (2 \times 70) - (3 \times 50) = ?$$

$$? = 210 + 140 - 150$$

$$? = 200$$

35. Answer: A)

$$50\% \text{ of } 1200 - 320 = ? + 12\% \text{ of } 1500$$

$$0.50 \times 1200 - 320 = ? + 0.12 \times 1500$$

$$? = 600 - 320 - 180$$

$$? = 100$$

36. Answer: C)

$$? = 102 \times (29/6) - \sqrt{484}$$

$$= 17 \times 29 - 22$$

$$= 493 - 22 = 471$$

37. Answer: D)

$$? = (27 \times 27 - 9)/40$$

$$= (729 - 9)/40$$

$$= 720/40 = 18$$

38. Answer: C)

$$? = 19^2 - 30^2 + 21^2$$

$$= 361 - 900 + 441 = -98$$



Ultra Practice Bundle PDF for All Bank Prelims Exams

39. Answer: E)

$$? = 8 \times 46 - 30 \times 22$$

$$= 368 - 660$$

$$= -292$$

40. Answer: A)

$$? = (80 \times 370/100) + (10 \times 510/100)$$

$$= (29600/100) + (5100/100)$$

$$= 296 + 51 = 347$$

41. Answer: C)

$$[1369 \times 15] = ?$$

$$20535 = ?$$

42. Answer: D)

$$45\% \text{ of } 52\% \text{ of } 600 = ?$$

$$45/100 \times 52/100 \times 600 = ?$$

$$140.40 = ?$$

43. Answer: A)

$$3+1+2+1(1/3+1/5+1/4+1/7) = ?$$

$$7(389/420) = ?$$

44. Answer: A)

$$4/3 \times 9/16 \times 12/7 \times 2/15 = ?$$

$$? = 6/35$$

45. Answer: A)

$$75687 - 70235 = ?$$

$$? = 5452$$

46. Answer: E)

$$? = \frac{0.06 \times 0.84}{1.2 \times 0.015}$$

$$? = 2.8$$

47. Answer: D)

$$? = 15.45 + 0.55$$

$$? = 16$$

48. Answer: D)

$$?^2 = \frac{56}{8} \times 28$$

$$?^2 = 196$$

$$? = 14$$

49. Answer: D)

$$? = 1405 - 811 - 576$$

$$? = 18$$

50. Answer: B)

$$\frac{100}{8} \times 80 + \frac{300}{8} \times 16 - \frac{100}{16} \times 112 = ?$$

$$? = 1000 + 600 - 700$$

$$? = 900$$

3. Missing Number series

Direction (1-50): What value should come in the place of (?) in the following number series?

1. 10, 12, 15, 19, ?, 30



Ultra Practice Bundle PDF for All Bank Prelims Exams

A.24

B.26

C.37

D.28

E.25

2. 5, 12, 39, ?, 805

A.230

B.360

C.150

D.160

E.785

3. 11, 31, 21, 41, 31, ?

A.61

B.71

C.81

D.91

E.51

4. 5, 5, 10, ? , 320, 5120

A.50

B.60

C.40

D.30

E.51

5. 10, 5, 14, ?, 18, -3

A.2

B.4

C.1

D.8

E.-

6. 15, 16, 24, 51, 115, ?

A.186

B.198

C.214

D.240

E.245

7. 12, 18, 36, 90, ?, 945

A.280

B.240

C.250

D.260



Ultra Practice Bundle PDF for All Bank Prelims Exams

- | | |
|--------------------------------|-------------------------------|
| E.270 | A.1207 |
| 8. 4913, 2197, ?, 343, 125, 27 | B.1287 |
| A.1197 | C.1276 |
| B.1331 | D.1285 |
| C.216 | E.1294 |
| D.1728 | 12. 4, 32, 77, 141, 226, ? |
| E.512 | A.332 |
| 9. 35, 46, 59, 76, 99, ? | B.341 |
| A.130 | C.334 |
| B.136 | D.338 |
| C.142 | E.330 |
| D.145 | 13. 7, 20, 37, 56, 79, ? |
| E.148 | A.111 |
| 10. 19, 38, 67, 106, 155, ? | B.108 |
| A.208 | C.118 |
| B.210 | D.105 |
| C.214 | E.115 |
| D.220 | 14. 26, 54, 181, 527, ?, 2596 |
| E.228 | A.1080 |
| 11. 8, 9, 20, 63, 256, ? | B.1120 |



Ultra Practice Bundle PDF for All Bank Prelims Exams

C.1180

D.1260

E.1220

15. 6, 30, 66, 114, 174, ?

A.246

B.248

C.251

D.258

E.261

16. 18, 55, 167, 504, ?, 4553

A.1532

B.1516

C.1782

D.1592

E.2018

17. 960, 1023, 1088, 1155, 1224, ?

A.1290

B.1285

C.1295

D.1225

E.1320

18. 32, 49, 75, 112, 162, ?

A.184

B.217

C.227

D.235

E.248

19. 19, 19, 21, 27, 39, ?

A.41

B.56

C.48

D.59

E.45

20. 10, 16, 28, ?, 78, 120

A.36

B.40

C.44

D.48

E.52

21. 781, 556, 387, 266, 185, ?



Ultra Practice Bundle PDF for All Bank Prelims Exams

A.136

B.98

C.167

D.197

E.150

22. 1716, 2183, 2728, 3357, 4076, ?

A.4129

B.4586

C.4762

D.4871

E.4891

23. 7, 45, 96, 148, 203, ?

A.243

B.245

C.251

D.258

E.261

24. 5, 28, 47, 64, 77, ?

A.96

B.98

C.85

D.106

E.88

25. 6, 4, 5, 11, 39, ?

A.160

B.193

C.189

D.183

E.171

26. 29, 15, 16, 34, 140, ?

A.335

B.448

C.1128

D.347

E.455

27. 89, 88, 85, 78, 63, ?

A.32

B.30

C.34

D.27

Ultra Practice Bundle PDF for All Bank Prelims Exams

E.23

28. 190, 94, 46, 22, ?, 4

A.16

B.10

C.9

D.13

E.8

29. 1, 4, 20, 120,?, 6720

A.840

B.856

C.720

D.732

E.680

30. 62, 122, 212, 338, 506, ?

A.722

B.738

C.714

D.706

E.762

31. 20, 28, 37, 101, 126, ?

A.325

B.342

C.337

D.320

E.328

32. 23, 33, 63, 113, ?, 273

A.163

B.143

C.183

D.193

E.153

33. 1944, 968, 480, 236, 114, ?

A.53

B.60

C.65

D.70

E.49

34. 35, 49, 63, 77, 91, ?

A.100

B.102



Ultra Practice Bundle PDF for All Bank Prelims Exams

C.103	E.1233
D.105	38. 12, 54, 124, 222, 348, ?
E.115	A.498
35. 88, 165, 220, 253, ?	B.486
A.261	C.502
B.258	D.512
C.264	E.490
D.268	39. 678, 637, 594, 547, 494, ?
E.270	A.423
36. 85, 110, 94, 103, 99, ?	B.432
A.20	C.435
B.60	D.428
C.80	E.439
D.100	40. 24, 45, 80, 129, ?, 297
E.110	A.184
37. ?, 1235, 1252, 1295, 1384	B.196
A.1235	C.190
B.1230	D.206
C.1225	E.212
D.1220	41. 23, 138, 690, ?, 8280, 16560



Ultra Practice Bundle PDF for All Bank Prelims Exams

A.1840

B.2240

C.2760

D.3230

E.3890

42. 18, 19, 39, 118, 473, ?

A.946

B.1319

C.2366

D.1893

E.2839

43. 13, 36, 65, 96, 133, ?

A.156

B.168

C.148

D.174

E.181

44. 17, 21, ?, 46, 71, 107

A.15

B.30

C.25

D.20

E.35

45. 3, 15, 35, 63, ?

A.79

B.89

C.99

D.68

E.72

46. 1, 9, 21, ?, 63, 93

A.39

B.42

C.37

D.41

E. None of these

47. 1, $5/2$, 5, ?, 13, $37/2$, 25

A. $21/2$

B. $19/2$

C. $17/2$

D. $23/2$

Ultra Practice Bundle PDF for All Bank Prelims Exams

E. None of these

48. 1290, 645, 430,?, 258, 215

A.317.5

B.322.5

C.215

D.332.5

E.324.25

49. 1260, 210, 42, 10.5, 3.5,?

A.1.75

B.1.25

C.2.25

D.1.60

E.2.75

50. 28, 41, 56, 73, 92, ?

A.120

B.113

C.131

D.135

E.130

Solutions with Explanation:

1. Answer: A

$$10 + 2 = 12$$

$$12 + 3 = 15$$

$$15 + 4 = 19$$

$$19 + 5 = 24$$

$$24 + 6 = 30$$

2. Answer: D

$$5 * 2 + 2 = 12$$

$$12 * 3 + 3 = 39$$

$$39 * 4 + 4 = 160$$

$$160 * 5 + 5 = 805$$

3. Answer: E

$$11 + 20 = 31$$

$$31 - 10 = 21$$

$$21 + 20 = 41$$

$$41 - 10 = 31$$

Ultra Practice Bundle PDF for All Bank Prelims Exams

$31 + 20 = 51$

4. Answer: C

$5 * 1 = 5$

$5 * 2 = 10$

$10 * 4 = 40$

$40 * 8 = 320$

$320 * 16 = 5120$

5. Answer: C

Alternate number's series:

$10 + 4 = 14$

$14 + 4 = 18$

And

$5 - 4 = 1$

$1 - 4 = -3$

6. Answer: D

$15 + 1^3 = 16$

$16 + 2^3 = 24$

$24 + 3^3 = 51$

$51 + 4^3 = 115$

$115 + 5^3 = 240$

7. Answer: E

$12 * 1.5 = 18$

$18 * 2 = 36$

$36 * 2.5 = 90$

$90 * 3 = 270$

$270 * 3.5 = 945$

8. Answer: B

Cube of prime numbers

$17^3 = 4913$

$13^3 = 2197$

$11^3 = 1331$

$7^3 = 343$

$5^3 = 125$

$3^3 = 27$

9. Answer: A

$35 \quad 46 \quad 59 \quad 76 \quad 99 \quad 130$

$11 \quad 13 \quad 17 \quad 23 \quad 31$

$2 \quad 4 \quad 6 \quad 8$

10. Answer: C



Ultra Practice Bundle PDF for All Bank Prelims Exams

$19 + 19 = 38$

$38 + 29 = 67$

$67 + 39 = 106$

$106 + 49 = 155$

$155 + 59 = 214$

11. Answer: D

$8 * 1 + 1 = 9$

$9 * 2 + 2 = 20$

$20 * 3 + 3 = 63$

$63 * 4 + 4 = 256$

$256 * 5 + 5 = 1285$

12. Answer: C

$4 + (2 * 14) = 32$

$32 + (3 * 15) = 77$

$77 + (4 * 16) = 141$

$141 + (5 * 17) = 226$

$226 + (6 * 18) = 334$

13. Answer: B

$7 + 13 = 20$

$20 + 17 = 37$

$37 + 19 = 56$

$56 + 23 = 79$

$79 + 29 = 108$

14. Answer: D

$26 + 3^3 + 1 = 54$

$54 + 5^3 + 2 = 181$

$181 + 7^3 + 3 = 527$

$527 + 9^3 + 4 = 1260$

$1260 + 11^3 + 5 = 2596$

15. Answer: A

$6 + (12 * 2) = 30$

$30 + (12 * 3) = 66$

$66 + (12 * 4) = 114$

$114 + (12 * 5) = 174$

$174 + (12 * 6) = 246$

16. Answer: B

$18 * 3 + 1 = 55$

$55 * 3 + 2 = 167$

$167 * 3 + 3 = 504$

$504 * 3 + 4 = 1516$



Ultra Practice Bundle PDF for All Bank Prelims Exams

$$1516 * 3 + 5 = 4553$$

17. Answer: C

$$31^2 - 1 = 960$$

$$32^2 - 1 = 1023$$

$$33^2 - 1 = 1088$$

$$34^2 - 1 = 1155$$

$$35^2 - 1 = 1224$$

$$36^2 - 1 = 1295$$

18. Answer: C

$$32 + 4^2 + 1 = 49$$

$$49 + 5^2 + 1 = 75$$

$$75 + 6^2 + 1 = 112$$

$$112 + 7^2 + 1 = 162$$

$$162 + 8^2 + 1 = 227$$

19. Answer: D

$$19 + 1^2 - 1 = 19$$

$$19 + 2^2 - 2 = 21$$

$$21 + 3^2 - 3 = 27$$

$$27 + 4^2 - 4 = 39$$

$$39 + 5^2 - 5 = 59$$

20. Answer: D

$$10 + (2 * 3) = 16$$

$$16 + (3 * 4) = 28$$

$$28 + (4 * 5) = \mathbf{48}$$

$$48 + (5 * 6) = 78$$

$$78 + (6 * 7) = 120$$

21. Answer: A

$$781 - 15^2 = 556$$

$$556 - 13^2 = 387$$

$$387 - 11^2 = 266$$

$$266 - 9^2 = 185$$

$$185 - 7^2 = \mathbf{136}$$

22. Answer: E

$$12^3 - 12 = 1716$$

$$13^3 - 14 = 2183$$

$$14^3 - 16 = 2728$$

$$15^3 - 18 = 3357$$

$$16^3 - 20 = 4076$$

$$17^3 - 22 = \mathbf{4891}$$

23. Answer: B



Ultra Practice Bundle PDF for All Bank Prelims Exams

$7 + (19 * 2) = 45$

$45 + (17 * 3) = 96$

$96 + (13 * 4) = 148$

$148 + (11 * 5) = 203$

$203 + (7 * 6) = \mathbf{245}$

24. Answer: E

The pattern is, +23, +19, +17, +13, +11

The answer is, 88

25. Answer: C

The pattern is, *1-2, *2-3, *3-4, *4-5, *5-6

The answer is, 189

26. Answer: C

The pattern is, *0.5 + 0.5, *1 + 1, *2, +2, *4 + 4, *8 + 8

The answer is, 1128

27. Answer: A

89,	88,	85,	78,	63,	32
1	3	7	15	31	
	2	4	8	16	

The answer is, **32**

28. Answer: B

$190 - 2 = 188/2 = 94$

$94 - 2 = 92, 92/2 = 46$

$46 - 2 = 44, 44/2 = 22$

$22 - 2 = 20, 20/2 = 10$

29. Answer: A

$1 * 4 = 4$

$4 * 5 = 20$

$20 * 6 = 120$

$120 * 7 = \mathbf{840}$

$840 * 8 = 6720$

30. Answer: A

$4^3 - 2 = 62$

$5^3 - 3 = 122$

$6^3 - 4 = 212$

$7^3 - 5 = 338$

$8^3 - 6 = 506$

$9^3 - 7 = \mathbf{722}$

31. Answer: B

$20 + 2^3 = 28$

$28 + 3^2 = 37$

$37 + 4^3 = 101$

$101 + 5^2 = 126$



Ultra Practice Bundle PDF for All Bank Prelims Exams

$126 + 6^3 = 342$

32. Answer: C

$23 + 10 = 33$

$33 + 30 = 63$

$63 + 50 = 113$

$113 + 70 = 183$

$183 + 90 = 273$

33. Answer: A

$1944/2 - 4 = 968$

$968/2 - 4 = 480$

$480/2 - 4 = 236$

$236/2 - 4 = 114$

$114/2 - 4 = 53$

34. Answer: D

35	49	63	77	91	105
	14	14	14	14	14

35. Answer: C

$88 + 77 = 165$

$165 + 55 = 220$

$220 + 33 = 253$

$253 + 11 = 264$

36. Answer: D

$85 + 5^2 = 110$

$110 - 4^2 = 94$

$94 + 3^2 = 103$

$103 - 2^2 = 99$

$99 + 1^2 = 100$

37. Answer: B

1230	1235	1252	1295	1384
	5	17	43	89
	$(1^3 + 2^2)$	$(2^3 + 3^2)$	$(3^3 + 4^2)$	$(4^3 + 5^2)$

38. Answer: C

$12 + (14 * 3) = 54$

$54 + (14 * 5) = 124$

$124 + (14 * 7) = 222$

$222 + (14 * 9) = 348$

$348 + (14 * 11) = 502$

39. Answer: C



Ultra Practice Bundle PDF for All Bank Prelims Exams

$$678 - 41 = 637$$

$$637 - 43 = 594$$

$$594 - 47 = 547$$

$$547 - 53 = 494$$

$$494 - 59 = \mathbf{435}$$

40. Answer: D

$$24 + (3 * 7) = 45$$

$$45 + (5 * 7) = 80$$

$$80 + (7 * 7) = 129$$

$$129 + (11 * 7) = \mathbf{206}$$

$$206 + (13 * 7) = 297$$

41. Answer: C

$$23 * 6 = 138$$

$$138 * 5 = 690$$

$$690 * 4 = \mathbf{2760}$$

$$2760 * 3 = 8280$$

$$8280 * 2 = 16560$$

42. Answer: C

$$18 * 1 + 1 = 19$$

$$19 * 2 + 1 = 39$$

$$39 * 3 + 1 = 118$$

$$118 * 4 + 1 = 473$$

$$473 * 5 + 1 = 2366$$

43. Answer: D

13 + 23 = 36 (addition of prime numbers from 23 and so on)

$$36 + 29 = 65$$

$$65 + 31 = 96$$

$$96 + 37 = 133$$

$$133 + 41 = 174$$

44. Answer: B

17	21	30	46	71	107
	4 (2 ²)	9 (3 ²)	16 (4 ²)	25 (5 ²)	36 (6 ²)

45. Answer: C

$$2^2 - 1 = 3$$

$$4^2 - 1 = 15$$

$$6^2 - 1 = 35$$

$$8^2 - 1 = 63$$

$$10^2 - 1 = \mathbf{99}$$



Ultra Practice Bundle PDF for All Bank Prelims Exams

46. Answer: A

1	9	21	39	63	93
8	12	18	24	30	

Here, $3 + 5 = 8$ (sum of prime numbers)

$$5 + 7 = 12$$

$$7 + 11 = 18$$

$$11 + 13 = 24$$

$$13 + 17 = 30$$

Therefore, $21 + 18 = 39$

47. Answer: C

$$1 + 3/2 = 5/2$$

$$5/2 + 5/2 = 5$$

$$5 + 7/2 = 17/2$$

$$17/2 + 9/2 = 13$$

$$13 + 11/2 = 37/2$$

$$37/2 + 13/2 = 25$$

48. Answer: B

$$1290 \times 1/2 = 645$$

$$645 \times 2/3 = 430$$

$$430 \times 3/4 = 322.5$$

$$322.5 \times 4/5 = 258$$

$$258 \times 5/6 = 215$$

49. Answer: A

$$1260 \div 6 = 210$$

$$210 \div 5 = 42$$

$$42 \div 4 = 10.5$$

$$10.5 \div 3 = 3.5$$

$$3.5 \div 2 = 1.75$$

50. Answer: B

$$9 * 3 + 1 = 28$$

$$10 * 4 + 1 = 41$$

$$11 * 5 + 1 = 56$$

$$12 * 6 + 1 = 73$$

$$13 * 7 + 1 = 92$$

$$14 * 8 + 1 = 113$$

Wrong Number series

Direction (1-50). Find out the wrong number in the following number series.

1. 2.5, 5, 25, 200, 2201, 30800

A.2.5

B.200

C.2201

D.25

E.5

2. 70, 68, 135, 395, 1575, 7869

A.1575

B.68

C.135

D.70

E.5395

3. 643, 768, 805, 1147, 1211, 1940

A.805

B.643

C.768

D.1211

E.1940

4. 8, 5, 6, 11, 21, 53.5

A.53.5

B.11

C.21

D.5

E.6

5. 339, 341, 345, 353, 369, 400

A.400

B.341

C.345

D.353

E.339

6. 5, 20, 50, 112, 230, 470

A.112

B.20

C.50



Ultra Practice Bundle PDF for All Bank Prelims Exams

D.230	10. 0.5, 2, 4, 7.5, 9.5, 13
E.470	A.3
7. 20, 25, 21, 27, 24, 29	B.14
A.20	C.10.5
B.21	D.5
C.27	E.7.5
D.24	11. 513, 520, 530, 544, 561, 580
E.29	A.513
8. 3,4,10,17,33,58	B.530
A.58	C.520
B.4	D.544
C.10	E.561
D.17	12. 305, 336, 373, 422, 494, 616
E.33	A.305
9. 2, 22, 47, 77, 115	B.422
A.115	C.373
B.77	D.494
C.47	E.616
D.22	13. 15, 14, 25, 75, 296, 1475
E.2	A.14



Ultra Practice Bundle PDF for All Bank Prelims Exams

B.1475

C.25

D.296

E.15

14. 4, 13, 41, 125, 389, 1183

A.13

B.389

C.41

D.1183

E.125

15. 105, 116, 131, 149, 167, 190

A.131

B.190

C.149

D.167

E.105

16. 32, 52, 92, 172, 332, 650

A.332

B.92

C.650

D.172

E.33

17. 256, 240, 218, 179, 130, 66

A.218

B.66

C.179

D.240

E.130

18. 32, 39, 56, 63, 80, 99

A.39

B.56

C.99

D.80

E.63

19. 24, 47, 78, 117, 164, 220

A.164

B.78

C.220

D.117

E.47

Ultra Practice Bundle PDF for All Bank Prelims Exams

20. 13, 26, 78, 312, 1560, 9380

A.13

B.26

C.312

D.9380

E.1560

21. 8, 19, 35, 56, 82, 111

A.111

B.56

C.19

D.82

E.35

22. 67, 132, 183, 222, 251, 275

A.251

B.222

C.275

D.183

E.132

23. 19, 21, 33, 73, 188, 473

A.21

B.188

C.33

D.473

E.73

24. 13, 23, 41, 65, 101, 143

A.65

B.101

C.23

D.143

E.41

25. 1.2, 12, 108, 972, 6048, 36288

A.6048

B.12

C.108

D.972

E.36288

26. 96, 420, 131, 385, 162, 358

A.385

B.162

C.420

Ultra Practice Bundle PDF for All Bank Prelims Exams

D.358	30. 343, 279, 247, 231, 223, 214
E.131	A.214
27. 1, 6, 21, 46, 80, 126	B.231
A.46	C.247
B.126	D.279
C.80	E.223
D.21	31. 0, 6, 22, 60, 120
E.6	A.6
28. 145, 200, 265, 340, 425, 530	B.22
A.340	C.60
B.265	D.120
C.530	E.0
D.425	32. 512, 24, 343, 25, 216
E.200	A.24
29. 13, 14, 29, 88, 353, 1768	B.343
A.88	C.25
B.353	D.216
C.14	E.512
D.29	33. 12, 20, 30, 44, 56
E.1768	A.12



Ultra Practice Bundle PDF for All Bank Prelims Exams

B.20

C.30

D.44

E.56

34. 10, 24, 68, 100, 222

A.10

B.24

C.68

D.100

E.222

35. 3, 7, 13, 20, 31

A.3

B.7

C.13

D.20

E.21

36. 4, 6, 15, 31, 56, 92

A.4

B.15

C.6

D.46

E.21

37. 7, 14, 23, 36, 55, 94, 163

A.7

B.25

C.14

D.55

E.94

38. 36, 72, 180, 540, 1890, 7650

A.7650

B.180

C.54

D.540

E.1890

39. 7, 42, 210, 840, 2820, 5040

A.42

B.210

C.2820

D.840

E.5040



Ultra Practice Bundle PDF for All Bank Prelims Exams

40. 49, 144, 289, 441, 729, 1024

A.289

B.144

C.1024

D.441

E.729

41. 5, 7, 13, 25, 45, 70

A.7

B.13

C.25

D.45

E.70

42. 10, 19, 37, 73, 140, 289

A.19

B.73

C.140

D.289

E. None of these

43. 298, 294, 433, 850, 2080, 6215

A.6215

B.2080

C.850

D.433

E. None of these

44. 15, 18, 26, 41, 65, 120

A.120

B.65

C.41

D.18

E. None of these

45. 20, 25, 50, 170, 800, 3925

A.25

B.50

C.170

D.800

E.3925

46. 8, 20, 50, 122, 312.5, 781.25

A.20

B.50

C.122

Ultra Practice Bundle PDF for All Bank Prelims Exams

D.312.5

E. None of these

47. 8, 14, 20, 50, 98, 194

A.20

B.50

C.98

D.194

E. None of these

48. 12, 88, 162, 234, 308, 372

A.308

B.372

C.88

D.234

E.162

49. 97, 110, 136, 175, 227, 290

A. 290

B.175

C.110

D.227

E.136

50. 243, 152, 108, 72, 48, 32

A.152

B.108

C.32

D.48

E.72

Solutions and explanations:

1. Answer: C

$$2.5 \times 2 = 5$$

$$5 \times 5 = 25$$

$$25 \times 8 = 200$$

$$200 \times 11 = 2200$$

$$2200 \times 14 = 30800$$

2. Answer: C

$$70 \times 1 - 2 = 68$$



Ultra Practice Bundle PDF for All Bank Prelims Exams

$$68 \times 2 - 3 = 133$$

$$133 \times 3 - 4 = 395$$

$$395 \times 4 - 5 = 1575$$

$$1575 \times 5 - 6 = 7869$$

3. Answer: A

$$643 + 5^3 = 768$$

$$768 + 6^2 = 804$$

$$804 + 7^3 = 1147$$

$$1147 + 8^2 = 1211$$

$$1211 + 9^3 = 1940$$

4. Answer: B

$$8 \times 0.5 + 1 = 5$$

$$5 \times 1 + 1 = 6$$

$$6 \times 1.5 + 1 = 10$$

$$10 \times 2 + 1 = 21$$

$$21 \times 2.5 + 1 = 53.5$$

5. Answer: A

$$339 + 2^1 = 341$$

$$341 + 2^2 = 345$$

$$345 + 2^3 = 353$$

$$353 + 2^4 = 369$$

$$369 + 2^5 = 401$$

6. Answer: A

$$5 \times 2 + 10 = 20$$

$$20 \times 2 + 10 = 50$$

$$50 \times 2 + 10 = 110$$

$$110 \times 2 + 10 = 230$$

$$230 \times 2 + 10 = 470$$

7. Answer: B

$$20 + 5 = 25$$

$$25 - 3 = 22$$

$$22 + 5 = 27$$

$$27 - 3 = 24$$

$$24 + 5 = 29$$

8. Answer: C

$$3 + 1^2 = 4$$

$$4 + 2^2 = 8$$

$$8 + 3^2 = 17$$

$$17 + 4^2 = 33$$

$$33 + 5^2 = 58$$



Ultra Practice Bundle PDF for All Bank Prelims Exams

9. Answer: A

2 22 47 77 **112**

20 25 30 35

10. Answer: E

$0.5 + 1.5 = 2$

$2 + 2 = 4$

$4 + 2.5 = 6.5$

$6.5 + 3 = 9.5$

$9.5 + 3.5 = 13$

11. Answer: B

$513 + 7 = 520$

$520 + 11 = 531$

$531 + 13 = 544$

$544 + 17 = 561$

$561 + 19 = 580$

12. Answer: D

305 336 373 422 **495** 616

31 37 49 73 121

6 12 24 48

13. Answer: C

$15 \times 1 - 1 = 14$

$14 \times 2 - 2 = 26$

$26 \times 3 - 3 = 75$

$75 \times 4 - 4 = 296$

$296 \times 5 - 5 = 1475$

14. Answer: E

$4 \times 3 + 1 = 13$

$13 \times 3 + 2 = 41$

$41 \times 3 + 4 = 127$

$127 \times 3 + 8 = 389$

$389 \times 3 + 16 = 1183$

15. Answer: C

$105 + 11 = 116$

$116 + 15 = 131$

$131 + 17 = 148$

$148 + 19 = 167$

$167 + 21 = 190$

16. Answer: C

$32 + 20 = 52$

$52 + 40 = 92$



Ultra Practice Bundle PDF for All Bank Prelims Exams

$92 + 80 = 172$

$172 + 160 = 332$

$332 + 320 = \mathbf{652}$

17. Answer: A

$256 - 4^2 = 240$

$240 - 5^2 = \mathbf{215}$

$215 - 6^2 = 179$

$179 - 7^2 = 130$

$130 - 8^2 = 66$

18. Answer: B

$32 + 7 = 39$

$39 + 11 = \mathbf{50}$

$50 + 13 = 63$

$63 + 17 = 80$

$80 + 19 = 99$

19. Answer: C

$5^2 - 1 = 24$

$7^2 - 2 = 47$

$9^2 - 3 = 78$

$11^2 - 4 = 117$

$13^2 - 5 = 164$

$15^2 - 6 = \mathbf{219}$

20. Answer: D

$13 * 2 = 26$

$26 * 3 = 78$

$78 * 4 = 312$

$312 * 5 = 1560$

$1560 * 6 = \mathbf{9360}$

21. Answer: A

$8 + (11 + 0) = 19$

$19 + (11 + 5) = 35$

$35 + (11 + 10) = 56$

$56 + (11 + 15) = 82$

$82 + (11 + 20) = \mathbf{113}$

22. Answer: C

$67 + 8^2 + 1 = 132$

$132 + 7^2 + 2 = 183$

$183 + 6^2 + 3 = 222$

$222 + 5^2 + 4 = 251$

$251 + 4^2 + 5 = \mathbf{272}$



Ultra Practice Bundle PDF for All Bank Prelims Exams

23. Answer: B

$$19 + (1 * 2) = 21$$

$$21 + (3 * 4) = 33$$

$$33 + (5 * 8) = 73$$

$$73 + (7 * 16) = \mathbf{185}$$

$$185 + (9 * 32) = 473$$

24. Answer: A

$$13 + 10 \text{ since, } 10 = (5 \times 2) = 23$$

$$23 + 18 \text{ since, } 18 = (9 \times 2) = 41$$

$$41 + 26 \text{ since, } 26 = (13 \times 2) = \mathbf{67}$$

$$67 + 34 \text{ since, } 34 = (17 \times 2) = 101$$

$$101 + 42 \text{ since, } 42 = (21 \times 2) = 143$$

25. Answer: D

$$1.2 * 10 = 12$$

$$12 * 9 = 108$$

$$108 * 8 = \mathbf{864}$$

$$864 * 7 = 6048$$

$$6048 * 6 = 36288$$

26. Answer: A

$$96 + 18^2 = 420$$

$$420 - 17^2 = 131$$

$$131 + 16^2 = \mathbf{387}$$

$$387 - 15^2 = 162$$

$$162 + 14^2 = 358$$

27. Answer: C

$$1 + (5 * 1) = 6$$

$$6 + (5 * 3) = 21$$

$$21 + (5 * 5) = 46$$

$$46 + (5 * 7) = \mathbf{81}$$

$$81 + (5 * 9) = 126$$

28. Answer: C

$$12^2 + 1^2 = 145$$

$$14^2 + 2^2 = 200$$

$$16^2 + 3^2 = 265$$

$$18^2 + 4^2 = 340$$

$$20^2 + 5^2 = 425$$

$$22^2 + 6^2 = \mathbf{520}$$

29. Answer: E

$$13 * 1 + 1 = 14$$

$$14 * 2 + 1 = 29$$



Ultra Practice Bundle PDF for All Bank Prelims Exams

$$29 * 3 + 1 = 88$$

$$88 * 4 + 1 = 353$$

$$353 * 5 + 1 = \mathbf{1766}$$

30. Answer: A

$$343 - 64 = 279$$

$$279 - 32 = 247$$

$$247 - 16 = 231$$

$$231 - 8 = 223$$

$$223 - 4 = \mathbf{219}$$

31. Answer: B

$$1^3 - 1 = 0$$

$$2^3 - 2 = 6$$

$$3^3 - 3 = \mathbf{24}$$

$$4^3 - 4 = 60$$

$$5^3 - 5 = 120$$

32. Answer: A

$$8^3 = 512$$

$$4^2 = \mathbf{16}$$

$$7^3 = 343$$

$$5^2 = 25$$

$$6^3 = 216$$

33. Answer: D

$$3^2 + 3 = 12$$

$$4^2 + 4 = 20$$

$$5^2 + 5 = 30$$

$$6^2 + 6 = \mathbf{42}$$

$$7^2 + 7 = 56$$

34. Answer: D

$$2^3 + 2 = 10$$

$$3^3 - 3 = 24$$

$$4^3 + 4 = 68$$

$$5^3 - 5 = \mathbf{120 \text{ (not 100)}}$$

$$6^3 + 6 = 222$$

35. Answer: D

$$1^2 + 2 = 3$$

$$2^2 + 3 = 7$$

$$3^2 + 4 = 13$$

$$4^2 + 5 = \mathbf{21 \text{ (not 20)}}$$

$$5^2 + 6 = 31$$

36. Answer: A



Ultra Practice Bundle PDF for All Bank Prelims Exams

$$1 + 1^2 = 2 \text{ (not 4)}$$

$$2 + 2^2 = 6$$

$$6 + 3^2 = 15$$

$$15 + 4^2 = 31$$

$$31 + 5^2 = 56$$

$$56 + 6^2 = 92$$

37. Answer: D

$$10 \times 1/2 + 2^1 = 7$$

$$20 \times 1/2 + 2^2 = 14$$

$$30 \times 1/2 + 2^3 = 23$$

$$40 \times 1/2 + 2^4 = 36$$

$$50 \times 1/2 + 2^5 = 57 \text{ (not 55)}$$

$$60 \times 1/2 + 2^6 = 94$$

$$70 \times 1/2 + 2^7 = 163$$

38. Answer: A

$$36 * 2 = 72$$

$$72 * 2.5 = 180$$

$$180 * 3 = 540$$

$$540 * 3.5 = 1890$$

$$1890 * 4 = 7560 \text{ (not 7650)}$$

39. Answer: C

$$7 * 6 = 42$$

$$42 * 5 = 210$$

$$210 * 4 = 840$$

$$840 * 3 = 2520 \text{ (not 2820)}$$

$$2520 * 2 = 5040$$

40. Answer: D

$$7^2 = 49$$

$$12^2 = 144$$

$$17^2 = 289$$

$$22^2 = 484 \text{ (not 441)}$$

$$27^2 = 729$$

$$32^2 = 1024$$

41. Answer: E

$$5 + 1 + 1 = 7$$

$$7 + 4 + 2 = 13$$

$$13 + 9 + 3 = 25$$

$$25 + 16 + 4 = 45$$

$$45 + 25 + 5 = 75 \text{ (not 70)}$$

42. Answer: C



Ultra Practice Bundle PDF for All Bank Prelims Exams

$$10 * 2 - 1 = 19$$

$$19 * 2 - 1 = 37$$

$$37 * 2 - 1 = 73$$

$$73 * 2 - 1 = \mathbf{145 \text{ (not 140)}}$$

$$145 * 2 - 1 = 289$$

43. Answer: B

$$298 * 1 - 4 = 294$$

$$294 * 1.5 - 8 = 433$$

$$433 * 2 - 16 = 850$$

$$850 * 2.5 - 32 = \mathbf{2093 \text{ (not 2080)}}$$

$$2093 * 3 - 64 = 6215$$

44. Answer: A

$$15 + 1 * 3 = 18$$

$$18 + 2 * 4 = 26$$

$$26 + 3 * 5 = 41$$

$$41 + 4 * 6 = 65$$

$$65 + 5 * 7 = \mathbf{100 \text{ (not 120)}}$$

45. Answer: C

$$20 + 5 = 25$$

$$25 + 5^2 = 50$$

$$50 + 5^3 = \mathbf{175 \text{ (not 170)}}$$

$$175 + 5^4 = 800$$

$$800 + 5^5 = 3925$$

46. Answer: C

$$8 * 2.5 = 20$$

$$20 * 2.5 = 50$$

$$50 * 2.5 = \mathbf{125 \text{ (not 122)}}$$

$$125 * 2.5 = 312.5$$

$$312.5 * 2.5 = 781.25$$

47. Answer: A

$$8 * 2 - 2 = 14$$

$$14 * 2 - 2 = \mathbf{26 \text{ (not 20)}}$$

$$26 * 2 - 2 = 50$$

$$50 * 2 - 2 = 98$$

$$98 * 2 - 2 = 194$$

48. Answer: A

$$12 + 76 = 88$$

$$88 + 74 = 162$$

$$162 + 72 = 234$$

$$234 + 70 = \mathbf{304 \text{ (Not 308)}}$$

Ultra Practice Bundle PDF for All Bank Prelims Exams

$$304 + 68 = 372$$

49. Answer: A

$$97 + (13 * 1) = 110$$

$$110 + (13 * 2) = 136$$

$$136 + (13 * 3) = 175$$

$$175 + (13 * 4) = 227$$

$$227 + (13 * 5) = \mathbf{292 \text{ (not 290)}}$$

50. Answer: A

$$243 / 1.5 = \mathbf{162}$$

$$162 / 1.5 = 108$$

$$108 / 1.5 = 72$$

$$72 / 1.5 = 48$$

$$48 / 1.5 = 32$$

5. Quadratic Equation

Directions: In the given question, two equations numbered I and II are given. You have to solve both the equations and mark the appropriate answer

1. I) $x^2 + 5x + 6 = 0$

II) $y^2 + 7y + 12 = 0$

- a) $x > y$
- b) $x \geq y$
- c) $x < y$
- d) $x \leq y$
- e) $x = y$ or the relationship cannot be established

2. I) $x^2 = 784$

II) $y = \sqrt{784}$

- a) if $x > y$
- b) if $x \geq y$
- c) if $x < y$

d) $x \leq y$

e) $x = y$ or the relationship cannot be established

3. I) $5x + 3y = 16$

II) $3x + 2y = 34$

- a) $x > y$
- b) $x \geq y$
- c) $x < y$
- d) $x \leq y$
- e) $x = y$ or the relationship can not be established

4. I. $x^2 + 3x - 18 = 0$

II. $y^2 - 16 = 0$

a) $x > y$



Ultra Practice Bundle PDF for All Bank Prelims Exams

- b) $x < y$
- c) $x \leq y$
- d) $x \geq y$
- e) $x = y$ or relationship cannot be determined

5. I) $6x + 3y = 18$

II) $3x + 4y = 15$

- a) if $x < y$
- b) if $x > y$
- c) if $x \leq y$
- d) if $x \geq y$
- e) $x = y$ or if the relationship cannot be established

6. I. $x^2 + 15x - 76 = 0$

II. $y^2 + 20y - 96 = 0$

- a) $x < y$
- b) $x > y$
- c) $x = y$ OR the relationship cannot be determined
- d) $x \geq y$
- e) $x \leq y$

7. I. $x^2 - 7x - 98 = 0$

II. $y^2 + 16y - 57 = 0$

- a) $x < y$
- b) $x > y$
- c) $x = y$ OR the relationship cannot be determined
- d) $x \geq y$
- e) $x \leq y$

8. I. $x^2 - 3x - 10 = 0$

II. $y^2 - 37y + 330 = 0$

- a) $x < y$
- b) $x > y$
- c) $x \leq y$
- d) $x \geq y$
- e) $x = y$ or relationship cannot be established

9. I. $x^2 - 5x + 4 = 0$

II. $y^2 + 23y - 24 = 0$

- a) $x < y$
- b) $x > y$
- c) $x \leq y$
- d) $x \geq y$
- e) $x = y$ or relationship cannot be established

10. I. $x^2 - 27x + 180 = 0$

II. $y^2 - 5y - 84 = 0$

- a) $x > y$
- b) $x < y$
- c) $x = y$ or the relationship cannot be established
- d) $x \geq y$
- e) $x \leq y$

11. I. $x^2 - 21x + 108 = 0$

II. $y^2 - 24y + 128 = 0$

- a) $x > y$
- b) $x < y$
- c) $x = y$ or the relationship cannot be established
- d) $x \geq y$



Ultra Practice Bundle PDF for All Bank Prelims Exams

e) $x \leq y$

12. I. $x^2 - 16x + 63 = 0$

II. $y^2 - 2y - 24 = 0$

a) $x > y$

b) $x < y$

c) $x = y$ or the relationship cannot be established

d) $x \geq y$

e) $x \leq y$

13. I. $x^2 + 17x + 60 = 0$

II. $y^2 - 3y - 40 = 0$

a) $x > y$

b) $x < y$

c) $x = y$ or the relationship cannot be established

d) $x \geq y$

e) $x \leq y$

14. I. $x^2 - 7x - 18 = 0$

II. $y^2 - 20y + 99 = 0$

a) $x < y$

b) $x > y$

c) $x = y$ OR the relationship cannot be determined

d) $x \geq y$

e) $x \leq y$

15. I. $x^2 + 6x + 8 = 0$

II. $y^2 - 3y - 10 = 0$

a) $x < y$

b) $x > y$

c) $x \leq y$

d) $x \geq y$

e) $x = y$ or relationship cannot be established

16. I. $x^2 - 19x - 66 = 0$

II. $y^2 + 20y + 64 = 0$

a) $x < y$

b) $x > y$

c) $x \leq y$

d) $x \geq y$

e) $x = y$ or relationship cannot be established

17. I. $x^2 - 22x + 72 = 0$

II. $y^2 - 32y + 247 = 0$

a) $x < y$

b) $x > y$

c) $x \leq y$

d) $x \geq y$

e) $x = y$ or relationship cannot be established

18. I. $x^2 + 6x - 352 = 0$

II. $y^2 + 25y + 156 = 0$

a) $x < y$

b) $x > y$

c) $x \leq y$

d) $x \geq y$

e) $x = y$ or relationship cannot be established

19. I. $x^2 - 24x + 128 = 0$

II. $y^2 + 7y - 120 = 0$



Ultra Practice Bundle PDF for All Bank Prelims Exams

- a) $x > y$
- b) $x < y$
- c) $x = y$ or the relationship cannot be established
- d) $x \geq y$
- e) $x \leq y$

20. I. $x^2 + 28x + 195 = 0$

II. $y^2 + 26y + 168 = 0$

- a) $x > y$
- b) $x < y$
- c) $x = y$ or the relationship cannot be established
- d) $x \geq y$
- e) $x \leq y$

21. I. $x^2 - 6x - 160 = 0$

II. $y^2 - 30y + 224 = 0$

- a) $x > y$
- b) $x < y$
- c) $x = y$ or the relationship cannot be established
- d) $x \geq y$
- e) $x \leq y$

22. I. $x^2 - 26x + 165 = 0$

II. $y^2 - 24y + 143 = 0$

- a) $x > y$
- b) $x < y$
- c) $x = y$ or the relationship cannot be established
- d) $x \geq y$
- e) $x \leq y$

23. I. $x^2 + 2x - 15 = 0$

II. $y^2 - 15y + 44 = 0$

- a) $x > y$
- b) $x < y$
- c) $x = y$ or the relationship cannot be established \times
- d) $x \geq y$
- e) $x \leq y$

24. I. $x^2 - 12x + 32 = 0$

II. $y^2 - y - 12 = 0$

- a) $x > y$
- b) $x < y$
- c) $x = y$ or the relationship cannot be established
- d) $x \geq y$
- e) $x \leq y$

25. I. $x^2 - 12x + 27 = 0$

II. $y^2 - 3y - 18 = 0$

- a) $x > y$
- b) $x < y$
- c) $x = y$ or the relationship cannot be established
- d) $x \geq y$
- e) $x \leq y$

26. I. $x^2 - 16x + 55 = 0$

II. $y^2 - 15y + 56 = 0$

- a) $x > y$
- b) $x < y$
- c) $x = y$ or the relationship cannot be established



Ultra Practice Bundle PDF for All Bank Prelims Exams

- d) $x \geq y$
e) $x \leq y$
- 27. I. $x^2 - 20x + 96 = 0$**
II. $y^2 + y - 42 = 0$
- a) $x > y$
b) $x < y$
c) $x = y$ or the relationship cannot be established
d) $x \geq y$
e) $x \leq y$
- 28. I. $x^2 + 13x - 198 = 0$**
II. $y^2 - 11y - 102 = 0$
- a) $x < y$
b) $x > y$
c) $x = y$ OR the relationship cannot be determined
d) $x \geq y$
e) $x \leq y$
- 29. I. $x^2 + 7x - 8 = 0$**
II. $y^2 - 21y + 108 = 0$
- a) $x < y$
b) $x > y$
c) $x = y$ OR the relationship cannot be determined
d) $x \geq y$
e) $x \leq y$
- 30. I. $x^2 - 19x + 84 = 0$**
II. $y^2 + 14y + 45 = 0$
- a) $x < y$
- b) $x > y$
c) $x = y$ OR the relationship cannot be determined
d) $x \geq y$
e) $x \leq y$
- 31. I. $x^2 - 8x + 12 = 0$**
II. $y^2 + 6y + 5 = 0$
- a) $x \geq y$
b) $y \geq x$
c) Relationships cannot be established between x & y
d) $x > y$
e) $x < y$
- 32. $x^2 - 2x + 1 = 0$**
 $y^2 - 6y + 9 = 0$
- a) $x < y$
b) $x > y$
c) $x \leq y$
d) $x \geq y$
e) $x = y$ or relationship between x and y cannot be established
- 33. I $x^2 + 6x + 9 = 0$**
II $y^2 + 7y + 12 = 0$
- a) $x > y$
b) $x \geq y$
c) $x < y$
d) $x \leq y$
e) $x = y$ or the relationship can't be established.
- 34. I $x^2 - 8x + 15 = 0$**



Ultra Practice Bundle PDF for All Bank Prelims Exams

II. $y^2 + 14y + 24 = 0$

- a) $x > y$
- b) $x \geq y$
- c) $x < y$
- d) $x \leq y$
- e) $x = y$ or relationship between x and y cannot be established

35. I. $x^2 - 9x - 136 = 0$

II. $y^2 + 18y - 63 = 0$

- a) $x < y$
- b) $x > y$
- c) $x = y$ OR the relationship cannot be determined
- d) $x \geq y$
- e) $x \leq y$

36. $x^2 - x - 6 = 0$

$y^2 + 2y - 3 = 0$

- a) $x < y$
- b) $x > y$
- c) $x \leq y$
- d) $x \geq y$
- e) $x = y$ or relationship between x and y cannot be established

37. I. $x^2 + 17x + 70 = 0$

II. $y^2 - 7y - 30 = 0$

- a) $x < y$
- b) $x > y$
- c) $x \leq y$

d) $x \geq y$

- e)
- $x = y$
- or relationship cannot be established

38. I. $a^2 - 784 = 0$

II. $b^2 - 24b = 0$

- a) $a < b$
- b) $a > b$
- c) $a \leq b$
- d) $a \geq b$
- e) $a = b$ or the relationship cannot be determined

39. I. $a = \sqrt{1225}$

II. $b^2 = 1225$

- a) $a > b$
- b) $a < b$
- c) $a \geq b$
- d) $a \leq b$
- e) $a = b$ or relation cannot be established

40. I. $a^2 - 64 = 0$

II. $9b^2 - 729 = 0$

- a) $a < b$
- b) $a > b$
- c) $a \leq b$
- d) $a \geq b$
- e) $a = b$ or the relationship cannot be determined

41. I. $x^2 - 22x + 120 = 0$

II. $y^2 - 3y - 130 = 0$

- a)
- $x < y$



Ultra Practice Bundle PDF for All Bank Prelims Exams

- b) $x > y$
- c) $x \leq y$
- d) $x \geq y$
- e) $x = y$ or relationship cannot be established

42. I) $x^2 - 5x + 6 = 0$

II) $y^4 - 5y^2 + 6 = 0$

- a) $x > y$
- b) $x \geq y$
- c) $x < y$
- d) $x = y$ or Relationship between x and y cannot be determined
- e) $x \leq y$

43. I. $4x^2 - 9x + 2 = 0$

II. $y^2 + 29y - 62 = 0$

- a) $x < y$
- b) $x > y$
- c) $x = y$ OR the relationship cannot be determined
- d) $x \geq y$
- e) $x \leq y$

44. I. $x^2 - 17x + 60 = 0$

II. $y^2 - 23y + 120 = 0$

- a) $x > y$
- b) $x < y$
- c) $x = y$ or the relationship cannot be established
- d) $x \geq y$
- e) $x \leq y$

45. I. $x^2 - x - 56 = 0$

II. $y^2 - 15y + 56 = 0$

- a) $x > y$
- b) $x < y$
- c) $x = y$ or the relationship cannot be established
- d) $x \geq y$
- e) $x \leq y$

46. I. $x^2 - 88 = 273$

II. $y = \sqrt{361}$

- a) $x > y$
- b) $x < y$
- c) $x = y$ or the relationship cannot be established
- d) $x \geq y$
- e) $x \leq y$

47. I. $x^2 - 23x + 132 = 0$

II. $y^2 - 20y + 100 = 0$

- a) $x > y$
- b) $x < y$
- c) $x = y$ or the relationship cannot be established
- d) $x \geq y$
- e) $x \leq y$

48. I. $x^2 + 3x - 88 = 0$

II. $y^2 - 33y + 242 = 0$

- a) $x > y$
- b) $x < y$
- c) $x = y$ or the relationship cannot be established
- d) $x \geq y$

Ultra Practice Bundle PDF for All Bank Prelims Exams

e) $x \leq y$

49. I. $x^2 + 5x + 6 = 0$

II. $y^2 - 19y - 42 = 0$

a) $x < y$

b) $x > y$

c) $x \leq y$

d) $x \geq y$

e) $x = y$ or relationship cannot be established

50. I. $x^2 + 18x + 80 = 0$

II. $y^2 + 29y + 190 = 0$

a) $x < y$

b) $x > y$

c) $x \leq y$

d) $x \geq y$

e) $x = y$ or relationship cannot be established

Solution with Explanation

1. Answer: B)

Solving equation I

$$x + 5x + 6 = 0$$

$$x + 2x + 3x + 6 = 0$$

$$\Rightarrow x(x + 2) + 3(x + 2) = 0$$

$$\Rightarrow (x + 3)(x + 2) = 0$$

$$\Rightarrow x = -3 \text{ or } -2$$

Solving equation II

$$y + 7y + 12 = 0$$

$$y + 4y + 3y + 12 = 0$$

$$\Rightarrow y(y + 4) + 3(y + 4) = 0$$

$$\Rightarrow (y + 3)(y + 4) = 0$$

$$\Rightarrow y = -3 \text{ or } -4$$

$$\therefore x \geq y$$

2. Answer: D)

As per the given data,

From I)

$$\Rightarrow x^2 = 784$$

$$\Rightarrow x = \pm 28$$

From II)

$$\Rightarrow y = \sqrt{(784)} = 28$$

\therefore From the above, we can say $x \leq y$

3. Answer: C)

As per the given data,

From I)

$$\Rightarrow 5x + 3y = 16$$

Multiply 3 on both sides, we get

$$\Rightarrow 15x + 9y = 48 \dots \text{equation (1)}$$

From II)

$$\Rightarrow 3x + 2y = 34$$

Multiply 5 on both sides, we get

$$\Rightarrow 15x + 10y = 170 \dots \text{equation (2)}$$

Subtract equation (1) from equation (2), we get

$$\Rightarrow -y = -122$$



Ultra Practice Bundle PDF for All Bank Prelims Exams

$$\Rightarrow y = 122$$

Substitute $y = 122$ in equation (1)

$$\Rightarrow 15x + 9 \times (122) = 48$$

$$\Rightarrow 15x = 48 - 1098$$

$$\Rightarrow x = -1050/15 = -70$$

$$\therefore x < y$$

4. Answer: E)

As per the given data,

By solving $x^2 + 3x - 18 = 0$, we get

$$\Rightarrow x^2 + 3x - 18 = 0$$

$$\Rightarrow x^2 + 6x - 3x - 18 = 0$$

$$\Rightarrow x(x + 6) - 3(x + 6) = 0$$

$$\Rightarrow (x - 3)(x + 6) = 0$$

$$\Rightarrow x = 3 \text{ and } x = -6$$

Also by solving $y^2 - 16 = 0$

$$\Rightarrow y^2 - 4^2 = 0$$

$$\Rightarrow y = \pm 4$$

When $x = 3$ and $y = 4$, then $x < y$

When $x = 3$ and $y = -4$, then $x > y$

When $x = -6$ and $y = 4$, then $x < y$

When $x = -6$ and $y = -4$, then $x < y$

\therefore Relationship cannot be determined

5. Answer: A)

From the given data,

$$\Rightarrow 6x + 3y = 18 \text{ - - - - equation (1)}$$

Also given that $3x + 4y = 15$

Multiply 2 on both sides, we get

$$\Rightarrow 2(3x + 4y = 15)$$

$$\Rightarrow 6x + 8y = 30 \text{ - - - - equation (2)}$$

Subtract equation (1) from equation (2), we get

$$\Rightarrow 5y = 12$$

$$\Rightarrow y = 2.4$$

Substitute $y = 2.4$ in equation (1)

$$\Rightarrow 6x + 3(2.4) = 18$$

$$\Rightarrow 6x = 10.8$$

$$\Rightarrow x = 1.8$$

$$\therefore x < y$$

6. Answer: C)

I. $x^2 + 15x - 76 = 0$

$$\Rightarrow x^2 + 19x - 4x - 76 = 0$$

$$\Rightarrow x(x + 19) - 4(x + 19) = 0$$

$$\Rightarrow (x + 19)(x - 4) = 0$$

Then, $x = -19$ or $x = +4$

II. $y^2 + 20y - 96 = 0$

$$\Rightarrow y^2 + 24y - 4y - 96 = 0$$

$$\Rightarrow y(y + 24) - 4(Y + 24) = 0$$

$$\Rightarrow (y + 24)(y - 4) = 0$$

Then, $y = -24$ or $y = +4$

So, when $x = +4$, $x > y$ for $y = -24$ and $x = y$ for $y = +4$

And when $x = -19$, $x > y$ for $y = -24$ and $x < y$ for $y = +4$

\therefore So, we can observe that no clear relationship cannot be determined between x and y .



Ultra Practice Bundle PDF for All Bank Prelims Exams

7. Answer: C)

I. $x^2 - 7x - 98 = 0$

$\Rightarrow x^2 - 14x + 7x - 98 = 0$

$\Rightarrow x(x - 14) + 7(x - 14) = 0$

$\Rightarrow (x - 14)(x + 7) = 0$

Then, $x = +14$ or $x = -7$

II. $y^2 + 16y - 57 = 0$

$\Rightarrow y^2 + 19y - 3y - 57 = 0$

$\Rightarrow y(y + 19) - 3(y + 19) = 0$

$\Rightarrow (y + 19)(y - 3) = 0$

Then, $y = -19$ or $y = +3$ So, when $x = +14$, $x > y$ for $y = -19$ and $x > y$ for $y = +3$ And when $x = -7$, $x > y$ for $y = -19$ and $x < y$ for $y = +3$ \therefore So, we can observe that no clear relationship cannot be determined between x and y .**8. Answer: A)**

From equation I:

$x^2 - 3x - 10 = (x + 2)(x - 5) = 0$

$\Rightarrow x = -2, 5$

From equation II:

$y^2 - 37y + 330 = (y - 22)(y - 15) = 0$

$\Rightarrow y = 22, 15$

	X = -2	X = 5
Y = 22	$x < y$	$x < y$
Y = 15	$x < y$	$x < y$

So, $x < y$ **9. Answer: D)**

From equation I:

$x^2 - 5x + 4 = (x - 4)(x - 1) = 0$

$\Rightarrow x = 4, 1$

From equation II:

$y^2 + 23y - 24 = (y + 24)(y - 1) = 0$

$\Rightarrow y = -24, 1$

	X = 4	X = 1
Y = -24	$x > y$	$x > y$
Y = 1	$x > y$	$x = y$

So, $x \geq y$ **10. Answer: D)**

From I:

$x^2 - 27x + 180 = 0$

$x^2 - 12x - 15x + 180 = 0$

$x(x - 12) - 15(x - 12) = 0$

$(x - 12)(x - 15) = 0$

$x = 12, 15$

From II:

$y^2 - 5y - 84 = 0$

$y^2 - 12y + 7y - 84 = 0$

$y(y - 12) + 7(y - 12) = 0$

$(y - 12)(y + 7) = 0$

$y = 12, -7$

X	Relation	y
12	=	12
15	>	12
12	>	-7
15	>	-7

Therefore, $x \geq y$ **11. Answer: C)**



Ultra Practice Bundle PDF for All Bank Prelims Exams

From I:

$$x^2 - 21x + 108 = 0$$

$$x^2 - 12x - 9x + 108 = 0$$

$$x(x - 12) - 9(x - 12) = 0$$

$$(x - 12)(x - 9) = 0$$

$$x = 9, 12$$

From II:

$$y^2 - 24y + 128 = 0$$

$$y^2 - 16y - 8y + 128 = 0$$

$$y(y - 16) - 8(y - 16) = 0$$

$$(y - 16)(y - 8) = 0$$

$$y = 8, 16$$

X	Relation	y
9	>	8
9	<	16
12	>	8
12	<	16

Therefore, no relation can be established between x and y

12. Answer: A)

From I:

$$x^2 - 16x + 63 = 0$$

$$x^2 - 7x - 9x + 63 = 0$$

$$x(x - 7) - 9(x - 7) = 0$$

$$(x - 7)(x - 9) = 0$$

$$x = 7, 9$$

From II:

$$y^2 - 2y - 24 = 0$$

$$y^2 - 6y + 4y - 24 = 0$$

$$y(y - 6) + 4(y - 6) = 0$$

$$(y - 6)(y + 4) = 0$$

$$y = 6, -4$$

X	Relation	y
9	>	6
9	>	-4
7	>	6
7	>	-4

Therefore, $x > y$

13. Answer: E)

From I:

$$x^2 + 17x + 60 = 0$$

$$x^2 + 5x + 12x + 60 = 0$$

$$x(x + 5) + 12(x + 5) = 0$$

$$(x + 5)(x + 12) = 0$$

$$x = -5, -12$$

From II:

$$y^2 - 3y - 40 = 0$$

$$y^2 - 8y + 5y - 40 = 0$$

$$y(y - 8) + 5(y - 8) = 0$$

$$(y - 8)(y + 5) = 0$$

$$y = 8, -5$$

X	Relation	y
-5	<	8
-5	=	-5
-12	<	8
-12	<	-5

Therefore, $x \leq y$

14. Answer: E)



Ultra Practice Bundle PDF for All Bank Prelims Exams

I. $x^2 - 7x - 18 = 0$

$$\Rightarrow x^2 - 9x + 2x - 18 = 0$$

$$\Rightarrow x(x - 9) + 2(x - 9) = 0$$

$$\Rightarrow (x - 9)(x + 2) = 0$$

Then, $x = +9$ or $x = -2$

II. $y^2 - 20y + 99 = 0$

$$\Rightarrow y^2 - 11y - 9y + 99 = 0$$

$$\Rightarrow y(y - 11) - 9(y - 11) = 0$$

$$\Rightarrow (y - 11)(y - 9) = 0$$

Then, $y = +11$ or $y = +9$ So, when $x = +9$, $x < y$ for $y = +11$ and $x = y$ for $y = +9$ And when $x = -2$, $x < y$ for $y = +11$ and $x < y$ for $y = +9$ \therefore So, we can clearly observe that $x \leq y$.**15. Answer: C)**

From equation I:

$$x^2 + 6x + 8 = (x + 2)(x + 4) = 0$$

$$\Rightarrow x = -2, -4$$

From equation II:

$$y^2 - 3y - 10 = (y - 5)(y + 2) = 0$$

$$\Rightarrow y = 5, -2$$

	X = -2	X = -4
Y = 5	x < y	x < y
Y = -2	x = y	x < y

So, $x \leq y$ **16. Answer: B)**

From equation I:

$$x^2 - 19x - 66 = (x - 22)(x + 3) = 0$$

$$\Rightarrow x = 22, -3$$

From equation II:

$$y^2 + 20y + 64 = (y + 4)(y + 16) = 0$$

$$\Rightarrow y = -4, -16$$

	X = 22	X = -3
Y = -4	x > y	x > y
Y = -16	x > y	x > y

So, $x > y$ **17. Answer: E)**

From equation I:

$$x^2 - 22x + 72 = (x - 18)(x - 4) = 0$$

$$\Rightarrow x = 18, 4$$

From equation II:

$$y^2 - 32y + 247 = (y - 19)(y - 13) = 0$$

$$\Rightarrow y = 19, 13$$

	X = 18	X = 4
Y = 19	x < y	x < y
Y = 13	x > y	x < y

So, relationship cannot be established between x and y **18. Answer: E)**

From equation I:

$$x^2 + 6x - 352 = (x + 22)(x - 16) = 0$$

$$\Rightarrow x = -22, 16$$

From equation II:

$$y^2 + 25y + 156 = (y + 13)(y + 12) = 0$$

$$\Rightarrow y = -13, -12$$

	X = -22	X = 16
Y = -13	x < y	x > y
Y = -12	x < y	x > y



Ultra Practice Bundle PDF for All Bank Prelims Exams

So, relationship cannot be established between x and y

19. Answer: D)

From I:

$$x^2 - 24x + 128 = 0$$

$$x^2 - 8x - 16x + 128 = 0$$

$$x(x - 8) - 16(x - 8) = 0$$

$$(x - 8)(x - 16) = 0$$

$$x = 8, 16$$

From II:

$$y^2 + 7y - 120 = 0$$

$$y^2 + 15y - 8y - 120 = 0$$

$$y(y + 15) - 8(y + 15) = 0$$

$$(y + 15)(y - 8) = 0$$

$$y = -15, 8$$

X	Relation	Y
8	=	8
8	>	-15
16	>	8
16	>	-15

So, $x \geq y$

20. Answer: C)

From I:

$$x^2 + 28x + 195 = 0$$

$$x^2 + 13x + 15x + 195 = 0$$

$$x(x + 13) + 15(x + 13) = 0$$

$$(x + 13)(x + 15) = 0$$

$$x = -13, -15$$

From II:

$$y^2 + 26y + 168 = 0$$

$$y^2 + 12y + 14y + 168 = 0$$

$$y(y + 12) + 14(y + 12) = 0$$

$$(y + 12)(y + 14) = 0$$

$$y = -12, -14$$

X	Relation	Y
-13	<	-12
-13	>	-14
-15	<	-12
-15	<	-14

So, no relation can be established between x and y.

21. Answer: C)

From I:

$$x^2 - 6x - 160 = 0$$

$$x^2 + 10x - 16x - 160 = 0$$

$$x(x + 10) - 16(x + 10) = 0$$

$$(x + 10)(x - 16) = 0$$

$$x = -10, 16$$

From II:

$$y^2 - 30y + 224 = 0$$

$$y^2 - 14y - 16y + 224 = 0$$

$$y(y - 14) - 16(y - 14) = 0$$

$$(y - 14)(y - 16) = 0$$

$$y = 14, 16$$

X	Relation	y
-10	<	14
-10	<	16
16	>	14
16	=	16

So, no relation can be established between x and y.



Ultra Practice Bundle PDF for All Bank Prelims Exams

22. Answer: C)

From I:

$$x^2 - 26x + 165 = 0$$

$$x^2 - 11x - 15x + 165 = 0$$

$$x(x - 11) - 15(x - 11) = 0$$

$$(x - 11)(x - 15) = 0$$

$$x = 11, 15$$

From II:

$$y^2 - 24y + 143 = 0$$

$$y^2 - 13y - 11y + 143 = 0$$

$$y(y - 13) - 11(y - 13) = 0$$

$$(y - 13)(y - 11) = 0$$

$$y = 11, 13$$

X	Relation	y
11	=	11
11	<	13
15	>	11
15	>	13

So, no relation can be established between x and y.

23. Answer: B)

From I:

$$x^2 + 2x - 15 = 0$$

$$x^2 - 3x + 5x - 15 = 0$$

$$x(x - 3) + 5(x - 3) = 0$$

$$(x - 3)(x + 5) = 0$$

$$x = 3, -5$$

From II:

$$y^2 - 15y + 44 = 0$$

$$y^2 - 4y - 11y + 44 = 0$$

$$y(y - 4) - 11(y - 4) = 0$$

$$(y - 4)(y - 11) = 0$$

$$y = 4, 11$$

X	Relation	y
3	<	4
3	<	11
-5	<	4
-5	<	11

So, $x < y$ **24. Answer: D)**

From I:

$$x^2 - 12x + 32 = 0$$

$$x^2 - 8x - 4x + 32 = 0$$

$$x(x - 8) - 4(x - 8) = 0$$

$$(x - 8)(x - 4) = 0$$

$$x = 8, 4$$

From II:

$$y^2 - y - 12 = 0$$

$$y^2 + 3y - 4y - 12 = 0$$

$$y(y + 3) - 4(y + 3) = 0$$

$$(y + 3)(y - 4) = 0$$

$$y = -3, 4$$

X	Relation	y
8	>	-3
8	>	4
4	>	-3
4	=	4

So, $x \geq y$ **25. Answer: C)**



Ultra Practice Bundle PDF for All Bank Prelims Exams

From I:

$$x^2 - 12x + 27 = 0$$

$$x^2 - 3x - 9x + 27 = 0$$

$$x(x - 3) - 9(x - 3) = 0$$

$$(x - 3)(x - 9) = 0$$

$$x = 3, 9$$

From II:

$$y^2 - 3y - 18 = 0$$

$$y^2 + 3y - 6y - 18 = 0$$

$$y(y + 3) - 6(y + 3) = 0$$

$$(y + 3)(y - 6) = 0$$

$$y = -3, 6$$

X	Relation	y
3	>	-3
3	<	6
9	>	-3
9	>	6

So, no relationship can be established between x and y.

26. Answer: C)

From I:

$$x^2 - 16x + 55 = 0$$

$$x^2 - 11x - 5x + 55 = 0$$

$$x(x - 11) - 5(x - 11) = 0$$

$$(x - 5)(x - 11) = 0$$

$$x = 5, 11$$

From II:

$$y^2 - 15y + 56 = 0$$

$$y^2 - 7y - 8y + 56 = 0$$

$$y(y - 7) - 8(y - 7) = 0$$

$$(y - 7)(y - 8) = 0$$

$$y = 7, 8$$

X	Relation	y
5	<	7
5	<	8
11	>	7
11	>	8

So, no relationship can be established between x and y.

27. Answer: A)

From I:

$$x^2 - 20x + 96 = 0$$

$$x^2 - 8x - 12x + 96 = 0$$

$$x(x - 8) - 12(x - 8) = 0$$

$$(x - 8)(x - 12) = 0$$

$$x = 8, 12$$

From II:

$$y^2 + y - 42 = 0$$

$$y^2 + 7y - 6y - 42 = 0$$

$$y(y + 7) - 6(y + 7) = 0$$

$$(y + 7)(y - 6) = 0$$

$$y = -7, 6$$

X	Relation	Y
8	>	-7
12	>	-7
8	>	6
12	>	6

So, $x > y$

28. Answer: C)

I. $x^2 + 13x - 198 = 0$



Ultra Practice Bundle PDF for All Bank Prelims Exams

$$\Rightarrow x^2 + 22y - 9y - 198 = 0$$

$$\Rightarrow x(x + 22) - 9(y + 22) = 0$$

$$\Rightarrow (x + 22)(x - 9) = 0$$

Then, $x = -22$ or $x = +9$

$$\text{II. } y^2 - 11y - 102 = 0$$

$$\Rightarrow y^2 - 17y + 6y - 102 = 0$$

$$\Rightarrow y(y - 17) + 6(y - 17) = 0$$

$$\Rightarrow (y - 17)(y + 6) = 0$$

Then, $y = +17$ or $y = -6$

So, when $x = -22$, $x < y$ for $y = +17$ and $x < y$ for $y = -6$

And when $x = +9$, $x < y$ for $y = +17$ and $x > y$ for $y = -6$

\therefore So, we can observe that no clear relationship cannot be determined between x and y .

29. Answer: A)

$$\text{I. } x^2 + 7x - 8 = 0$$

$$\Rightarrow x^2 + 8x - x - 8 = 0$$

$$\Rightarrow x(x + 8) - 1(x + 8) = 0$$

$$\Rightarrow (x + 8)(x - 1) = 0$$

Then, $x = -8$ or $x = +1$

$$\text{II. } y^2 - 21y + 108 = 0$$

$$\Rightarrow y^2 - 12y - 9y + 108 = 0$$

$$\Rightarrow y(y - 12) - 9(y - 12) = 0$$

$$\Rightarrow (y - 12)(y - 9) = 0$$

Then, $y = +12$ or $y = +9$

So, when $x = -8$, $x < y$ for $y = +12$ and $x < y$ for $y = +9$

And when $x = +1$, $x < y$ for $y = +12$ and $x < y$ for $y = +9$

So, we can observe that $x < y$.

30. Answer: B)

$$\text{I. } x^2 - 19x + 84 = 0$$

$$\Rightarrow x^2 - 12x - 7x + 84 = 0$$

$$\Rightarrow x(x - 12) - 7(x - 12) = 0$$

$$\Rightarrow (x - 12)(x - 7) = 0$$

Then, $x = +12$ or $x = +7$

$$\text{II. } y^2 + 14y + 45 = 0$$

$$\Rightarrow y^2 + 9y + 5y + 45 = 0$$

$$\Rightarrow y(y + 9) + 5(y + 9) = 0$$

$$\Rightarrow (y + 9)(y + 5) = 0$$

Then, $y = -9$ or $y = -5$

So, when $x = +12$, $x > y$ for $y = -9$ and $x > y$ for $y = -5$

And when $x = +7$, $x > y$ for $y = -9$ and $x > y$ for $y = -5$

\therefore So, we can observe that $x > y$.

31. Answer: D)

$$\text{I. } x^2 - 8x + 12 = 0$$

$$\Rightarrow x^2 - 6x - 2x + 12 = 0$$

$$\Rightarrow x(x - 6) - 2(x - 6) = 0$$

$$\Rightarrow (x - 6)(x - 2) = 0$$

Then, $x = 6$ or $x = 2$

$$\text{II. } y^2 + 6y + 5 = 0$$

$$\Rightarrow y^2 + 5y + y + 5 = 0$$

$$\Rightarrow y(y + 5) + 1(y + 5) = 0$$

$$\Rightarrow (y + 5)(y + 1) = 0$$

Then, $y = -5$ or $y = -1$



Ultra Practice Bundle PDF for All Bank Prelims Exams

∴ As, we can observe that both of the values of x are positive and both of the values of y are negative then we can clearly say that $x > y$.

32. Answer: A)

For eq 1:

$$x^2 - 2x + 1 = 0$$

$$\Rightarrow x^2 - x - x + 1 = 0$$

$$\Rightarrow (x - 1)^2 = 0$$

$$\therefore x = 1$$

For eq 2:

$$y^2 - 6y + 9 = 0$$

$$\Rightarrow y^2 - 3y - 3y + 9 = 0$$

$$\Rightarrow (y - 3)^2 = 0$$

$$\therefore y = 3$$

When $x = 1, y = 3$

∴ x and y are related as $x < y$

33. Answer: B)

From the given data,

$$\Rightarrow x^2 + 6x + 9 = 0$$

$$\Rightarrow x^2 + 3x + 3x + 9 = 0$$

$$\Rightarrow x(x + 3) + 3(x + 3) = 0$$

$$\Rightarrow (x + 3)(x + 3) = 0$$

$$\therefore x = -3$$

Also given that $y^2 + 7y + 12 = 0$

$$\Rightarrow y^2 + 3y + 4y + 12 = 0$$

$$\Rightarrow y(y + 3) + 4(y + 3) = 0$$

$$\Rightarrow (y + 3)(y + 4) = 0$$

$$\therefore y = -3 \text{ and } y = -4$$

When $x = -3$ and $y = -3$, then $x = y$

$x = -3$ and $y = -4$, then $x > y$

$$\therefore x \geq y$$

34. Answer: A)

From the given data,

$$\Rightarrow x^2 - 8x + 15 = 0$$

$$\Rightarrow x^2 - 3x - 5x + 15 = 0$$

$$\Rightarrow x(x - 3) - 5(x - 3) = 0$$

$$\Rightarrow (x - 3)(x - 5) = 0$$

$$\therefore x = 3 \text{ and } x = 5$$

Also given that $y^2 + 14y + 24 = 0$

$$\Rightarrow y^2 + 12y + 2y + 24 = 0$$

$$\Rightarrow y(y + 12) + 2(y + 12) = 0$$

$$\Rightarrow (y + 2)(y + 12) = 0$$

$$\Rightarrow y = -2 \text{ and } y = -12$$

∴ When $x = 3$ and $y = -2$, then $x > y$

When $x = 3$ and $y = -12$, then $x > y$

When $x = 5$ and $y = -2$, then $x > y$

When $x = 5$ and $y = -12$, then $x > y$

$$\therefore x > y$$

35. Answer: C)

$$\text{I. } x^2 - 9x - 136 = 0$$

$$\Rightarrow x^2 - 17x + 8x - 136 = 0$$

$$\Rightarrow x(x - 17) + 8(x - 17) = 0$$

$$\Rightarrow (x - 17)(x + 8) = 0$$



Ultra Practice Bundle PDF for All Bank Prelims Exams

Then, $x = + 17$ or $x = - 8$

II. $y^2 + 18y - 63 = 0$

$\Rightarrow y^2 + 21y - 3y - 63 = 0$

$\Rightarrow y(y + 21) - 3(y + 21) = 0$

$\Rightarrow (y + 21)(y - 3) = 0$

Then, $y = - 21$ or $y = + 3$

So, when $x = + 17$, $x > y$ for $y = - 21$ and $x > y$ for $y = + 3$

And when $x = - 8$, $x > y$ for $y = - 21$ and $x < y$ for $y = + 3$

\therefore So, we can observe that no clear relationship cannot be determined between x and y .

36. Answer: E)

For eq 1:

$x^2 - x - 6 = 0$

$\Rightarrow x^2 + 2x - 3x - 6 = 0$

$\Rightarrow (x + 2)(x - 3) = 0$

$\therefore x = -2$ or $x = 3$

For eq 2:

$y^2 + 2y - 3 = 0$

$\Rightarrow y^2 + 3y - y - 3 = 0$

$\Rightarrow (y + 3)(y - 1) = 0$

$\therefore y = -3$ or $y = 1$

When $x = -2$, $y = -3$, then $x > y$

When $x = -2$, $y = 1$, then $x < y$

When $x = 3$, $y = -3$, then $x > y$

When $x = 3$, $y = 1$, then $x > y$

\therefore No relation is obtained between x and y

37. Answer: A)

From equation I:

$x^2 + 17x + 70 = (x + 10)(x + 7) = 0$

$\Rightarrow x = -10, -7$

From equation II:

$y^2 - 7y - 30 = (y - 10)(y + 3) = 0$

$\Rightarrow y = 10, -3$

	$X = -10$	$X = -7$
$Y = 10$	$x < y$	$x < y$
$Y = -3$	$x < y$	$x < y$

So, $x < y$

38. Answer: E)

I. $a^2 - 784 = 0$

$\Rightarrow a^2 - 28^2 = 0$

\Rightarrow Use: $(a^2 - b^2) = (a - b)(a + b)$

$\Rightarrow (a + 28)(a - 28) = 0$

Then, $a = (-28)$ or $a = (28)$

II. $b^2 - 24b = 0$

$\Rightarrow b(b - 24) = 0$

Then, $b = (0)$ or $a = (24)$

So, when $a = (-28)$, $a < b$ for $b = (0)$ and $a < b$ for $b = (24)$

And when $a = (28)$, $a > b$ for $b = (0)$ and $a > b$ for $b = (24)$

\therefore So, the relationship cannot be determined.

39. Answer: C)

I. $a = \sqrt{1225}$

$\Rightarrow a = \sqrt{(35 \times 35)}$



Ultra Practice Bundle PDF for All Bank Prelims Exams

$$\Rightarrow a = +35$$

$$\text{II. } b^2 = 1225$$

$$\Rightarrow b^2 = (35)^2$$

$$\Rightarrow b = \pm 35$$

So, when $a = +35$, $a = b$ for $a = +35$ and $a > b$ for $a = -35$

\therefore We can observe that $a \geq b$.

40. Answer: E)

$$\text{I. } a^2 - 64 = 0$$

$$\text{Use: } (a^2 - b^2) = (a - b)(a + b)$$

$$\Rightarrow (a + 8)(a - 8) = 0$$

Then, $a = 8$ or $a = -8$

$$\text{II. } 9b^2 - 729 = 0$$

$$\Rightarrow 9(b^2 - 81) = 0$$

$$\text{Use: } (a^2 - b^2) = (a - b)(a + b)$$

$$\Rightarrow (b^2 - 81) = 0$$

$$\Rightarrow (b + 9)(b - 9) = 0$$

Then, $b = 9$ or $b = -9$

So, when $a = -8$, $a > b$ for $b = -9$ and $a < b$ for $b = 9$

And when $a = 8$, $a > b$ for $b = -9$ and $a < b$ for $b = 9$

\therefore So, the relationship cannot be determined.

41. Answer: E)

From equation I:

$$x^2 - 22x + 120 = (x - 10)(x - 12) = 0$$

$$\Rightarrow x = 10, 12$$

From equation II:

$$y^2 - 3y - 130 = (y - 13)(y + 10) = 0$$

$$\Rightarrow y = 13, -10$$

	$X = 10$	$X = 12$
$Y = 13$	$x < y$	$x < y$
$Y = -10$	$x > y$	$x > y$

So, relationship cannot be established between x and y

42. Answer: A)

$$\text{I) } x^2 - 5x + 6 = 0$$

$$\Rightarrow (x - 2)(x - 3) = 0$$

$$\Rightarrow x = 2, 3$$

$$\text{II) } y^4 - 5y^2 + 6 = 0$$

$$\text{Let } y^2 = t$$

$$\Rightarrow y = \sqrt{t}$$

$$\Rightarrow t^2 - 5t + 6 = 0$$

$$\Rightarrow (t - 2)(t - 3) = 0$$

$$\Rightarrow t = 2, 3$$

$$\Rightarrow y = \pm\sqrt{2}, \pm\sqrt{3}$$

$$\Rightarrow \text{For } x = 2 \text{ and } y = \pm\sqrt{2}$$

$$\Rightarrow x > y$$

$$\Rightarrow \text{For } x = 3 \text{ and } y = \pm\sqrt{2}$$

$$\Rightarrow x > y$$

$$\Rightarrow \text{For } x = 2 \text{ and } y = \pm\sqrt{3}$$

$$\Rightarrow x > y$$

$$\Rightarrow \text{For } x = 2 \text{ and } y = \pm\sqrt{3}$$

$$\Rightarrow x > y$$

$$\therefore x > y$$

43. Answer: C)

$$\text{I. } 4x^2 - 9x + 2 = 0$$



Ultra Practice Bundle PDF for All Bank Prelims Exams

$$\Rightarrow 4x^2 - 8x - x + 2 = 0$$

$$\Rightarrow 4x(x - 2) - 1(x - 2) = 0$$

$$\Rightarrow (x - 2)(4x - 1) = 0$$

Then, $x = + 2$ or $x = + \frac{1}{4}$

$$\text{II. } y^2 + 29y - 62 = 0$$

$$\Rightarrow y^2 + 31y - 2y - 62 = 0$$

$$\Rightarrow y(y + 31) - 2(y + 31) = 0$$

$$\Rightarrow (y + 31)(y - 2) = 0$$

Then, $y = - 31$ or $y = + 2$

So, when $x = + 2$, $x > y$ for $y = - 31$ and $x = y$ for $y = + 2$

And when $x = + \frac{1}{4}$, $x > y$ for $y = - 31$ and $x < y$ for $y = + 2$

\therefore So, we can observe that no clear relationship cannot be determined between x and y .

44. Answer: C)

From I:

$$x^2 - 17x + 60 = 0$$

$$x^2 - 12x - 5x + 60 = 0$$

$$x(x - 12) - 5(x - 12) = 0$$

$$(x - 12)(x - 5) = 0$$

$$x = 12, 5$$

From II:

$$y^2 - 23y + 120 = 0$$

$$y^2 - 15y - 8y + 120 = 0$$

$$y(y - 15) - 8(y - 15) = 0$$

$$(y - 15)(y - 8) = 0$$

$$y = 8, 15$$

X	Relation	Y
12	>	8
12	<	15
5	<	8
5	<	15

So, the relationship cannot be established between x and y .

45. Answer: C)

From I:

$$x^2 - x - 56 = 0$$

$$x^2 + 7x - 8x - 56 = 0$$

$$x(x + 7) - 8(x + 7) = 0$$

$$(x + 7)(x - 8) = 0$$

$$x = -7, 8$$

From II:

$$y^2 - 15y + 56 = 0$$

$$y^2 - 7y - 8y + 56 = 0$$

$$y(y - 7) - 8(y - 7) = 0$$

$$(y - 8)(y - 7) = 0$$

$$y = 8, 7$$

X	Relation	Y
-7	<	8
-7	<	7
8	=	8
8	>	7

So, the relationship cannot be established between x and y .

46. Answer: E)

From I:

$$x^2 - 88 = 273$$

$$x^2 = 361$$



Ultra Practice Bundle PDF for All Bank Prelims Exams

$$x = 19, -19$$

From II:

$$y = \sqrt{361}$$

$$y = 19$$

X	Relation	Y
19	=	19
-19	<	19

So, $x \leq y$

47. Answer: A)

From I:

$$x^2 - 23x + 132 = 0$$

$$x^2 - 12x - 11x + 132 = 0$$

$$x(x - 12) - 11(x - 12) = 0$$

$$(x - 12)(x - 11) = 0$$

$$x = 12, 11$$

From II:

$$y^2 - 20y + 100 = 0$$

$$y^2 - 10y - 10y + 100 = 0$$

$$y(y - 10) - 10(y - 10) = 0$$

$$(y - 10)(y - 10) = 0$$

$$y = 10, 10$$

X	Relation	Y
12	>	10
11	>	10

So, $x > y$

48. Answer: B)

From I:

$$x^2 + 3x - 88 = 0$$

$$x^2 + 11x - 8x - 88 = 0$$

$$x(x + 11) - 8(x + 11) = 0$$

$$(x + 11)(x - 8) = 0$$

$$x = -11, 8$$

From II:

$$y^2 - 33y + 242 = 0$$

$$y^2 - 22y - 11y + 242 = 0$$

$$y(y - 22) - 11(y - 22) = 0$$

$$(y - 11)(y - 22) = 0$$

$$y = 11, 22$$

X	Relation	y
-11	<	22
-11	<	11
8	<	22
8	<	11

So, $x < y$

49. Answer: C)

From equation I:

$$x^2 + 5x + 6 = (x + 3)(x + 2) = 0$$

$$\Rightarrow x = -3, -2$$

From equation II:

$$y^2 - 19y - 42 = (y - 21)(y + 2) = 0$$

$$\Rightarrow y = 21, -2$$

	X = -3	X = -2
Y = 21	x < y	x < y
Y = -2	x < y	x = y

So, $x \leq y$

50. Answer: D)

From equation I:

Ultra Practice Bundle PDF for All Bank Prelims Exams

$$x^2 + 18x + 80 = (x + 8)(x + 10) = 0$$

$$\Rightarrow x = -8, -10$$

From equation II:

$$y^2 + 29y + 190 = (y + 10)(y + 19) = 0$$

$$\Rightarrow y = -10, -19$$

	X = -8	X = -10
Y = -10	x > y	x = y
Y = -19	x > y	x > y

So, $x \geq y$

9. Pie Chart DI

Directions (1 – 5): Study the following information and answer the following questions:

The following Pie Chart Shows distribution of Branches of a bank named Bank of Jaipur in 6 different states in India. Bank of Jaipur does not have branches other than below mentioned states.

Bank of Jaipur - Branches Distribution

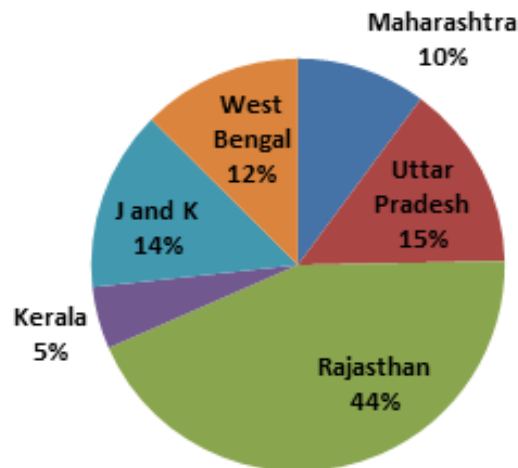

1. If West Bengal has total 144 branches of Bank of Jaipur then the number of branches in state Kerala and Uttar Pradesh together is?

- a) 180
- b) 240
- c) 120
- d) 480
- e) None of the above

2. West Bengal and Rajasthan together constitute how much percent of branches of Bank of Jaipur?

- a) 54%

Ultra Practice Bundle PDF for All Bank Prelims Exams

- b) 78%
- c) 44%
- d) 56%
- e) None of the above

3. What is the ratio of number of branches of state Maharashtra has to the number of branches state J and K has?

- a) 5 : 7
- b) 7 : 5
- c) 12 : 5
- d) 5 : 12
- e) None of the above

4. If Bank of Jaipur has total 1220 branches operational all over India. By what percent they have to increase the number of branches in Kerala to have 90 operational branches in Kerala?

- a) 32.33%
- b) 41.23%
- c) 47.54%
- d) 60%
- e) Can't be determined

5. Bank of Jaipur branches in Rajasthan are how much percent more or less than number of branches in Uttar Pradesh state?

- a) 100%
- b) 211.33%
- c) 150%
- d) 255.77%
- e) None of these

Directions (6 – 10): Answer the questions based on the information given below.

Given Pie chart shows the distribution of exports of the state TamilNadu in the year 2019 to different countries. The given figures are in Rs. (in Lacs).

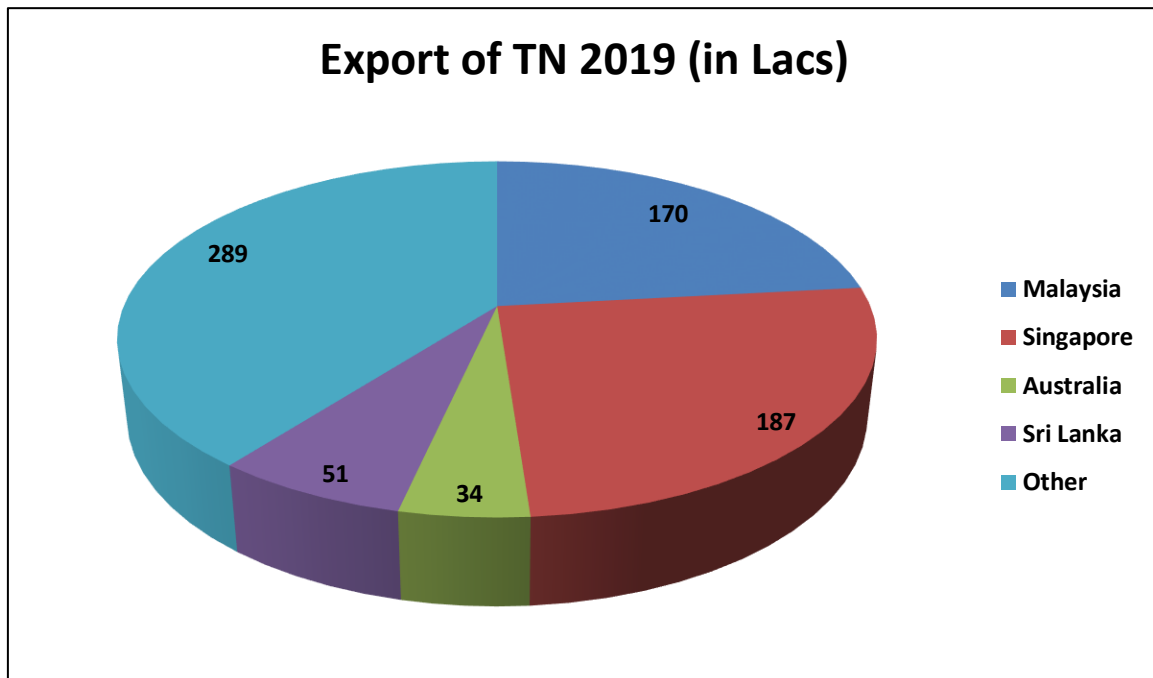

6. Export to Malaysia constitutes how much percent out of total exports of state TamilNadu?

- a) 25.23%
- b) 23.25%
- c) 26.25%
- d) 25.26%
- e) None of the above

7. If half the exports out of exports to other countries went to Europe, calculate the difference between exports went to Europe and Malaysia?

- a) 31.5 Lacs
- b) 11 Lacs
- c) 25.5 Lacs
- d) 22 Lacs
- e) None of the above

8. What is the ratio of total exports went to Singapore and Australia together to the total exports went to Sri Lanka and Malaysia together?

- a) 1 : 1
- b) 2 : 1

Ultra Practice Bundle PDF for All Bank Prelims Exams

- c) 1 : 2
- d) Cannot be determined.
- e) None of the above

9. If the ratio of Import to export for TN state is 19 : 17. It is also known that one-third of Imports were from Malaysia. Then the imports from Malaysia are how much percent more than the exports of Malaysia in 2019.

- a) 30.38%
- b) 37.57%
- c) 54.19%
- d) 60.19%
- e) None of these

10. Find the exports made to Sri Lanka in 2020 if the exports made to Sri Lanka are decreased by one-third in 2020 as compared to 2019.

- a) 51
- b) 34
- c) 17
- d) 68
- e) None of the above

Directions (11 – 15): Answer the questions based on the information.

Pie chart given below shows the runs scored by 5 batsmen of Indian cricket team in a tournament. Total 5 matches were played in tournament and each player has played different number of matches.

Ultra Practice Bundle PDF for All Bank Prelims Exams

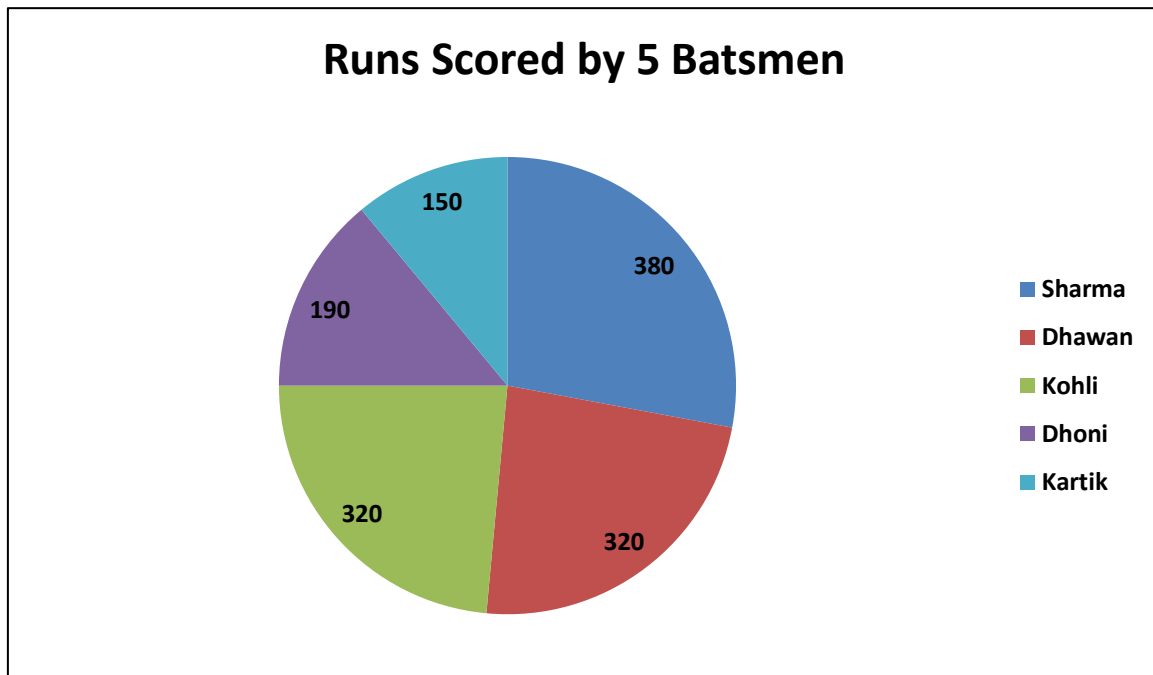

11. If Sharma has played all 5 matches of the series, then calculate the batting average in the tournament?

- a) 95
- b) 67
- c) 60
- d) 76
- e) None of the above

12. What is ratio of total runs made by openers in the tournament to the total runs made by other 3 batsmen?

Note: Sharma and Dhawan used to open every match in tournament?

- a) 35 : 33
- b) 72 : 52
- c) 21 : 19
- d) 11 : 19
- e) None of these

13. How many runs will Dhawan have to score in next match if it is played to match Sharma's average if Sharma is not playing next match and both have not missed any match till date in this tournament?

- a) 122
- b) 125

Ultra Practice Bundle PDF for All Bank Prelims Exams

- c) 136
- d) Cannot be determined.
- e) None of these

14. Runs scored by Kartik are how much percent more / less by total runs scored by Dhoni in the tournament?

- a) 22.02%
- b) 21.05%
- c) 27.5%
- d) 75.75%
- e) None of these

15. Among all batsmen, everyone played all 5 matches then who among them has got 2nd best batting average in the tournament?

- a) Sharma
- b) Dhawan
- c) Kohli
- d) Both Kohli and Dhawan
- e) Can't be determined

Directions (16-20): Answer the questions based on the information given below.

Pie chart given below shows the % of marks obtained in 5 different subjects by a student in the board exams of the year 2020.

Note: The Total marks for English, History, Geography, polity and Maths were 100, 50, 50, 100 and 150 respectively.

Ultra Practice Bundle PDF for All Bank Prelims Exams

Percentage of marks obtained in each subject

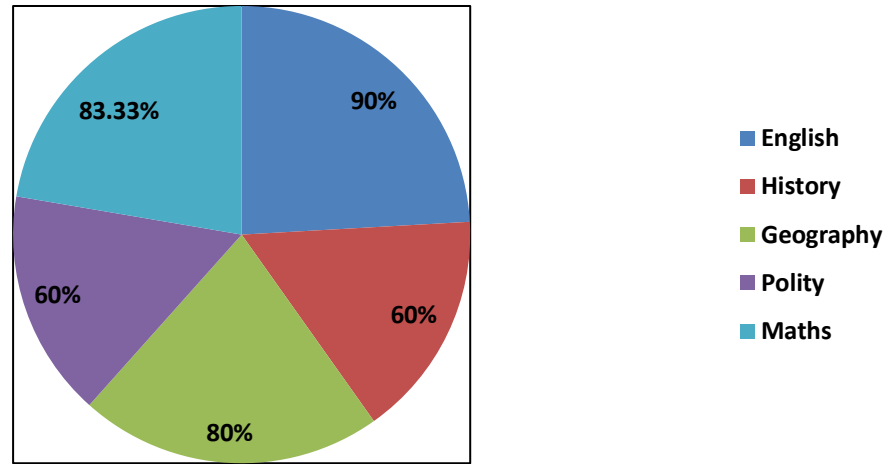

16. What is the overall percentage obtained by the student in the board exams?

- a) 46.67%
- b) 56.67%
- c) 66.67%
- d) 76.67%
- e) None of the above

17. What are the total marks obtained by the student in Maths and History?

- a) 195
- b) 150
- c) 155
- d) 160
- e) None of these

18. Marks obtained in the subject geography are how much percent more / less than the marks obtained in the subject History?

- a) 77%
- b) 66.67%

Ultra Practice Bundle PDF for All Bank Prelims Exams

- c) 50%
- d) 33.33%
- e) Can't be determined

19. If there is another student who has same total percentage as total percentage of above mentioned student, What are the marks obtained by another student in the Maths subject?

- a) 37.50%
- b) 22.22%
- c) 33.33%
- d) 44.44%
- e) Cannot be determined.

20. If the student gets 20 marks more in history and polity subject, then which subject will have the best percentage obtained?

- a) History
- b) Polity
- c) Science
- d) Geography
- e) None of the above

Directions (21 – 25): Study the information carefully and answer the question asked below.

Pie chart given below shows the different types A, B, C, D and E of grains (in Kg.) sold by a shopkeeper in the month of July.

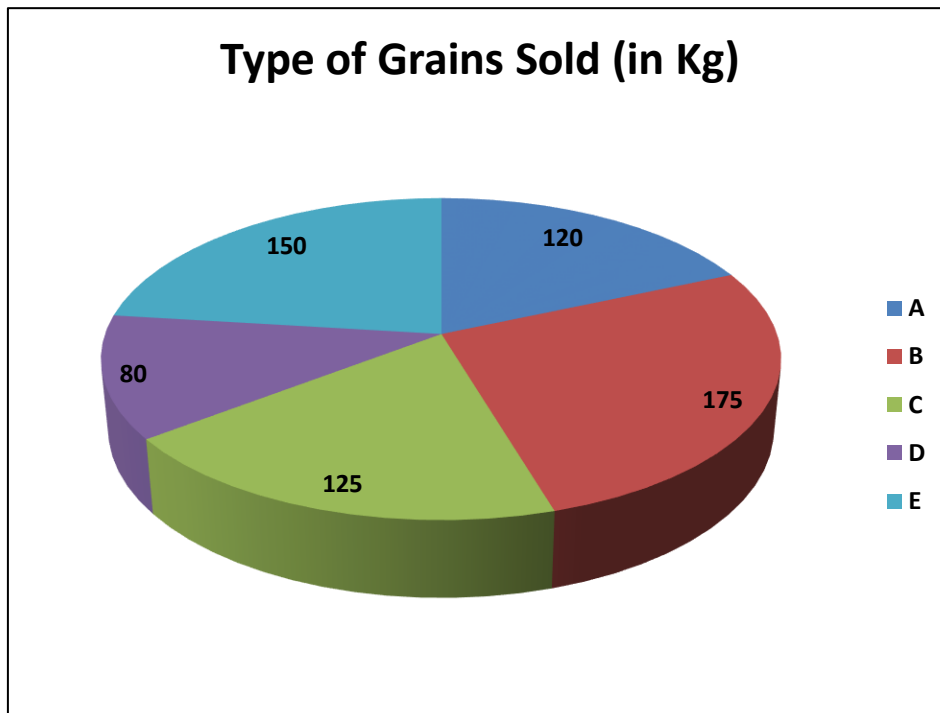

21. In the month of August if the shopkeeper sells 25% of grains of Type A only. What is the sell in Kg. of type A in month of August if his total sell has increased by 20% than July?

- a) 195
- b) 180
- c) 8
- d) 105
- e) 120

22. By what percent the sell of grains of type E and D together is more or less than sell of type C and B together?

- a) 35.35%
- b) 23.33%
- c) 45.45%
- d) 49.52%
- e) None of the above

23. If the ratio of the sale of gains in the month of June and July is 12 : 15. Then what is total sale of grains in Kg. in the month of June?

- a) 252

Ultra Practice Bundle PDF for All Bank Prelims Exams

- b) 562
- c) 550
- d) 520
- e) None of these

24. How many types of grains have above average sale in the month of August?

- a) 1
- b) 3
- c) 2
- d) 4
- e) None of these

25. Type A, B and C gave how much percent of sale out of total sale made by the shopkeeper?

- a) 64.61%
- b) 61.64%
- c) 23.33%
- d) 66.67%
- e) 33.34%

Directions (26 – 30): Read the following information carefully and answer the following questions carefully.

Pie chart given below shows average marks obtained by students from 5 different schools P, Q, R, S, T in National level exam. The exam has maximum marks 200.

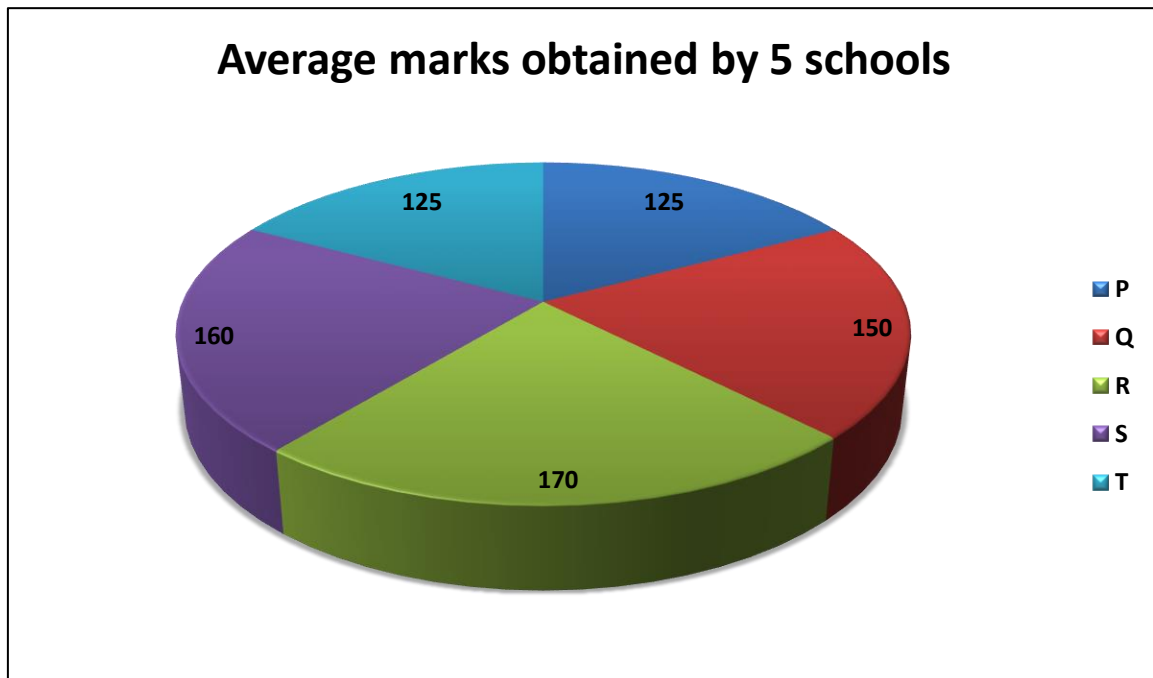

26. The total marks obtained by School P are how much more / less than the total marks obtained by School Q if both schools have 50 students each?

- a) 1250
- b) 1550
- c) 1850
- d) 1750
- e) 1650

27. What is average of marks obtained by all schools together if it is known that all schools have 70 students each participating in the exam?

- a) 185
- b) 146
- c) 164
- d) 175
- e) None of these

28. What is the ratio of average marks of school Q to the average marks of school R as per the given pie chart?

- a) 17 : 15
- b) 7 : 8

Ultra Practice Bundle PDF for All Bank Prelims Exams

c) 15 : 17

d) 8 : 7

e) None of the above

29. If the average marks obtained by school P and Q together is 140. It is known that 50 students from school P took participation in the competition, then find the number of students from school Q who took participation?

a) 25

b) 50

c) Cannot be determined

d) 75

e) None of the above.

30. By what percent average marks obtained by school R and school S together are more or less than the total marks obtained by school Q and T together?

a) 20%

b) 25%

c) 72%

d) 23%

e) 69%

Directions (31 – 35): Read the following information carefully and answer the following questions given below.

Following Pie chart shows the number of subscribers of different YouTube channels have at the end of July 2020.

Ultra Practice Bundle PDF for All Bank Prelims Exams

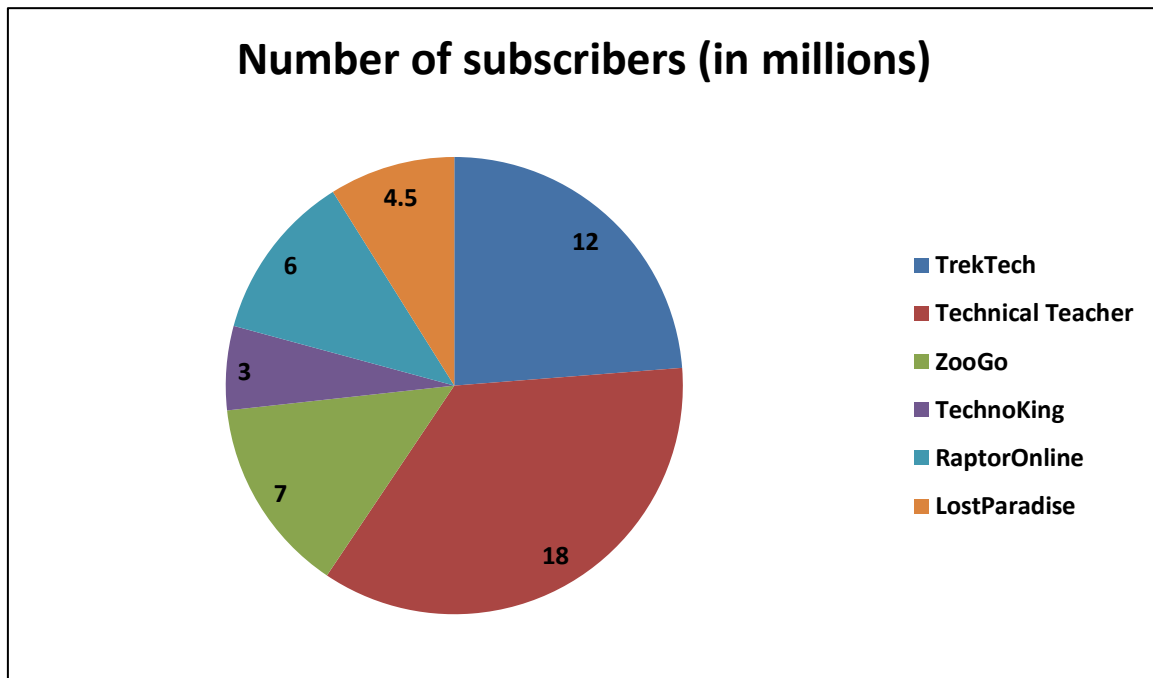

31. By what percent the number of subscribers of Technical Teacher are more than the number of subscribers of TrekTech?

- a) 20%
- b) 30%
- c) 50%
- d) 70%
- e) None of these

32. What is the average number of subscribers (in millions) for the above mentioned 6 YouTubers together?

- a) 6.21
- b) 8.21
- c) 7.29
- d) 8.33
- e) None of these

33. If the number of subscribers of TrekTech are increased to 15 million at the end of August month then what is the growth in percent compared to the end of July?

- a) 40%
- b) 30%

Ultra Practice Bundle PDF for All Bank Prelims Exams

- c) 20 %
- d) 25%
- e) None of these

34. Average view time of a subscriber of ZooGo is 7 minutes 15 seconds and average view time of Raptoronline is 8 minutes 45 seconds per subscriber. What is the total view time for ZooGo and Raptoronline in the month of july?

- a) 102.25 million minutes
- b) 218. 78 million minutes
- c) 103.25 million minutes
- d) 35.7 million minutes
- e) None of these

35. What is the ratio of total number of subscribers for ZooGo and TechnoKing together to the number of subscribers of TrekTech?

- a) 11 : 12
- b) 5 : 6
- c) 1 : 3
- d) 6 : 5
- e) None of the above

Directions (36 – 40): Read the data given below and answer the following questions.

Top Leading companies sold following numbers (in thousands) of different models of Smartphones in 2019. Answer the following questions based on the given data. Data is given for models A, B, C, D and E.

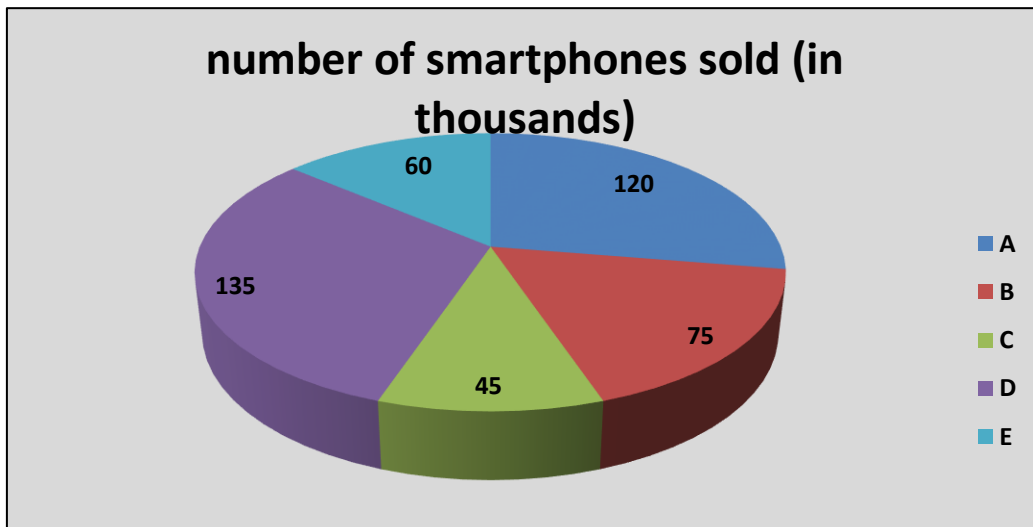

36. What is the ratio of number of smartphones sold of model C and D together to the number of smartphones sold for the models A and E together?

- a) 1 : 1
- b) 5 : 6
- c) 2 : 3
- d) 1 : 2
- e) None of these

37. Find the difference in thousands between the numbers of highest number of smartphones sold to the lowest number of smartphones sold for any model?

- a) 100
- b) 90
- c) 200
- d) 95
- e) 125

38. How many types of the models have its sale above average for the year 2019?

- a) 3
- b) 1
- c) 5
- d) 2

Ultra Practice Bundle PDF for All Bank Prelims Exams

e) None of the above

39. If the sale of total number of smartphones increases by 17% in 2020. What is the number of units in thousands sold of model C in 2020?

- a) 340
- b) 220
- c) 250
- d) Cannot be determined
- e) None of these

40. By how much percent the sale of model B is more than model E?

- a) 23%
- b) 25%
- c) 45%
- d) 50%
- e) 37%

Direction (41-45): Read the data given below and answer the following questions.

The Pie below shows the distribution of the percentage of tigers in wildlife sanctuaries in India. Data is given for 5 different wildlife sanctuaries in India of the year 2019. Total number of tigers in these 5 sanctuaries is 1500.

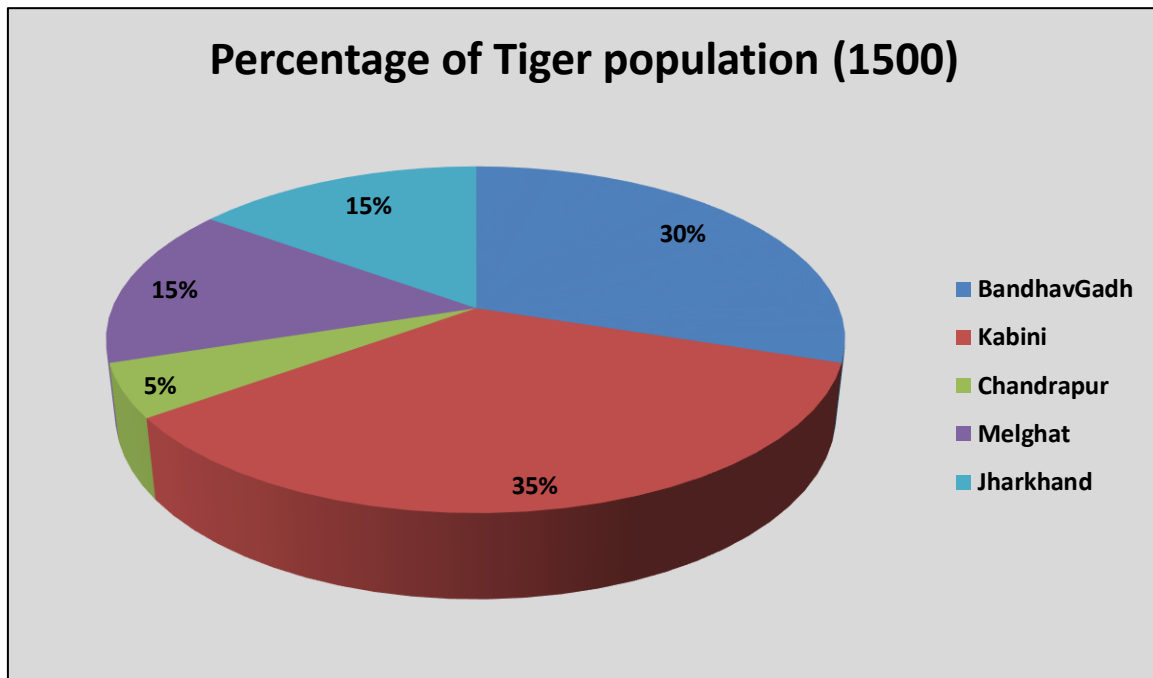

41. Find the % increase or decrease in the total number of tigers in sanctuary E in 2020 as compare to the previous year?

- a) 1.1%
- b) 2.25%
- c) 1.28%
- d) Cannot be determined
- e) None of these

42. The average of the number of tigers in all the sanctuaries together is for the year 2019?

- a) 445
- b) 500
- c) 300
- d) 405
- e) None of these

43. What is the difference between number of tigers in Kabini and Melghat for the year 2019?

- a) 300
- b) 225

Ultra Practice Bundle PDF for All Bank Prelims Exams

c) 160

d) 120

e) 390

44. What is the ratio of the number of tigers from Jharkhand to the difference between number of tigers from Melghat and Chandrapur?

a) 2 : 5

b) 3 : 2

c) 3 : 5

d) 4 : 5

e) None of these

45. If the number of tigers in BandhavGadh increased by 10% and Melghat increased by 32% in the year 2020. Then what is the respective ratio of number of tiger since the year 2020?

a) 6 : 7

b) 1 : 7

c) 5 : 3

d) 1 : 4

e) None of these

Directions (46 – 50): Read the data given below and answer the following questions.

The Pie Chart shows that number of male athletes from each country for the Diamond league sports championship 2019.

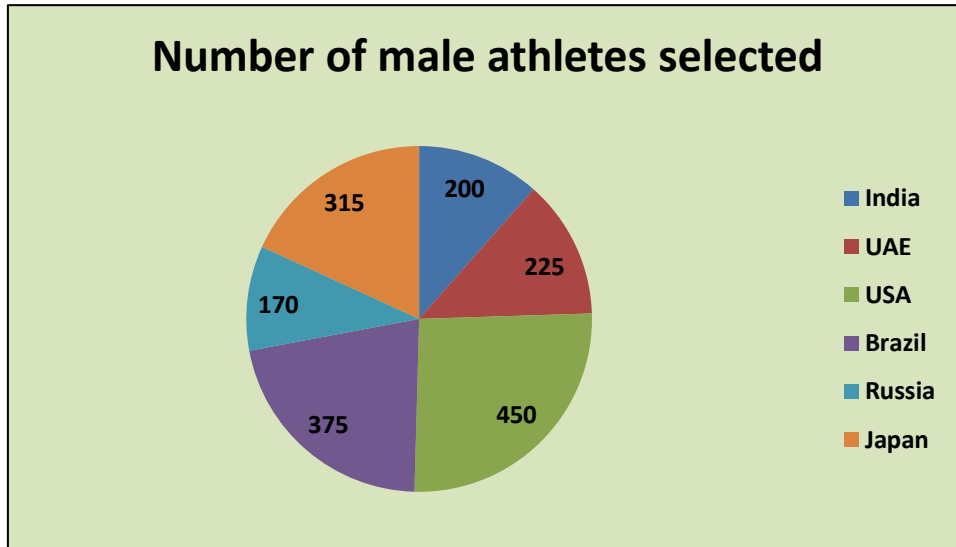

46. What is the ratio of male athletes selected to the female athletes selected from UAE if 275 female athletes were selected from UAE?

- a) 9 : 11
- b) 15 : 9
- c) 11 : 9
- d) 8 : 7
- e) 31 : 19

47. Find the average number of male athletes selected from India, USA and Brazil together?

- a) 257.5
- b) 341.67
- c) 111.75
- d) 433.07
- e) 107.12

48. If the ratio of male athletes to female athletes from USA is 3 : 2. And the same ratio for India is 1 : 1. What is the difference between number of female athletes from India and USA?

- a) 38
- b) 25
- c) 100
- d) 50

Ultra Practice Bundle PDF for All Bank Prelims Exams

e) 80

49. By what percent male athletes from Japan are less than the male athletes from Brazil?

a) 16%

b) 26%

c) 46%

d) 15%

e) 25%

50. What is the percentage of male athletes selected for country Brazil out of total male athletes selected?

a) 14.42%

b) 21.61%

c) 27.42%

d) 19.66%

e) 21.15%

Solutions and Detailed Explanations

1-5:

1. Answer: B)

West Bengal has total 144 branches which is 12% of total branches.

Kerala and UP has combined $15\% + 5\% = 20\%$ branches.

Thus, $144 / x = 12 / 20$

$X = 240$ branches Kerala and UP together.

2. Answer: D)

West Bengal and RJ together constitute $12\% + 44\% = 56\%$ of branches. It is clearly visible from the pie chart.

3. Answer: A)

Let total number of branches be $100x$.

Branches in MH = 10% of $100x = 10x$

Branches in J & K = 14% of $100x = 14x$

Ultra Practice Bundle PDF for All Bank Prelims Exams

$$\text{Ratio} = 10x : 14x = 5 : 7$$

4. Answer: C)

Currently there are 1220 total branches in India.

$$\text{Branches in Kerala} = 5\% \text{ of } 1220 = 61$$

Now to make number of branches 90

$$\text{Increase in number of branches} = 90 - 61 = 29$$

$$\text{Percentage increase} = 29 / 61 * 100 = 47.54\%$$

5. Answer: E)

Let total number of branches be $100x$.

$$\text{Branches in RJ} = 44\% \text{ of } 100x = 44x$$

$$\text{Branches in UP} = 15\% \text{ of } 100x = 15x$$

$$\text{Percentage} = 44x - 15x = 29x$$

$$= 29x / 15x * 100 = 193.33\% \text{ more}$$

6-10.

6. Answer: B)

$$\text{Total exports for the state of TN} = 170 + 187 + 34 + 51 + 289 = 731 \text{ Lacs}$$

$$\text{Exports to Malaysia} = 170 \text{ Lacs}$$

$$\text{Percentage} = 170 / 731 * 100 = 23.25\%$$

7. Answer: C)

$$\text{Export to other countries} = 289 \text{ Lacs}$$

$$\text{Half went to Europe} = 289 / 2$$

$$\text{Difference between exports to Europe and Malaysia} = 170 - 289/2 = 25.5 \text{ Lacs}$$

8. Answer: A)

$$\text{Exports went to Australia and Singapore together} = 187 + 34 = 221 \text{ Lacs}$$

$$\text{total exports went to Sri Lanka and Malaysia together} = 51 + 170 = 221 \text{ Lacs}$$

Ultra Practice Bundle PDF for All Bank Prelims Exams

Required ratio = $221 : 221 = 1 : 1$

9. Answer: D)

ratio of Import to export for TN state is $19 : 17$.

Total exports to TN = 731 Lacs

Imports for TN = $19 / 17 = x / 731$

$X = 817$ Lacs

One third imports came from Malaysia = $1 / 3 * 817 = 272.33$

Percentage more = $272.33 - 170 / 170 * 100 = 60.19\%$

10. Answer: B)

Exports made to Sri Lanka are decreased by one-third in 2020 as compared to 2019.

New exports to Sri Lanka = $2/3$ of exports made in 2019

= $2/3 * 51 = 34$ Lacs

11-15.

11. Answer: D)

Sharma has played all 5 matches in the series.

Average = Total runs / number of matches = $380/5 = 76$

12. Answer: A)

ratio of total runs made by openers in the tournament to the total runs made by other 3 batsmen

Openers = Sharma and Dhawan

Runs scored by them = $380 + 320 = 700$

Runs scored by other 3 = $320 + 190 + 150 = 660$

Ratio = $700 : 660 = 35 : 33$

13. Answer: C)

Sharma's average = $380 / 5 = 76$

Dhawan's current average = $320 / 5 = 64$

Ultra Practice Bundle PDF for All Bank Prelims Exams

Runs to be scored in next match to equal the average = $(64 \times 5 + x) / 6 = 76$

$$X = 136$$

14. Answer: B)

Runs scored by Kartik are how much percent more / less by total runs scored by Dhoni

$$= (190 - 150) / 190 = 21.05\% \text{ less}$$

15. Answer: D)

If everybody plays 5 matches, then 2nd best average

That figure will 2nd best total number of runs since number of matches played will be same for everyone.

Dhawan and Kohli will be the answer as both have 320 runs.

16-20. Common Explanation

Marks obtained in English = $100 * 90\% = 90$

Marks obtained in history = $50 * 60\% = 30$

Marks obtained in geography = $50 * 80\% = 40$

Marks obtained in polity = $100 * 60\% = 60$

Marks obtained in Maths = $150 * 83.33\% = 125$

16. Answer: D)

overall percentage obtained by the student in the board exams =

Total marks obtained / Total marks * 100 =

$$= (90 + 30 + 40 + 60 + 125) / (100 + 50 + 50 + 100 + 150) * 100$$

$$= 345 / 450 = 76.67\%$$

17. Answer: C)

the total marks obtained by the student in Maths and History = $125 + 30 = 155$

18. Answer: D)

Marks obtained in the subject geography = 40

marks obtained in the subject History = 30

Ultra Practice Bundle PDF for All Bank Prelims Exams

Percentage more = $(40 - 30) / 30 * 100 = 33.33\%$

19. Answer: E)

This figure cannot be determined since we only know the overall percentage which is not enough to calculate marks obtained in Maths.

20. Answer: A)

If students get 20 marks more in history = $30 + 20 = 50$

Percentage = $50/50 * 100 = 100\%$

If students gets 20 more marks in polity = $60 + 20 = 80$

Percentage = $80/ 100 * 100 = 80\%$

History will have best percentage obtained.

21-25. Common Explanation

Total sale in July = $120+175+125+80+150 = 650$

21. Answer: A)

In august total sell has increased by 20% than July.

Total sale in July = 650

Sale in august = $120 / 100 * 650 = 780$

In the month of August if the shopkeeper sells 25% of grains of Type A only.

= $780 * 25 / 100 = 195$ kg.

22. Answer: B)

the sell of grains of type E and D = $150 + 80 = 230$ kg

sell of type C and B together = $175 + 125 = 300$ kg

Percentage less = $300 - 230 / 300 * 100 = 23.33\%$

23. Answer: D)

ratio of the sale of gains in the month of June and July is 12 : 15

Sale of grains in the month of June = $12 / 15 = x / 650 = 520$

24. Answer: C)

Ultra Practice Bundle PDF for All Bank Prelims Exams

Average sale in the month of July = $650 / 5 = 130$

Types of grains having above average sale = 2 (Type B and E)

25. Answer: A)

Total Sale by Type A,B,C = $120 + 175 + 125 = 420$ kg

Total sale = 650 kg

Percentage = $420 / 650 * 100 = 64.61\%$

26-30.

26. Answer: A)

total marks obtained by School P =

= number of students * average marks

= $125 * 50 = 6250$

total marks obtained by School Q

= number of students * average marks

= $150 * 50 = 7500$

Difference of Total marks = $7500 - 6250 = 1250$

27. Answer: B)

Average of marks obtained by all schools together if it is known that all schools have 70 students each.

= Total marks obtained / total number of students

= $(125 + 150 + 170 + 160 + 125) * 70 / 350$

= 146

28. Answer: C)

Average marks of school Q to the average marks of school R

= 150 : 170

= 15 : 17

29. Answer: D)

Ultra Practice Bundle PDF for All Bank Prelims Exams

Average marks obtained by school P and Q together is 140.

50 students from school P took participation in the competition.

Using the formula for average = Total marks by p and Q / total students of P and Q = Average

Let x students took participation from Q

$$(125 * 50 + 150 * x) / (50 + x) = 140$$

$$X = 75$$

30. Answer: A)

average marks obtained by school R and school S together = $170 + 160 = 330$

total marks obtained by school Q and T together = $150 + 125 = 275$

$$\text{Percentage} = 330 - 275 / 275 * 100 = 20\%$$

31-35.

31. Answer: C)

the number subscribers of Technical Teacher = 18 mil

number of subscribers of TrekTech = 12 mil

$$\text{Percentage} = (18 - 12) / 12 * 100 = 50\%$$

32. Answer: E)

Average number of subscribers = $12 + 18 + 7 + 3 + 6 + 4.5 / 6 = 50.5 / 6 = 8.41$ millions

33. Answer: D)

subscribers of TrekTech are increased to 15 million.

July subscribers = 12 millions

$$\text{Percentage increase} = 15 - 12 / 12 * 100 = 25\%$$

34. Answer: C)

Average view time of subscribers of ZooGo is 7 minutes 15 seconds = $7 * 60 + 15 = 435$ sec

average view time of Raptoronline is 8 minutes 45 seconds = $8 * 60 + 45 = 480 + 45 = 525$ sec

Total view time for ZooGo = $435 * 7$ million = 3045 million sec

Ultra Practice Bundle PDF for All Bank Prelims Exams

$$= 3045 / 60 = 50.75 \text{ million minutes}$$

$$\text{Total view time for RaptorOnline} = 525 * 6 \text{ million} = 3150 \text{ million sec}$$

$$= 3150 / 60 = 52.5 \text{ million minutes}$$

$$\text{Total view time} = 103.25 \text{ million min}$$

35. Answer: B)

$$\text{Total number of subscribers for ZooGo and TechnoKing together} = 7 + 3 = 10 \text{ million}$$

$$\text{Number of subscribers of TrekTech} = 12 \text{ million}$$

$$\text{Ratio} = 10 : 12 = 5 : 6$$

36-40.

36. Answer: A)

$$\text{Number of smartphones sold of model C and D together} = 45 + 135 = 180 \text{ thousands}$$

$$\text{Number of smartphones sold for the models A and E together} = 180 \text{ thousands}$$

$$\text{Ratio} = 180 : 180 = 1 : 1$$

37. Answer: B)

$$\text{Numbers of highest number of smartphones sold} = 135 \text{ thousands for Model D}$$

$$\text{Lowest number of smartphones sold for any model} = 45 \text{ thousands for Model C}$$

$$\text{Required difference} = 135 - 45 = 90 \text{ thousands}$$

38. Answer: D)

$$\text{Average sale for the year 2019} = 120 + 75 + 45 + 135 + 60 = 435 / 5 = 87$$

$$\text{Number of models having above average sale} = \text{Type A, Type D} = 2$$

39. Answer: D)

$$\text{Sale of smartphones in 2019} = 435$$

$$\text{sale of total number of smartphones increases by 17\% in 2020} = 435 * 117 / 100 = 508.95$$

The number of units in thousands sold of model C in 2020 cannot be determined because we don't know the percentage of type C sold out of total number of smartphones sold.

40. Answer: B)

$$\text{sale of model B} = 75000$$

Ultra Practice Bundle PDF for All Bank Prelims Exams

sale of model E = 60000

Percentage more = $(75 - 60) / 60 * 100 = 25\%$

41-45. Common Explanation:

Number of tigers in BandhavGadh = $1500 * 30 / 100 = 450$

Number of tigers in Kabini = $1500 * 35 / 100 = 525$

Number of tigers in Chandrapur = $1500 * 5 / 100 = 75$

Number of tigers in Melghat = $1500 * 15 / 100 = 225$

Number of tigers in Jharkhand = $1500 * 15 / 100 = 225$

41. Answer: D)

This cannot be determined since we don't have data from year 2020.

42. Answer: C)

Average of the number of tigers in all the sanctuaries together is for the year 2019

= Total number of tiger / number of sanctuaries

= $1500 / 5 = 300$

43. Answer: A)

Number of tigers in Kabini = 525

Number of tigers in Melghat = 225

Required difference = 300

44. Answer: B)

Number of tigers from Jharkhand = 225

Difference between number of tigers from Melghat and Chandrapur = $225 - 75 = 150$

Required ratio = $225 : 150 = 3 : 2$

45. Answer: C)

Number of tigers in BandhavGadh increased by 10%

= $450 * 110 / 100 = 495$

Ultra Practice Bundle PDF for All Bank Prelims Exams

Number of tigers in Melghat increased by 32%

$$= 225 * 132 / 100 = 297$$

$$\text{Required ratio} = 495 : 297 = 5 : 3$$

46-50. Common Explanation:

46. Answer: A)

Male athletes from UAE = 225

Female athletes from UAE = 275

$$\text{Required ratio} = 225 : 275 = 9 : 11$$

47. Answer: B)

Average number of male athletes selected from India, USA and Brazil together

$$= (200+450+375) / 3 = 1025 / 3 = 341.67$$

48. Answer: C)

Ratio of male athletes to female athletes from USA is 3 : 2

$$3 / 2 = 450 / x$$

$$x \text{ (say)} = 300$$

Ratio for India is 1 : 1

Female athletes from India = 200

Difference between number of female athletes from India and USA

$$= 300 - 200 = 100$$

49. Answer: A)

Male athletes from Japan = 315

Male athletes from Brazil = 375

$$\text{Required percentage} = (375-315) / 375 * 100 = 16\% \text{ less}$$

50. Answer: B)

Percentage of male athletes selected for country Brazil out of total male athletes selected



CWJ

Ultra Practice Bundle PDF for All Bank Prelims Exams

$$= 375 / (200+225+450+375+170+315) * 100$$

$$= 375 / 1735 * 100 = 21.61\%$$

Grand Bundle PDF Course 2021



Exams Covered:

SBI Clerk | SBI PO | IBPS RRB PO |
IBPS RRB Clerk | IBPS PO | IBPS Clerk



Separate PDF Course for All Major Bank **Pre + Mains** Exams

- Total No.of Ques : **40,000+**
- Questions in **English**
- Provides you **50 days Study Planner** for each exams
- **Covers all types** of questions in each topic
- Questions in **Exact Exam Level**
- All Our PDFs are **Downloadable**
- **100% Satisfaction Assured** & It's Worthy for your money

Grab it Now