

Dear Friends, this is the Special Paid Bundle PDF Course which was made because of the Hard work of Our Experts Team. This PDF Course consists of High-Standard Questions on Reasoning, Quants, English, Current Affairs Quiz, Static GK Quiz and Banking Awareness Quiz Exactly on Exam Level. Total 40,000 Questions and Course Duration is of 50 Days for each exam. If anyone got this PDF without purchasing it, kindly buy this PDF Officially using the link given below. This will encourage us to work harder to produce high quality content for you in upcoming days.

[Get Our Special Grand Bundle PDF Course for All Upcoming Bank Exams](#)

Grand Bundle PDF Course 2021

Exams Covered:
SBI Clerk | SBI PO | IBPS RRB PO |
IBPS RRB Clerk | IBPS PO | IBPS Clerk

Separate PDF Course for All Major **Bank Pre + Mains** Exams

- Total No. of Ques.: **40,000+**
- Question in Bilingual (**Eng & Hindi**)
- Answers With Detailed **Video Solution**
- Provides you **50 days Study Planner** for each exams
- **Covers all types** of questions in each topic
- Questions in **Exact Exam Level**
- All Our PDFs are **Downloadable**
- **100% Satisfaction Assured** & It's Worthy for your money

Reasoning Ability

Directions (1-5): Study the following information carefully and answer the below questions.

Seven persons joined the LMP organization in 2017. All have joined on different dates of either the same or different months. Each of them already has different working experiences.

Note: Total experience = Previous experience + Experience in the LMP organization.

At least four persons joined after L whose experience is an odd number. N joined two persons before the one has 14 years of experience. N and the one who has 14 years of experience joined either first or last in the company. The number of persons joined before N is the same as after the one who has 5 years of experience. The number of persons joined between N and L is the same as between Q and the one who has 15 years of experience. The one who has 14 years of experience joined immediately after the one who has 15 years of experience. P joined two persons after Q. P joined three persons after the one who joined immediately after 21st April. O joined before R who joined on 27th October and O joined after M. The one who has 8 years of experience joined three persons before the one who has 12 years of experience who joined on 30th July. N has experience which is an odd number. Q has twice the experience of O. The difference between the experience of O and N is the same as the difference between the experience of N and Q. The one whose experience is an even number joined on the date which is twice of his

experience and in the month which has an odd number of days. M does not join in January. One of the persons joined twelve days before R. One of them joined on 29th May. P does not join on 1st September.

Based on their working experience a foreign company LMP gives the project with certain conditions

The project is given to those people having total experience of (calculate their experience on the date 1st August 2020) at least 11 years and also has 3 years of experience in the same organization (in LMP).

1) Who among the following persons get the project?

- A. MQPR
- B. MQP
- C. OMR
- D. MQ
- E. MQR

2) If the company appointed the most experienced person (total experience) as CEO and the second-most experienced person is MD, who among the following will be MD of the company?

- A. R
- B. The one who joins on 15th October
- C. The one who joins immediately after L
- D. O
- E. None of these

3) The one who joined at the last in the LMP company, resigned from the job. Then who among the following person is resigned?

- A. N
- B. R
- C. The one who joined two persons after O
- D. The one who joined three persons after M
- E. L

4) How many persons joined between L and P?

- A. Five
- B. Four
- C. Three
- D. Two
- E. One

5) If N joins on the same date as O but the month unchanged, then after how many months N joins the company with respect to O?

- A. Five
- B. Six
- C. Four
- D. Three
- E. Seven

Directions (6-10): Study the following information carefully and answer the below questions

Twelve persons- A, B, C, D, E, F, G, H, I, J, K, and L are sitting in two parallel rows. Each row contains six persons facing each other. The persons who are sitting in row1 faces south and those who are sitting in row 2 facing north but not necessarily in the same order. They are having a different number of pens.

Note: The persons who are sitting in row1 are having an even number of pens and those who are sitting in row2, having an odd number of pens. No one has more than 30 pens. J sits opposite to the one who sits third to the left of the one who has 25 pens. J does not sit at the end of the row. Only two persons are sitting between B and the one who has half of the number of pens of J. B and J are not immediate neighbors but sits on the same row. B does not sit at the end of the row. The one who has 9 pens sits fourth to the left of the one who sits immediate left of I. Only three persons are sitting between L and I. The number of people sits to the left of the one who sits opposite to L is the same as persons to the left of G. The one who has 15 pens sits second to the left of G. K sits immediate right of C, neither of them sits at the end of the row. F has twice the pens of H. H has one pen less than D. D does not sit in the same row as E. F sits adjacent to neither J nor B. The number of people sits between D and I is the same as between F and H. The difference between the pens of C and I is the same as the difference between the pens of H and E. The difference between the pens of F and A is the same as between F and E. K has one pen less than the one who sits opposite to K. The sum of the pens of D and the one who sits second to the right of L is one less than the one who sits opposite to A. The sum of the pens of A and H is equal to the pens of B. The difference between the pens of E and K is the

same as between B and G. G does not have the prime number of pens.

Conditions:

They are playing the dice game. Two persons are rolling the dice at the same time.

I) If both of them are getting an even number, then their pens will be added to the pens of the person who sits opposite to them.

II) If both of them are getting an odd number, then their pens will be subtracted from the pens of the person who sits extreme right end of their respective rows.

III) If one person gets even and another one gets odd, then their pens will be thrice.

6) The person who sits immediate right of C and second to the left of J are rolling the dice, they get an odd number, then what is the difference between the pens with them (after applying the conditions)?

- A. 3
- B. 1
- C. 2
- D. 5
- E. 4

7) If the person who has 8 pens and the one who sits second to the left of C are rolling the dice and both are getting even numbers, then what is the product of unit digits of the pens with them?

- A. 20
- B. 15
- C. 25
- D. 28
- E. 18

8) What is the sum of the pens of the persons who sit at the end of both rows?

- A. 55
- B. 59
- C. 58
- D. 62
- E. 68

9) If the person who has 21 pens and the person who sits opposite to E are rolling the dice, one of them gets an odd number and another one gets half of the value of the pen that H has, then what is the sum of the pens with them?

- A. 128
- B. 114
- C. 122
- D. 118
- E. 132

10) How many persons are sitting between the one who sits immediate left of the one who has 25 pens and the one who sits opposite to F?

- A. Two
- B. No one
- C. Four
- D. Three
- E. One

Directions (11-15): Study the following information carefully and answer the below questions.

Eight people- P, Q, R, S, T, U, V, and W are sitting at the circular table facing the center but

not necessarily in the same order. They are of different ages but less than 60.

U sits third to the left of the one who sits immediate right of the one whose age is 38 years. Two persons are sitting between U and S. The one whose age is 27 sits second to the right of S. V's age is an odd number and sits adjacent to S. Q sits second to the right of the one who sits opposite to S. The one who sits opposite to Q sits immediate left of the one whose age is 22. T sits third to the left of W whose age is an even number. W is adjacent to neither U nor P. The age of R is an odd number. The one whose age is 18 sits opposite to T. The age difference between W and Q is the same as between W and S. The sum of the age of S and U is two years more than Q. R is younger than V whose age is not 49. The age difference between R and V is one year more than the age difference between U and T. One of the persons is 49 years old. W does not sit opposite to U.

11) What is the sum of the ages of W, V, and T?

- A. 125
- B. 130
- C. 122
- D. 112
- E. 137

12) How many persons are sitting between the one whose age is 18 and the one who sits immediate left of P when counted to the left of the person whose age is 18?

- A. One
- B. Two

- C. Three
- D. Four
- E. Five

13) Who among the following person sits second to the left of the one whose age is 27?

- A. The one who sits second to the right of U
- B. P
- C. T
- D. The one whose age is 38
- E. The one whose age is 18

14) If S is related to 49 and V is related to 42 in a certain way. Then who among the following is related to 22?

- A. The one who sits immediate left of S
- B. The one who sits opposite to Q
- C. U
- D. The one who sits third to the left of W
- E. The one whose age is 42

15) If S and Q interchanged their positions then Q and P did the same, who among the following person sits third to the left of the one whose age is 35?

- A. Q
- B. S
- C. P
- D. The one who sits immediate left of T
- E. The one who sits second to the right of V

Directions (16-18): Each of the questions below consists of a question and two statements numbered I and II given below it.

A#B means B is the father of A

A@B means A is the daughter of B

A&B means B is the son of A

A\$B means A is the mother of B

A%B means A is the husband of B

Along with the given two statements, three statements are given you have to decide whether the data provided along with the three statements are sufficient to answer the question.

The statements i, ii, iii given below can be used along with the above two statements I, II but cannot be combined together. The statements I, II above are combined.

16)

Statement I: L% C\$G; M#R%B\$L

Statement II: S@N\$R; S&D#Q

How is M related to S?

i: K@H%M; F\$Q#T

ii: V@L#R%B\$M

iii: S&J#Q; B\$L#R&M

A. Only ii

B. Only i

C. Either only i or only ii

D. Either only i or only iii

E. Only iii

17)

Statement I: L% C\$G; M#R%B\$L

Statement II: S@N\$R; S&D#Q

Who among the following is the son of L?

i: S@N\$R%B\$L%C

ii: Y@L%C&G; Q&D

iii: N\$R&L; G#L

A. Only i

B. Only ii

C. Either only i or only ii

D. Either only ii or only iii

E. Only iii

18)

Statement I: L% C\$G; M#R%B\$L

Statement II: S@N\$R; S&D#Q

Who among the following is the father of Q?

i: T&Q% S\$I@Q

ii: O@F\$Q&D; W%N\$S

iii: N&R%B\$L; D#Q% S

A. Only i

B. Only ii

C. Either only i or only ii

D. Either only ii or only iii

E. None of these

Directions (19-20): Each of the questions below consists of a question and two statements numbered I and II given below it.

Statement 1: In a certain coded language, "Mexican people are talented" is coded as "ar mg owxn", "Roasted chicken are unhealthy" is coded as "nwgkow md", "Tall people eat heavy" is coded as "oezdva mg".

Statement 2: In a certain coded language, "Most eaten fried chicken" is coded as "kf md ov ci", "Heavy industry eat most" is coded as "varjoekf", "Mind working are intelligent" is coded as "kd nr otow".

Along with the given two statements I, II, three statements i, ii, iii are given

you have to decide whether the data provided along with the three statements are sufficient to answer the question. The statements given below can be used along with the above two statements but cannot be combined together.

The statements I, II above are combined.

19) What is the code for “Working people eat vegan” in the given coded language?

I: In a certain coded language, “Most boys like vegan” is coded as “lf iokfbw”.

II: In a certain coded language, “Working heavy are vegan” is coded as “nr owvaho”.

III: In a certain coded language, “Mind game unhealthy vegan” is coded as “ot ns gkcw”.

- A. Only I
- B. Only II
- C. Either only II or only III

D. Either only I or only III

E. None of these

20) Which of the following determines the code “zdardpvw” in the given coded language?

I: In a certain coded language, “Brilliant talented unhealthy army” is coded as “gkvwxndp”.

II: In a certain coded language, “Mexican chicken roasted army” is coded as “md arvwnw”.

III: In a certain coded language, “Brilliant tall talented army” is coded as “zddpvwxn”.

- A. Only I
- B. Only III
- C. Either only I or only III
- D. Either only II or only III
- E. None of these

[Click Here to Get the Detailed Video Solution for the above given Questions](#)

Or Scan the QR Code to Get the Detailed Video Solutions



Answer Key with Explanation

Directions (1-5):

- 1) Answer: D
- 2) Answer: A
- 3) Answer: B
- 4) Answer: D

5) Answer: A

Final Arrangement

Person	Date	Experience
M	16 th March	8
O	21 st April	6
L	29 th May	5
Q	30 th July	12
N	1 st September	9
P	15 th October	15
R	27 th October	14

Persons getting the project –M, Q

We have,

- At least four persons joined after L whose experience is in an odd number.
- N joined two persons before the one has 14 years of experience.
- N and the one who has 14 years of experience joined either first or last in the company.

From the above condition, there are four possibilities.

Case1			Case2		
Person	Date	Experience	Person	Date	Experience
N			L		
L					
		14			
			N		
					14

Case3			Case1a		
Person	Date	Experience	Person	Date	Experience
			L		
L					
N			N		
		14			14

Again we have,

- The number of persons joined before N is the same as after the one who has 5 years of experience.
- The number of persons joined between N and L is the same as between Q and the one who has 15 years of experience.
- The one who has 14 years of experience joined immediately after the one who has 15 years of experience.

Case1			Case2		
Person	Date	Experience	Person	Date	Experience
N			L		
L		15	Q		
Q		14			5
			N		
					15
		5			14

Case3			Case1a		
Person	Date	Experience	Person	Date	Experience
			L		
L		5	Q		5
Q					
N			N		
		15			15
		14			14

Again we have,

- P joined two persons after Q.
- P joined three persons after the one who joined immediately after 21st April.

From the above condition, case2 and case1a get eliminated.

Case1			Case2		
Person	Date	Experience	Person	Date	Experience
N	21 st April		L		
L		15	Q		
Q		14			5
			P		
P			N		
					15
		5			14

Case3			Case1a		
Person	Date	Experience	Person	Date	Experience
	21 st April		L		
L		5	Q		5
Q					
N			N		
P		15			15
		14			14

Again we have,

- O joined before R who joined on 27th October and O joined after M.

- The one who has 8 years of experience joined three persons before the one who has 12 years of experience who joined on 30th July.
- N has experience which is an odd number.
- Q has twice the experience of O.
- The difference between the experience of O and N is the same as the difference between the N and Q.

From the above condition, case1 gets eliminated.

Case1			Case3		
Person	Date	Experience	Person	Date	Experience
N	21 st April	8	M		8
L		15	O	21 st April	6
Q		14	L		5
M	30 th July	12	Q	30 th July	12
P			N		9
O		7	P		15
R	27 th October	5	R	27 th October	14

Again we have,

- The one whose experience is an even number of years joined on the date which is twice of his experience and in the month which has an odd number of days.
- M does not join in January.
- One of the persons joined twelve days before R. One of them joined on 29th May.
- P does not join on 1st September.

From the above condition, case3 shows the final arrangement.

Case3		
Person	Date	Experience
M	16 th March	8
O	21 st April	6
L	29 th May	5
Q	30 th July	12
N	1 st September	9
P	15 th October	15
R	27 th October	14

Condition:

- The project is given to those people having total experience of (calculate their experience on the following date 1st August 2020) at least 11 years.

Case3		
Person	Date	Experience
M	16 th March	8+LMP(3 years 4 months)
O	21 st April	6+LMP(3 years 3 months)
L	29 th May	5+LMP(3 years 2 months)
Q	30 th July	12+LMP(3 years)
N	1 st September	9+LMP(2 years 11 months)
P	15 th October	15+LMP(2 years 9 months)
R	27 th October	14+LMP(2 years 9 months)

M, Q, N, P, and R have total experience of experience(in years) as 11,15, 11,17, and 16 respectively.

- The project is given to the person who also has 3 years of experience in the same organization (in LMP).

By comparing Date and Month the following sequence is obtained.

M and Q get the project.

6) Answer: C

Condition II applied, their pens will be subtracted from the person who sits extreme right of their rows.

$$25-17=8$$

$$22-16=6$$

$$8-6=2$$

7) Answer: B

The condition I applied, then their pens will be added to the person who sits opposite to them.

$$25+8=33$$

$$9+16=25, \text{ multiplication of unit digits} \rightarrow 3*5=15$$

8) Answer: C

$$16+8+9+25=58$$

9) Answer: B

Condition III applied, their pens will be thrice.

$$21*3=63$$

$$17*3=51 \rightarrow 63+51=114$$

10) Answer: D

Final Arrangement

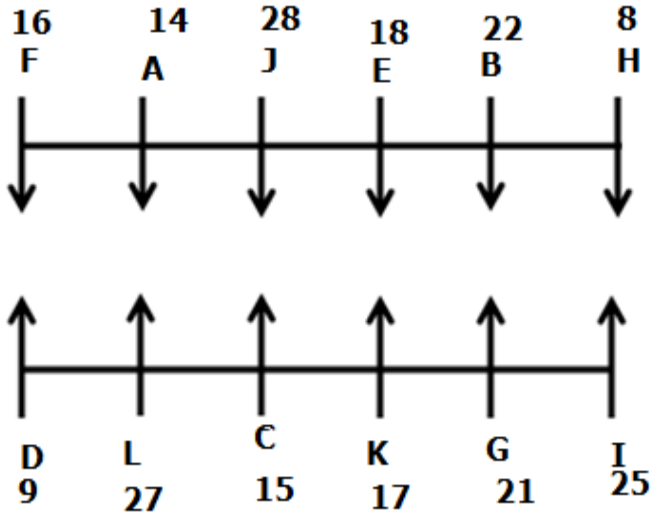

We have,

- J sits opposite to the one who sits third to the left of the one who has 25 pens.
- J does not sit at the end of the row.

From the above condition, there are two possibilities.

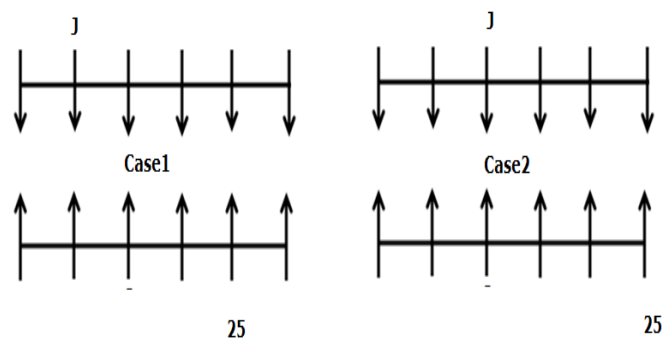

Again we have,

- Only two persons are sitting between B and the one who has half of the number of pens of J.
- B and J are not immediate neighbors but sits on the same row.
- B does not sit at the end of the row.

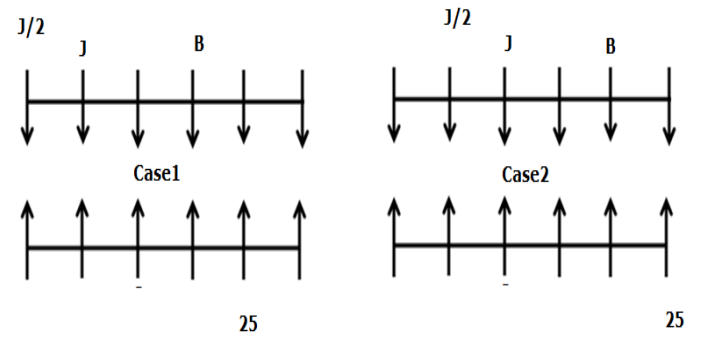

Again we have,

- The one who has 9 pens sits fourth to the left of the one who sits immediate left of I.
- Only three persons are sitting between L and I.
- The number of people sits to the left of the one who sits opposite to L is the same as people to the left of G.
- The one who has 15 pens sits second to the left of G.

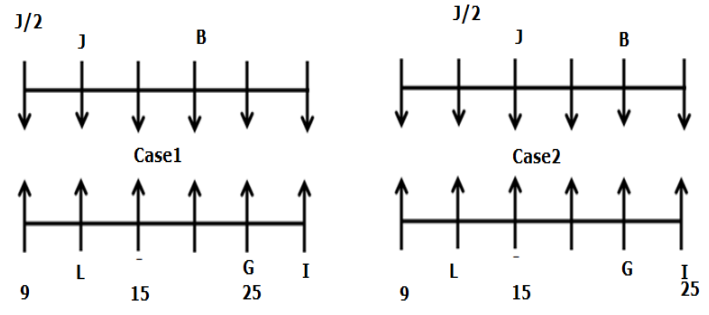

Again we have,

- K sits immediate right of C, neither of them sits at the end of the row.
- F has twice the pens of H.
- H has one pen less than D.
- D does not sit in the same row as E.
- F sits adjacent to neither J nor B.
- The number of people sits between D and I is the same as between F and H.

From the above condition, case1 gets eliminated.

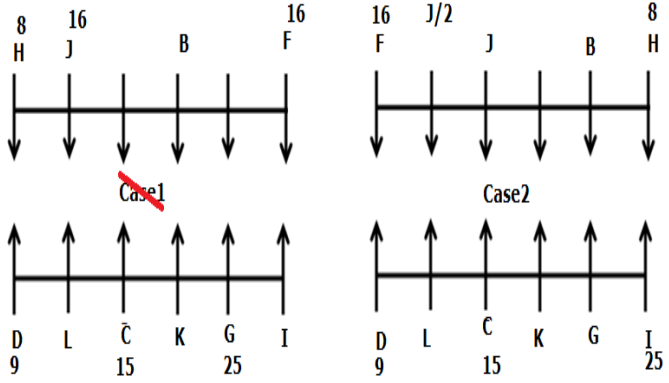

Again we have,

- The difference between the pens of C and I is the same as the difference between the pens of H and E.
- The difference between the pens of F and A is the same as between F and E.
- K has one pen less than the one who sits opposite to K.
- The sum of the pens of D and the one who sits second to the right of L is one less than the one who sits opposite to A.

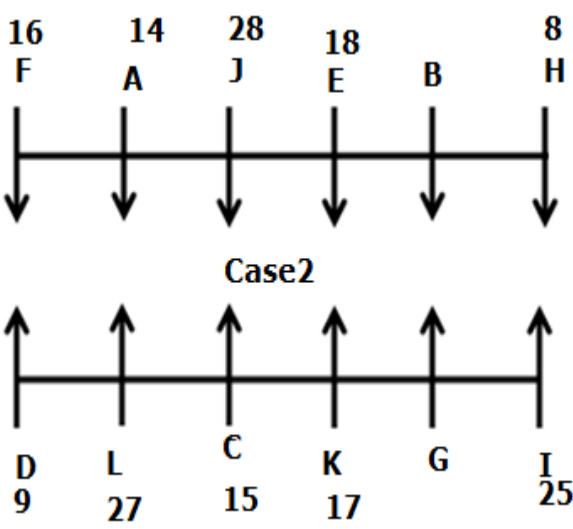

Again we have,

- The sum of the pens of A and H is equal to the pens of B.

- The difference between the pens of E and K is the same as between B and G.
- G does not have a prime number of pens.

From the above condition, case2 shows the final arrangement.

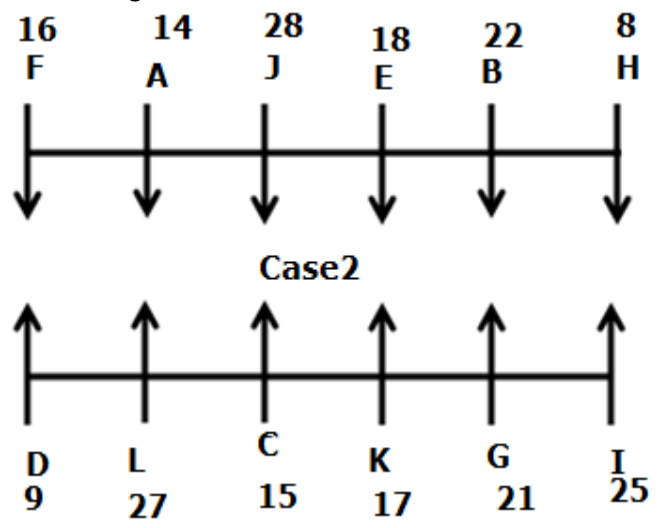

Directions (11-15):

- 11) Answer: C
- 12) Answer: E
- 13) Answer: E
- 14) Answer: A
- 15) Answer: B

Final Arrangement

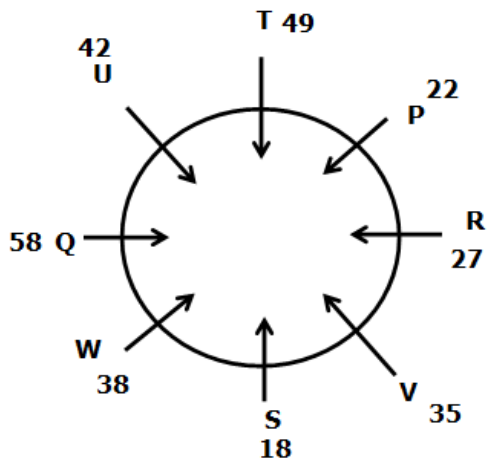

We have,

- U sits third to the left of the one who sits immediate right of the one whose age is 38 years.
- Two persons are sitting between U and S.

From the above condition, there are two possibilities.

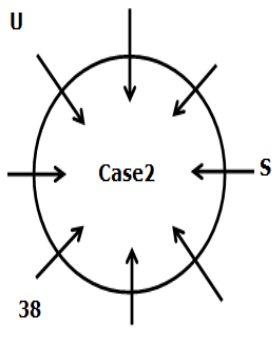
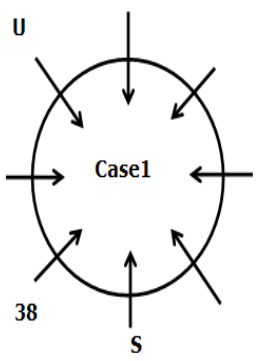

Again we have,

- The one whose age is 27 sits second to the right of S.
- V's age is an odd number and sits adjacent to S.

From the above condition, there are three possibilities.

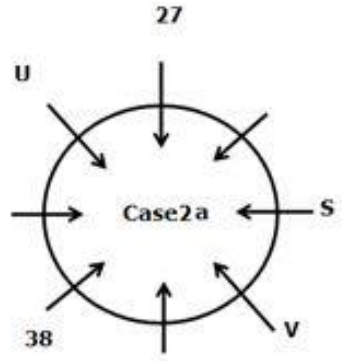
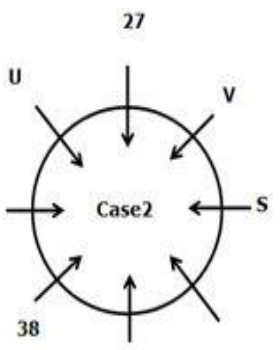
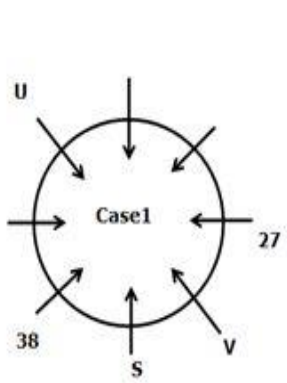

Again we have,

- Q sits second to the right of the one who sits opposite to S.
- The one who sits opposite Q sits immediate left of the one whose age is 22.
- T sits third to the left of W whose age is an even number.
- W does not sit opposite to U.
- W is adjacent to neither U nor P.
- The age of R is an odd number.

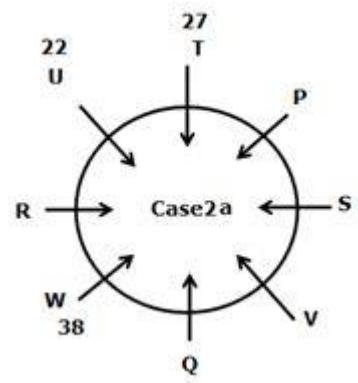
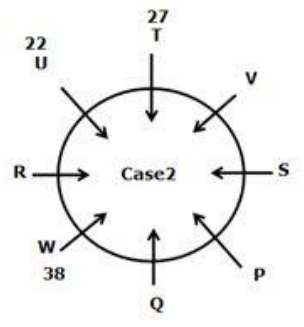
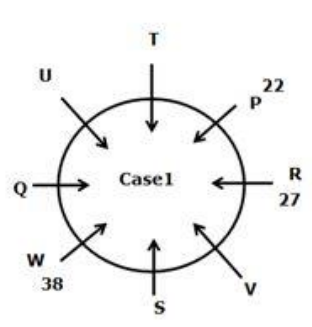

Again we have,

- The one whose age is 18 sits opposite to T.
- The age difference between W and Q is the same as between W and S.
- The sum of the age of S and U is two years more than Q.

From the above condition, case2 and case2a get eliminated.

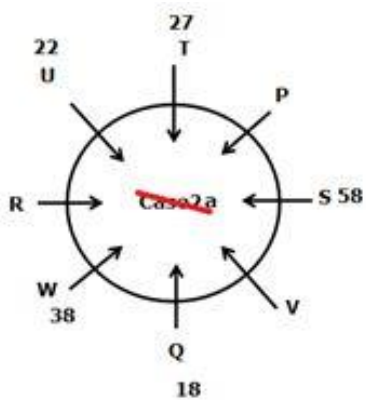
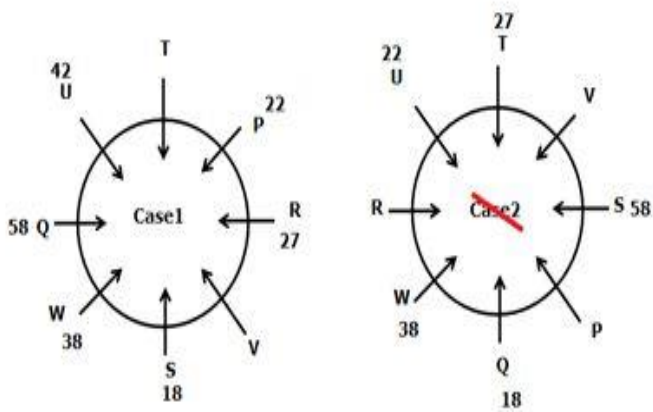
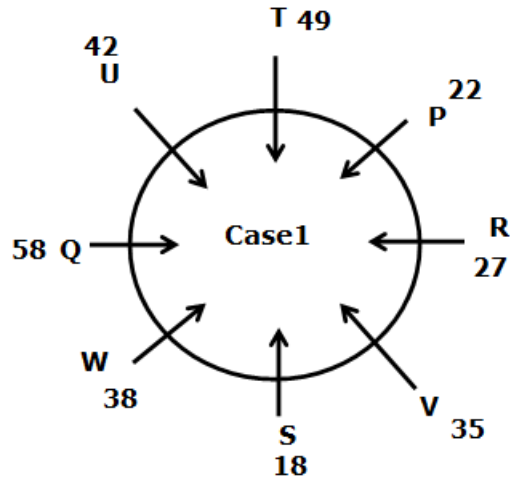

Again we have,

- R is younger than V whose age is not 49.
- One of the persons is 49 years old.
- The age difference between R and V is one year more than the age difference between U and T.

16) Answer: D

From the given two statements:

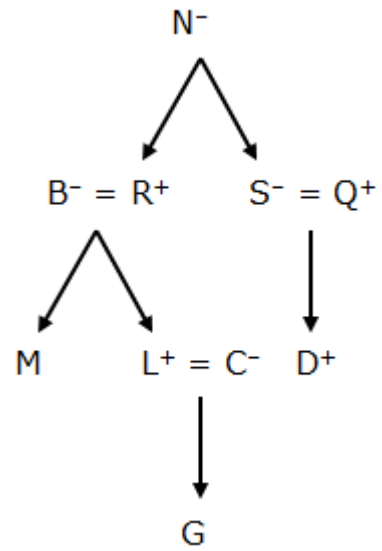

Using statement i:

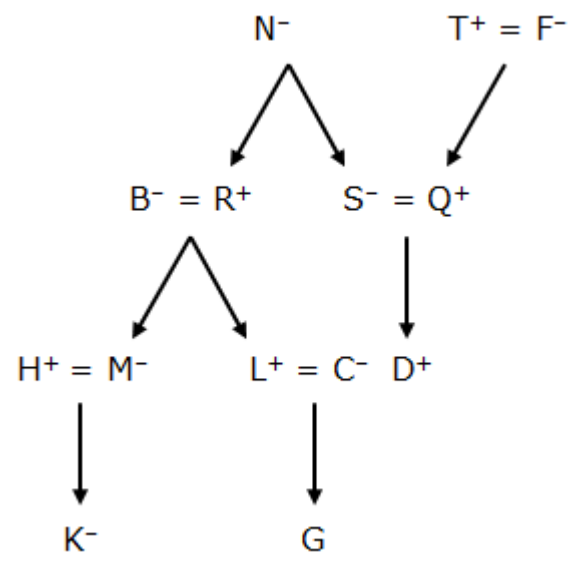

Using statement iii:

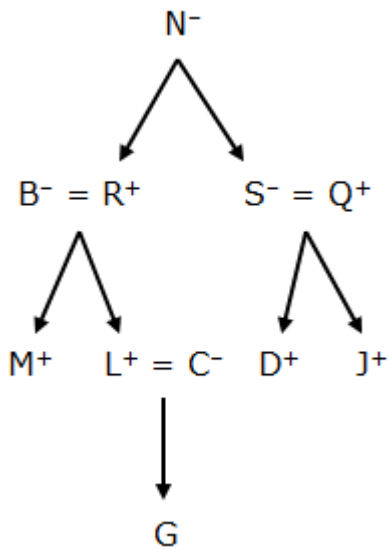

Hence, option D is correct.

17) Answer: B

From the given two statements:

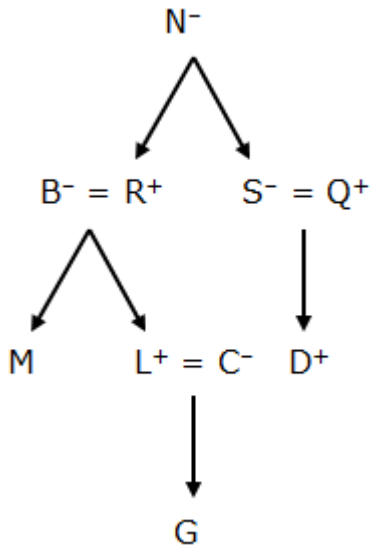

Using statement ii:

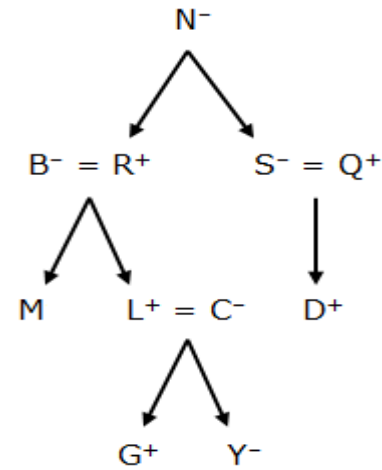

Hence, option B is correct.

18) Answer: E

From the given two statements:

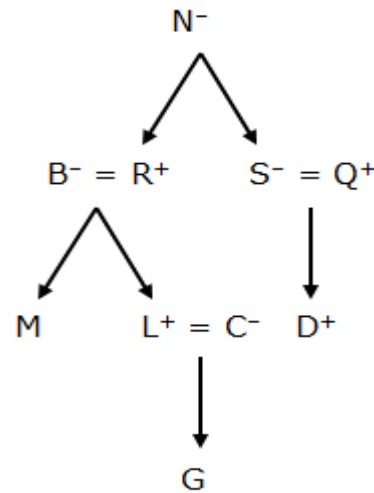

None of the statements determine the father of Q.

Hence, option E is correct.

19) Answer: B

From the given statements, the following were determined.

Word	Code
People	mg
Are	ow
Chicken	md
Tall	zd
Industry	rj
Most	kf
Mexican/talented	ar/xn
Roasted/unhealthy	nw/gk
Heavy/eat	oe/va
Eaten/fried	ov/ci
Mind/working/intelligent	kd/nr/ot

Using statement II:

Word	Code
Working	nr
Heavy	va
Eat	oe
Vegan	ho

Therefore, “Working people eat vegan” is coded as “nr mg oe ho”.

Hence, option B is correct.

20) Answer: C

From the given statements, the following were determined.

Word	Code
People	mg
Are	ow
Chicken	md
Tall	zd
Industry	rj
Most	kf
Mexican/talented	ar/xn
Roasted/unhealthy	nw/gk
Heavy/eat	oe/va
Eaten/fried	ov/ci
Mind/working/intelligent	kd/nr/ot

Using statement I:

I: In a certain coded language, “Brilliant talented unhealthy army” is coded as “gkvwxndp”.

Word	Code
Talented	xn
Mexican	ar
Unhealthy	gk
Roasted	nw
Brilliant/army	vw/dp

Therefore, “zd ar dp vw” is determined as “Tall Mexican Brilliant Army”.

Using statement III:

III: In a certain coded language, “Brilliant tall talented army” is coded as “zd dp vw xn”.

Word	Code
Tall	zd
Talented	xn
Mexican	ar
Brilliant/army	vw/dp

Therefore, “zd ar dp vw” is determined as “Tall Mexican Brilliant Army”.

Hence, option C is correct.

Dear Friends, this is the Special Paid Bundle PDF Course which was made because of the Hard work of Our Experts Team. This PDF Course consists of High-Standard Questions on Reasoning, Quants, English, Current Affairs Quiz, Static GK Quiz and Banking Awareness Quiz Exactly on Exam Level. Total 40,000 Questions and Course Duration is of 50 Days for each exam. If anyone got this PDF without purchasing it, kindly buy this PDF Officially using the link given below. This will encourage us to work harder to produce high quality content for you in upcoming days.

[Get Our Special Grand Bundle PDF Course for All Upcoming Bank Exams](#)

Dear Friends, this is the Special Paid Bundle PDF Course which was made because of the Hard work of Our Experts Team. This PDF Course consists of High-Standard Questions on Reasoning, Quants, English, Current Affairs Quiz, Static GK Quiz and Banking Awareness Quiz Exactly on Exam Level. Total 40,000 Questions and Course Duration is of 50 Days for each exam. If anyone got this PDF without purchasing it, kindly buy this PDF Officially using the link given below. This will encourage us to work harder to produce high quality content for you in upcoming days.

[Get Our Special Grand Bundle PDF Course for All Upcoming Bank Exams](#)

Grand Bundle PDF Course 2021

Exams Covered:

SBI Clerk | SBI PO | IBPS RRB PO |
IBPS RRB Clerk | IBPS PO | IBPS Clerk

Separate PDF Course for All Major **Bank Pre + Mains** Exams

- ➔ Total No. of Ques.: **40,000+**
- ➔ Question in Bilingual (**Eng & Hindi**)
- ➔ Answers With Detailed **Video Solution**
- ➔ Provides you **50 days Study Planner** for each exams
- ➔ **Covers all types** of questions in each topic
- ➔ Questions in **Exact Exam Level**
- ➔ All Our PDFs are **Downloadable**
- ➔ **100% Satisfaction Assured** & It's Worthy for your money

Quantitative Aptitude

Directions (01 – 05): Read the following information carefully and answer the questions based on it.

The table given below shows the partial information about the number of bags manufactured by the companies P, Q, R, S and T. They manufactured Sports bags and office bags. The type of bags is further categorized into mid-range and Heavy range.

Total number of bags = Sports bags + office bags

bags

Sports bags = Mid-range + Heavy range

Office bags = Mid-range + Heavy range

Company	Percentage of Office bags manufactured	Number or percentage of Mid-range office bags out of total number of office bags manufactured	Number or percentage of Mid-range sports bags out of total number of sports bags manufactured	Total number of Heavy range bags manufactured
P	[A]%	50%	75%	[B]
Q	65%	[C]	60%	[D]
R	45%	4320	[E]	5760
S	[F]%	62.5%	[G]%	[H]
T	68%	4896	62.5%	[J]

1) If the value of [D] is 9824 which is 576 less than [C], find the total number of bags manufactured by the company Q.

- a) 28400
- b) 24000
- c) 25600
- d) 30000
- e) None of these

2) For company P, if the value of [A] % is 72%, then the total number of mid-range bags is approximately how much percent of that of heavy range bags?

- a) 135%
- b) 138%
- c) 131%
- d) 133%
- e) 140%

3) If the value of E is (600/11) %, then, find the difference between the total number of mid-range bags manufactured by company R and the number of mid-range office bags manufactured by company T.

- a) 3744
- b) 3474
- c) 3764
- d) 3677
- e) None of these

4) For company T, if the number of heavy range bags sold by the company is 250% of mid-range sports bags and the number of heavy range unsold bags is 8736 less than that of sold bags. Find the total number of bags manufactured by the company.

- a) 28800
- b) 19200
- c) 25600
- d) 12800
- e) None of these

5) For company S, if the ratio of the value of [F] % and [G] % is 144:125 respectively and the value of [F]% is 64%, find the number of heavy range sports bags manufactured, if the difference between the number of mid-range bags and heavy range bags is 4800.

- a) 3880
- b) 3680
- c) 3480
- d) 3840
- e) None of these

Directions (06 – 10): Read the following information carefully and answer the questions based on it. The pie chart given below shows the percentage breakup of the number of people registered on “CO-WIN” from five different states and the percentage breakup of the number of females registered from these five states.

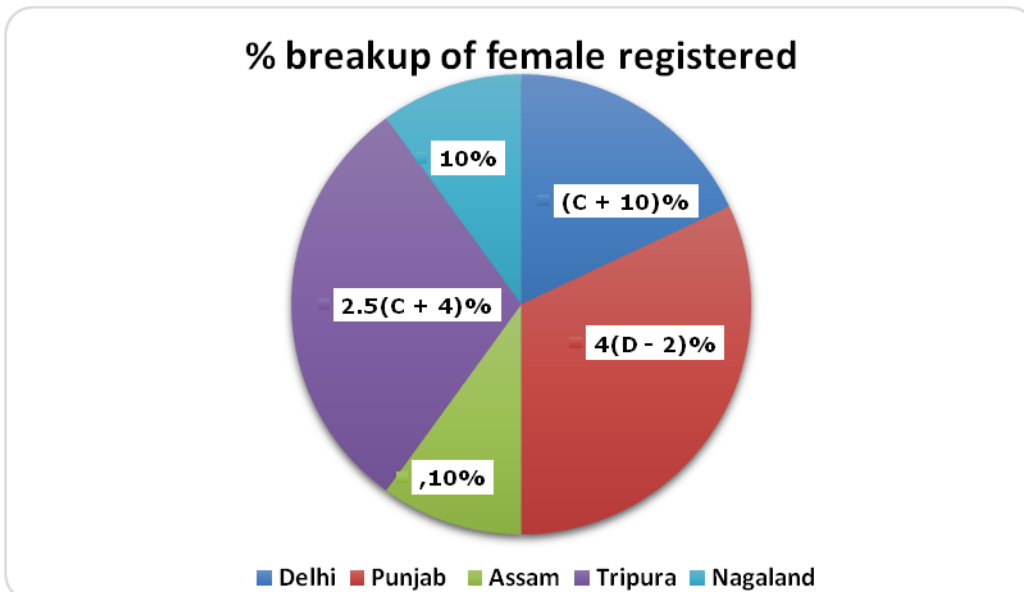
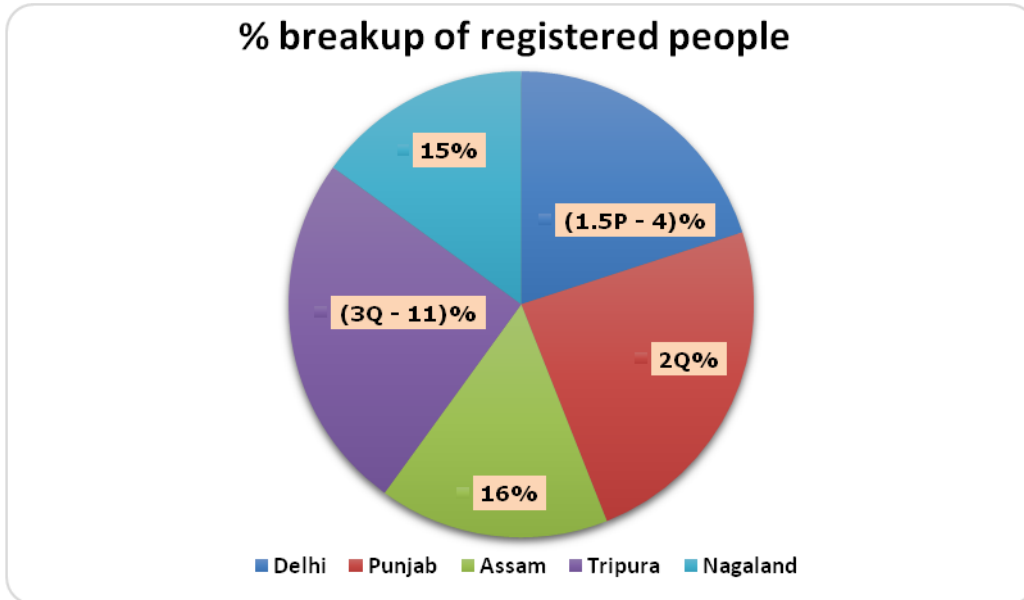

Note:

a) Number of males registered from Delhi and Tripura is 720 and 600 respectively. P, Q, C and D all are positive integers.

b) In Nagaland, the number of females and the total number of people is the least among the five cities.

6) The total number of males registered from all the states together is how much percent more or less than that of females?

- a) 40%
- b) 25%
- c) 20%
- d) 15%
- e) None of these

7) Find which of the following statement(s) is/are true in the context of the above-given data.

I. Out of the registered people from Delhi, 50% were males

II. Difference between males from Punjab and females from Assam, when divided by 13 leaves remainder 9

III. Males from Nagaland are 70% more than females.

- a) I only
- b) II and III only
- c) I and III only
- d) I and II only
- e) None of these

8) Find which of the following matches is possible in the context of the above-given data.

Box 1	Box 2
1) Punjab	I. Central angle belonging to male $> 50^\circ$
2) Tripura	II. Males $<$ Females
3) Assam	III. Difference between males and females $>$ 20% of total males

Match A) 1 – I, 2 – II, 3 – III

Match B) 1 – III, 2 – I, 3 – I

Match C) 1 – I, 2 – II, 3 – I

Match D) 1 – II, 2 – I, 3 – II

- a) B and A only
- b) C and D only
- c) A, D and B only
- d) B and C only
- e) None of these

9) In Punjab, 75% of females and 87.5% of males registered got vaccinated. If the government collected Rs.80 for a vaccination, then find the total revenue generated by the government.

- a) Rs.108260
- b) Rs.108360
- c) Rs.108860
- d) Rs.107160
- e) None of these

10) If all the data related to males are arranged in a pie chart, then find the difference between the central angle of Delhi and Tripura.

- a) 13.5°
- b) 27°
- c) 16°
- d) 14.5°
- e) None of these

Directions (11 – 15): Read the following information carefully and answer the questions based on it.

There are two online coaching platforms– P and Q dealing with coaching for two exams – CAT and Bank.

I. Number of students preparing for the CAT exam in Q is one-third of the total number of students preparing for both the exams in P.

II. Number of students preparing for the CAT exam in P is represented by the positive root of the equation, where M is the positive integer.

$$K^2 + 42MK - 288M^2 = 0$$

III. Number of students preparing for the Bank exam in Q is 4 more than 50% of students preparing for the same exam in P.

IV. Number of students preparing for the Bank exam in P is represented by the missing term in the given series, where N is the positive integer.

$$8N, (?), 8N, 17N, 41N$$

11) If the number of students preparing for CAT Exam and Bank Exam in Q is the same, then find the number of students preparing for CAT in P is how much more than Q.

- a) 16

- b) 8
- c) 4
- d) 10
- e) Can't be determined

12) If the number of students preparing for Bank in Q is 244, then, find the difference between the total number of students in both institutes together. (Total number of students in P is more than Q)

- a) $6M + 76$
- b) $8M + 38$
- c) $4M + 76$
- d) $8(M/2 + 38)$
- e) None of these

13) If the total number of students in P is 30 more than that of Q, then find the total number of students preparing for Bank in both P and Q?

- a) 94
- b) 184
- c) 274
- d) 178
- e) Can't be determined

14) If the total number of students in P is 30 more than that of Q, and the number of girls preparing for CAT in P is 20 which is 50% of the total number of girls in P, then, find the number of boys preparing Bank in P.

- a) 60
- b) 20
- c) 40
- d) 16

e) None of these

15) If the number of students preparing for CAT and bank in Q is the same, then find the maximum possible number of students in P and Q together, if M is less than 20.

- a) 372
- b) 470
- c) 362
- d) 620
- e) None of these

Direction (16 – 18): Read the following information carefully and answer the questions based on it.

There is a number series given to you that follows a certain pattern.

Series 1. (P), (Q), (R), (S), (T), 3193

Following facts are also known about the variables in the series.

- Value of P is the smaller root of the equation, $P^2 - 116P + 228 = 0$
- $Q = (A/13 + 1)$
- $R = [\text{LCM of } (A, B) / \text{HCF of } (42, 77)] - 53$
- $S = 2 \times (R + 28) - \text{HCF of } (A, B)$
- $T = 150\% \text{ of } (S + 3A + 7B) - 51$
- $(A \times B) = 546$, Where $B > 5$ and $A > B$
- $3A + 15B = 339$

16) If there is another series that starts with 50% of (S – R), follow the same pattern as that of series 1, and then find the 4th element of the series

- a) 2017
- b) 6097

- c) 1017
- d) 253
- e) None of these

17) If there is another sequence (R), (S), 380, 1080, (?), then find the value of the question mark (?).

- a) 2040
- b) 2080
- c) 1980
- d) 2240
- e) None of these

18) The value of T is approximately what percentage more or less than S?

- a) 410% more
- b) 412% less
- c) 403% more
- d) 406% more
- e) 400% less

Directions (19 – 20): Read the following information carefully and answer the questions based on it.

Two series are given below numbered – 1 and 2 given to you. Series 1 consists of a missing number and series 2 consists of a wrong number. Both series follow the same pattern.

Series 1. 12, 36, 68, (?), 126, 164

Series 2. 120, 144, 176, 208, 244, 272

19) Find the value of question mark (?) in series 1.

- a) 108
- b) 98

- c) 100
- d) 128
- e) None of these

20) Find the wrong term in series 2?

- a) 176

- b) 244
- c) 208
- d) 272
- e) 144

[Click Here to Get the Detailed Video Solution for the above given Questions-Will Update Coming Soon](#)

Or Scan the QR Code to Get the Detailed Video Solutions

Answer Key with Explanation

1) Answer: C

Let the total number of bags manufactured by the company Q = $100a$

Number of office bags in company Q = 65% of $100a = 65a$

Number of sports bags in company Q = $100a - 65a = 35a$

Number of mid-range office bags manufactured by company Q = $9824 + 576 = 10400$

So, number of heavy range office bags manufactured by company Q = $65a - 10400$

Number of heavy range sports bags manufactured by company Q = 40% of $35a =$

$14a$

Now,

$$(65a - 10400) + 14a = 9824$$

$$\text{Value of } a = 20224/79 = 256$$

So, total number of bags manufactured by company Q = $256 \times 100 = 25600$

Hence, the answer is option C

2) Answer: D

For company P,

Let the total number of bags manufactured = $100a$

Number of office bags manufactured = 72% of $100a = 72a$

Number of sports bags manufactured = $100a - 72a = 28a$

Number of mid-range office bags = 50% of $72a = 36a$

Number of heavy range office bags = $72a - 36a = 36a$

Number of mid-range sports bags = 75% of $28a = 21a$

Number of heavy range sports bags = $28a - 21a = 7a$

$$\text{Required \%} = [(36a + 21a) / (36a + 7a)] \times 100 = 132.5\%$$

Hence, answer is option D.

3) Answer: A

For company R,

Let total number of bags manufactured by the company = $100a$

Number of heavy range office bags manufactured by company = $(45\% \text{ of } 100a - 4320) = (45a - 4320)$

Number of heavy range sports bags manufactured by company = $(500/11) \% \text{ of } 55a = 25a$

Now, $(45a - 4320) + 25a = 5760$

So, value of $a = 10080/70 = 144$

So, number of mid-range bags manufactured by company R = $4320 + (600/11) \% \text{ of } 55a = 4320 + 30 \times 144 = 8640$

Number of mid-range office bags manufactured by company T = 4896

Required difference = $8640 - 4896 = 3744$

Hence, the answer is option A

4) Answer: B

For company T,

Let number of bags manufactured = $1600a$

Number of office bags manufactured = $1088a$

Number of sports bags manufactured = $1600a - 1088a = 512a$

Number of mid-range office bags manufactured = 4896

Number of heavy range office bags manufactured = $1088a - 4896$

Number of mid-range sports bags manufactured = $62.5\% \text{ of } 512a = 320a$

Number of heavy range sports bags manufactured = $512a - 320a = 192a$

Total number of heavy range bags sold = $320a \times 250\% = 800a$

Number of heavy range bags unsold = total heavy range bags – sold heavy range bags = $(1088a - 4896 + 192a) - 800a = 480a - 4896$

Now, $800a - (480a - 4896) = 8736$

$320a = 3840$

So, value of $a = 12$

So, total number of bags manufactured by company = $12 \times 1600 = 19200$

Hence answer is option B

5) Answer: D

For company S,

Let total number of bags manufactured by company = $100a$

Number of office bags manufactured = $100a \times 64\% = 64a$

Number of sports bags manufactured = $100a - 64a = 36a$

Number of mid-range office bags = $62.5\% \text{ of } 64a = 40a$

Number of heavy range office bags = $64a - 40a = 24a$

Number of mid-range sports bags manufactured = $(125/144 \times 64) \% \text{ of } 36a = 20a$

Number of heavy range sports bag manufactured = $36a - 20a = 16a$

Now, $(40a + 20a) - (24a + 16a) = 4800$

So, value of $a = 240$

So, the number of heavy range sports bags manufactured = $16 \times 240 = 3840$.

Directions (6-10):

Number of people registered from (Assam + Nagaland)

$$= 16\% + 15\% = 31\%$$

So, number of people registered from (Delhi + Punjab + Tripura) = $(100\% - 31\%) = 69\%$

$$\text{Now, } (1.5P - 4)\% + 2Q\% + (3Q - 11)\% = 69\%$$

$$1.5P + 5Q = 84$$

$$3P + 10Q = 168$$

$$Q = (168 - 3P)/10 \dots\dots\dots (1)$$

Value of Q should be divisible by 10, that means $(168 - 3P)$ has 0 as a unit place digit.

So, 3P must have 8 as a unit digit.

Only when 3 is multiplied with 6, gives unit digit 8.

So the possible value of P = 6, 16, 26....

$$\text{If } P = 6, \text{ then } Q = (168 - 3 \times 6)/10 = 15$$

Also, we know that the total number of people registered from Nagaland is minimum. So, no other state other than Nagaland has a percentage distribution of less than 15%.

$$\text{When } P = 6, \text{ \% distribution of Delhi} = 1.5 \times 6 - 4 = 5\% \text{ (not possible)}$$

$$\text{If } P = 16, \text{ then } Q = 12$$

$$\text{Percentage Distribution of Delhi} = 1.5 \times 16 - 4 = 20\%$$

$$\text{Percentage Distribution of Punjab} = 2 \times 12 = 24\%$$

$$\text{Percentage Distribution of Tripura} = 3 \times 12 - 11 = 25\%$$

This pair of values is possible.

$$\text{If } P = 26, \text{ then } Q = 9$$

$$\text{Percentage Distribution of Delhi} = 1.5 \times 26 - 4 = 35\%$$

$$\text{Percentage Distribution of Punjab} = 2 \times 9 = 18\%$$

$$\text{Percentage Distribution of Tripura} = 3 \times 9 - 11 = 16\%$$

This pair is possible

$$\text{If } P = 36, Q = 6$$

$$\text{Percentage Distribution of Punjab} = 2 \times 6 = 12\% \text{ (not possible)}$$

If we further increase the value of P, the value of Q will be less than 6. And the percentage of Punjab will be decreased, so no need to check further values.

Now, the number of females from (Delhi + Punjab + Tripura) = $100 - 10 - 10 = 80\%$ of total females registered.

$$\text{So, } (C + 10)\% + 4(D - 2)\% + 2.5(C + 4)\% = 80\%$$

$$3.5C + 4D = 68$$

$$7C + 8D = 136$$

$$\text{Value of } D = (17 - 7C) / 8$$

C should be exact multiple of 8,

$$\text{If } C = 8, \text{ then } D = 10$$

$$\text{Percentage Distribution of Delhi} = 8 + 10 = 18\%$$

$$\text{Percentage Distribution of Punjab} = 4 \times (10 - 2) = 32\%$$

$$\text{Distribution of Tripura} = 2.5 \times (8 + 4) = 30\%$$

This pair is possible

$$\text{If } C = 16 \text{ then } D = 3$$

$$\% \text{ Distribution of Punjab} = 4 \times (4 - 3) = 4\% \text{ (Not possible)}$$

$$\text{If } C = 24, \text{ then } D \text{ negative}$$

So, we have 1 pair of possible values.

State	Percentage Of People	Percentage Of Female
Delhi	20% / 35%	18%
Punjab	24% / 18%	32%
Assam	16%	10%
Tripura	25% / 16%	30%
Nagaland	15%	10%

Also, we have a number of males from Delhi is 720 and from Tripura is 600

Case 1.

Let total people and number of females be 'a' and 'b' respectively

$$\text{So, } 20\% \times a - 18\% \times b = 720$$

$$10\% \times a - 9\% \times b = 360 \dots \dots \dots (1)$$

$$\text{Also, } 25\% \times a - 30\% \times b = 600$$

$$5\% \times a - 6\% \times b = 120 \dots \dots \dots (2)$$

Apply, 2 x equation (1) - equation (2), we get
3% of b = 120

$$\text{Value of } b = 4000$$

$$\text{So, value of } a = 7200$$

Case 2.

$$35\% \times a - 18\% \times b = 720 \dots \dots \dots (1)$$

$$16\% \times a - 30\% \times b = 600 \dots \dots \dots (2)$$

Apply, 5/3 x equation (1) – equation (2), we get
 $127/3\% \times a = 600$

So, value of a = $(600 \times 3 \times 100) / 127 =$ (not an integer)

So, this pair is not possible.

Now, we can calculate all the related data.

State	Total People	Female	Male
Delhi	1440	720	720
Punjab	1728	1280	448
Assam	1152	400	752
Tripura	1800	1200	600
Nagaland	1080	400	680
Total	7200	4000	3200

6) Answer: C

According to the question,

$$\text{Total number of males registered} = 3200$$

$$\text{Number of females registered} = 4000$$

$$\text{The required percentage} = (4000 - 3200)/4000 \times 100 = 20\%$$

7) Answer: E

Statement I.

$$\text{Males in Delhi} = 720$$

$$\text{Females in Delhi} = 720$$

$$\text{The required percentage} = 720/1440 \times 100 = 50\%$$

This statement is true.

Statement II. Males from Punjab = 448

$$\text{Females from Assam} = 400$$

$$\text{Difference when divided by 13} = 48/13 = \text{remainder is 9}$$

This statement is true.

$$\text{Statement III. Males from Nagaland} = 680, \text{ Females} = 400$$

$$\text{The required percentage} = (680 - 400) = 280/400 \times 100 = 70\%$$

This statement is true.

8) Answer: D

I. Central angle belongs to male > 50°

Punjab = $448/3200 \times 360 = 50.4^0$ (follow)
 Tripura and Assam have more males than Punjab then, obviously they have more than 50^0 .

II. Males < Females

Punjab and Tripura have males less than females.

III. Difference between males and females > 20% of total males

20% of 3200 = 640

Punjab = $1280 - 448 = 832$ (follow)

Tripura = $1200 - 600 = 600$ (Not follow)

Assam = $752 - 400 = 352$ (Not follow)

9) Answer: E

Total revenue generated by the government = $80 \times (1280 \times 75\% + 448 \times 87.5\%) = \text{Rs.}108160$

10) Answer: A

Required difference = $[(720 - 600)/3200] \times 360^0 = 13.5^0$

Directions (11-15):

Solving quadratic equation,

$$K^2 + 42MK - 288M^2 = 0$$

$$K^2 + 48MK - 6MK - 288M^2 = 0$$

$$(K + 48M)(K - 6M) = 0$$

So possible value of K = 6M, - 48M

So, number of students preparing for CAT in P = 6M

Solving number series,

$$8N \times 0.5 + N = 5N$$

$$5N \times 1 + 3N = 8N$$

$$8N \times 1.5 + 5N = 17N$$

$$17N \times 2 + 7N = 41N$$

So, the number of students preparing for the bank Exam in P = 5N

Total number of students in P = 6M + 5N

Number of students preparing for the CAT exam in Q is one-third of the total students preparing for exams in P.

So, the number of students preparing for the CAT exam in Q = $1/3 \times (6M + 5N)$

Number of students preparing for the Bank exam in Q is 4 more than 50% of students preparing for the same exam in P.

So, number of students preparing for Bank exam in Q = $4 + 5N/2 = (8 + 5N)/2$

Exams	P	Q
CAT	6M	$(6M + 5N)/3$
Bank	5N	$(8 + 5N)/2$

11) Answer: B

According to the question,

Number of students preparing for CAT and for bank is same in Q

$$\text{Now, } (6M + 5N)/3 = (8 + 5N)/2$$

$$12M + 10N = 24 + 15N$$

$$12M - 5N = 24 \dots \dots \dots (1)$$

We need to find the value of = $6M - 1/3 \times (6M + 5N) = (12M - 5N)/3$

So, required value = $24/3 = 8$

12) Answer: C

According to Question,

$$(8 + 5N)/2 = 244$$

Value of N = 96

Total number of students = $(6M + 5N) - [1/3 \times (6M + 5N) + (8 + 5N)/2]$

$$= \frac{2}{3} \times (6M + 480) - 244$$

$$= 4M + 76$$

Hence answer is option C

13) Answer: A

$$\text{Total number of students in P} = (6M + 5N)$$

$$\text{Total number of students in Q} = (6M + 5N)/3 +$$

$$(8 + 5N)/2 = (12M + 25N + 24)/6$$

$$\text{Now, } (6M + 5N) - (12M + 25N + 24)/6 = 30$$

$$24M + 5N = 204$$

$$\text{Value of N} = (204 - 24M)/5$$

$(204 - 24M)/5$ should be exactly divisible by 5.

So, the unit digit should be 0 or 5.

For unit digit 5, $24M$ should have unit 9. If we multiply any number with 4, the unit digit can't be 9.

For unit digit 0, $24M$ must have the unit digit 4.

Multiply with 6 we can get unit digit as 4

$$24 \times 6 = 4 \text{ (unit digit)}$$

$$\text{If } M = 6, \text{ then } N = 12$$

Next value of $M = 16$, then $N = 204 - 24 \times 16$ gives Negative value.

So, the possible value of $M = 6$ and $N = 12$

So, number of students preparing for bank

$$\text{exam} = 5N + (8 + 5N)/2 = 94$$

Hence answer is option A

14) Answer: C

Consider the calculated values in question number 13, $M = 6$ and $N = 12$ when P is 30 more than Q .

$$\begin{aligned} \text{Number of students preparing for CAT in P} &= 6 \\ \times 6 &= 36 \end{aligned}$$

$$\text{Number of girls preparing for CAT in P} = 20$$

$$\begin{aligned} \text{Number of boys preparing for CAT in P} &= 36 - \\ 20 &= 16 \end{aligned}$$

$$\text{Total number of girls in P} = 2 \times 20 = 40$$

$$\text{Total number of students in P} = 6M + 5N = 96$$

$$\text{Total number of boys in P} = 96 - 40 = 56$$

$$\begin{aligned} \text{Number of boys preparing for Bank in P} &= 56 - \\ 16 &= 40 \end{aligned}$$

Hence answer is option C

15) Answer: B

We have already calculated,

$$(6M + 5N)/3 = (8 + 5N)/2$$

$$12M + 10N = 24 + 15N$$

$$12M - 5N = 24$$

$$M = 2 + 5N/12$$

N is exact multiple of 12

$$\text{If } N = 12, \text{ then } M = 7$$

$$\text{If } N = 24 \text{ then } M = 12$$

Value of M is less than 20,

So maximum value of $M = 17$ and $N = 36$

Exams	P	Q	Total
CAT	102	94	196
Bank	180	94	274
Total	282	188	470

Hence answer is option B

Direction (16 – 18):

$$P^2 - 116P + 228 = 0$$

$$(P - 2) \times (P - 114)$$

Possible value of $P = 2$

Now all values are depending on A, B

$$\text{We have } A \times B = 546 \text{ (} A > B \text{)}$$

$$546 = 2 \times 3 \times 7 \times 13$$

Value of A	Value of B
91	6
78	7
39	14
26	21

Also, we have $3A + 15B = 339$

So, possible value of $A = 78$ and $B = 7$

Value of $Q = (78/13 + 1) = 7$

Value of $R = [\text{LCM of } (78, 7) / \text{HCF of } (42, 77)] - 53 = ((7 \times 78) / 7) - 53 = 25$

Value of $S = 2 \times (25 + 28) - \text{HCF of } (78, 7) = 106 - 1 = 105$

Value of $T = 150\% \text{ of } (105 + 3 \times 78 + 7 \times 7) - 51 = 531$

Now pattern of series,

$$2 \times 2 + 3 = 7$$

$$7 \times 3 + 4 = 25$$

$$25 \times 4 + 5 = 105$$

$$105 \times 5 + 6 = 531$$

$$531 \times 6 + 7 = 3193$$

16) Answer: C

According to Question,

$$1^{\text{st}} \text{ term} = 50\% \text{ of } (105 - 25) = 40$$

$$2^{\text{nd}} \text{ term} = 40 \times 2 + 3 = 83$$

$$3^{\text{rd}} \text{ term} = 83 \times 3 + 4 = 253$$

$$4^{\text{th}} \text{ term} = 253 \times 4 + 5 = 1017$$

Hence answer is option C

17) Answer: B

$$25 \times 5 - 20 = 105$$

$$105 \times 4 - 40 = 380$$

$$380 \times 3 - 60 = 1080$$

$$1080 \times 2 - 80 = 2080$$

Hence, the answer is option B

18) Answer: D

Value of $T = 531$

Value of $S = 105$

The required percentage = $(531 - 105)/105 \times 100 = 405.71\% = 406\%$

Hence answer is option D

Direction (19 – 20):

Series 1.

Logic = Number with difference of 8 +

Multiplication of 2 consecutive composite number, number starts from 4

$$12 + (4 \times 6) = 36$$

$$20 + (6 \times 8) = 68$$

$$28 + (8 \times 9) = 100$$

$$36 + (9 \times 10) = 126$$

$$44 + (10 \times 12) = 164$$

Missing number is 100

19) Answer: C

According to the question,

Value of question mark = 100

Hence answer is option C

20) Answer: B

Series 2.

$$120 + (4 \times 6) = 144$$

$$128 + (6 \times 8) = 176$$

$$136 + (8 \times 9) = 208$$

$$144 + (9 \times 10) = 234 \text{ Not}(244)$$

$$152 + (10 \times 12) = 272$$

Wrong number is 244

Hence, the answer is option B.

Dear Friends, this is the Special Paid Bundle PDF Course which was made because of the Hard work of Our Experts Team. This PDF Course consists of High-Standard Questions on Reasoning, Quants, English, Current Affairs Quiz, Static GK Quiz and Banking Awareness Quiz Exactly on Exam Level. Total 40,000 Questions and Course Duration is of 50 Days for each exam. If anyone got this PDF without purchasing it, kindly buy this PDF Officially using the link given below. This will encourage us to work harder to produce high quality content for you in upcoming days.

[Get Our Special Grand Bundle PDF Course for All Upcoming Bank Exams](#)

Dear Friends, this is the Special Paid Bundle PDF Course which was made because of the Hard work of Our Experts Team. This PDF Course consists of High-Standard Questions on Reasoning, Quants, English, Current Affairs Quiz, Static GK Quiz and Banking Awareness Quiz Exactly on Exam Level. Total 40,000 Questions and Course Duration is of 50 Days for each exam. If anyone got this PDF without purchasing it, kindly buy this PDF Officially using the link given below. This will encourage us to work harder to produce high quality content for you in upcoming days.

[Get Our Special Grand Bundle PDF Course for All Upcoming Bank Exams](#)

Grand Bundle PDF Course 2021

Exams Covered:
SBI Clerk | SBI PO | IBPS RRB PO |
IBPS RRB Clerk | IBPS PO | IBPS Clerk

Separate PDF Course for All Major **Bank Pre + Mains** Exams

- ➔ Total No. of Ques.: **40,000+**
- ➔ Question in Bilingual (**Eng & Hindi**)
- ➔ Answers With Detailed **Video Solution**
- ➔ Provides you **50 days Study Planner** for each exams
- ➔ **Covers all types** of questions in each topic
- ➔ Questions in **Exact Exam Level**
- ➔ All Our PDFs are **Downloadable**
- ➔ **100% Satisfaction Assured** & It's Worthy for your money

English Language

Directions (1-5): In each of the following questions one word is highlighted in the bold, and using that word four sentences are framed. The word usage in three sentences is appropriate and in one sentence, word usage is inappropriate. You are required to find out the sentence in which the usage of the word is inappropriate.

1) Oblivion

- A. Since the garment factory opened, our **oblivion** town has sprung to life as a result of the new employment opportunities.
- B. During the virtual conference, the disgraced legislator pretended he was in **oblivion** to avoid answering difficult questions.
- C. The story put her in such a state of **oblivion** she forgot to prepare dinner for her family.
- D. Lalita let her accountant handle all of her business dealings; she was in **oblivion** when the Income Tax Officer asked her about tax fraud.
- E. None of the above

2) Myriad

- A. In the capital, there are **myriad** restaurants that will charge you several rupees for a tiny chocolate.
- B. The temple priest urged everyone to thank the deity for the **myriad** blessings in their lives.
- C. Anyone can postulate on the **myriad** regional and economic issues that are destroying our country.

D. The **myriad** helicopter will hover for 30 seconds, capture images, make a turn and return to the ground.

E. None of the above

3) Maverick

- A. As long as the company owner acts like a **maverick** by ignoring his colleagues, he will have no friends at his organization.
- B. My **maverick** sister has made her fortune by using a smart strategy different from that of her competitors.
- C. My daughter is an exercise **maverick** who runs five miles every day in order to lose weight.
- D. Because the **maverick** man had issues with his partner's decisions, he started a separate branch of the business.
- E. None of the above

4) Glut

- A. Because Rahul consumed a **glut** of food at the party; he now has a very bad stomach ache.
- B. Jaya took a **glut** of candies and left only a couple for everyone else at the home.
- C. The **glut** of cars for sale makes it a buyer's market.
- D. With a **glut** of electronic books on his phone, Shantanu will never run out of reading material.
- E. None of the above

5) Fealty

- A. When the prime minister took his oath, he swore **fealty** to serve the nation.

- B. The fighter maintained his **fealty** to his country even when he was being beaten by the enemy.
- C. Gandhi showed great **fealty** towards all the little creatures on the earth.
- D. The governor didn't believe his assistant manager was dedicated to his vision, so he fired him for his absence of **fealty**.
- E. None of the above

Directions (6-10): In each of the questions below there are two columns. In column I, a), b), c) are there and in column II, d), e), f) are there. In these two columns some words are also highlighted in bold which may or may not be wrongly spelt or inappropriate. You are required to replace the incorrect word and then match column I with column II in order to form a grammatically correct and contextually meaningful sentence.

6)

Column I	Column II
a) India's cotton and sugar sectors have welcomed the news of Pakistan finally allowing the import of yarn and 5 lakh tons of sugar from the country. This will help India explode the market and	d) Cotton mostly from USA and Brazil, although it takes longer for the raw material to transported from these countries. Pakistani textile manufacturers have been demanding that imports from India be allowed, as it would be a cheaper option for them.

b) Pakistan had stopped import of cotton and yarn from India after a political falloff over the abrogation of Article 370 in Kashmir. The move cut off the	e) Reduce carry over stock for the next season. In case the cotton exports go through, Indian cotton growers can expect to start their season with prices more than the government- declaration Minimum Support Price (MSP).
c) Pakistan domestically produces 50 lakh bales (each bale weighing 170 kg of ginned pressed cotton) of its annual demand of 1.5 crore bales. A major importer, Pakistan sources its	f) Access of Indian cotton ginners and yarn manufacturers to the neighboring market. Pakistan normally imports 4-5 lakh bales from India, but a draught and attack of locusts in the neighboring country has necessitated more imports.

- A. (b-fallin-d-reach),(c-domestically-f-drought)
- B. (a-exploring-f-drought),(b-fallon-d-transport),(c-domesticated-e-declared)
- C.(a-explore-e-declared),(b-fallout-f-drought),(c-domestically-d-transport)
- D.(a-exploring-e-declared),(b-fallin-f-drought)
- E. None of the above

7)

Column I	Column II
a) As per the latest government mandate, Delhi Disaster Management Authority shall conduct random Covid-19 testing of passengers coming from states where cases are increasing. After the collection of samples, the travellers would be allowed to exit.	d) in which senior citizens (above 60 years of age) and people aged 45 or older with comorbidities were eligible. One can register self for Covid-19 vaccination through the government's Co-Win portal
b) The Covid surge in Delhi has mainly affected the younger population with most of the patients reporting "relatively mild symptoms", according to AIIMS director Dr Randeep Guleria.	e) However, the passengers who are found to be positive shall be compulsory quarantined as per the Ministry of Health and Family Welfare protocol.
c) The vaccination drive was kicked off in January with healthcare workers and frontline workers getting incubated first. It was followed by the second phase	f) But there is a need to remain vigil , he said, because the infection can "spread to the elderly" and trigger "serious symptoms", which would once again put healthcare resources under strain.

- A. (a-passanger-f-vigilance),(b-milder-d-comorbidity)
- B. (a-passengers-e-mandatorily),(b-milder-f-vigilant),(c-inoculated-d-comorbidities)
- C. (a-travelers-e-compulsorily), (b-milder-d-comorbidities)
- D. (a-travellers-f-vigilant),(b-milder-e-compulsorily),(c-incubate-d-comorbidities)
- E. No correction require

8)

Column I	Column II
a) Mercedes-Benz India has recently issued advertisements appeasing to potential customers to bear with "a short waiting period" for vehicle deliveries. It's an unusual request for the German luxury carmaker — but it is not alone in asking customers to be patient.	d) A steadily decline in input prices and improvements in the processing power of chips. The number of transistors mounted in IC circuit chips has doubled every two years. This phenomenon, widely known as Moore's Law, meant smaller devices with greater processing speeds.
b) A common component across cars, electronic goods, medical devices, and smart appliances is the integrated circuits (IC) chip. ICs are the basis	e) Wait times for cars are currently among the longest in recent times, and a shortage of critical parts such as semiconductor chips are being sited

of all modern electrical equipment, and the chip is their brain and nerve centre.	as a key reason. Both global and Indian manufacturers have reported production issues linked to availability of chips, and been forced to apply brakes on production.
c) With just-in-time deleveries , carmakers typically kept low inventory holdings and relied on an electronics industry supply chain to feed production lines as per demand. There were two reasons for this	f) The circuit is essentially an aggregation of electronic components — resistors, transistors, capacitors — snuffed into a small silicon chip, and connected together to perform a single or multiple functions.

- A.(b-electronic-f-stuffed)(c-deliveries-d-steady)(a-appealing-e-cited)
- B.(c-delivery-f-snuffing) (a-appealing-e-citing)
- C. (a-appealing- f-stuffed) (c- deliveries-d-steady) (b-electronic-e-cited)
- D.(a-appeal-d-steady) (b- electronical- f-stuffing)
- E. None of the above

9)

Column I	Column II
a) In a boost to the sea tourism in Gujarat, Union Minister Mansukh Mandaviya virtually flagging off cruise services from Essar bulk terminal at Hazira in Surat to Diu, a union territory on the	b) to Saurashtra. By intra-linking all these coastal lines, we wanted to connect Mumbai, Surat and Saurashtra and give a boost to industrial development. We are also promoting private sector players and are ready to provide all necessary support.
b) We are working in the direction to develop coastal connectivities of Mumbai with Surat and Saurashtra, via ferry services, RoPax services and cruise services,	e) so that many people are benefited . The development of cruise tourism has been the prime focus of central government under the guidance of Prime Minister Narendra Modi
c) We want to make Surat a water transportation hub. We are also setting infrastructure for RoPax ferry services in Mumbai. Such infrastructure is already there in Surat, and we are also expanding it	f) Saurashtra coast, on Wednesday. The development of cruise tourism, Mandaviya said, has been the prime focus of the Narendra Modi government at the Center .

- A.(a-flaggedoff-f-centre),(c-extending-d-interlinking),(b-connectivity-e-benefitted)
 B.(a-flaggedoff-f-centre),(c-expand-d-interlinked),(b-connectivity-e-benefitted)
 C.(c-extend-d-interlinking),(b-connectivity-e-benefitting)
 D.(a-flaggedoff-f-central),(c-extending-d-interlinking),(b-connection-e-benefitting)
 E. No correction required

10)

Column I	Column II
a) A month after Chief Minister Captain Amarinder Singh announced the founding of an Enforcement Directorate (ED) to check illegal mining in Punjab, the Cabinet on Wednesday approved the move. The ED,	d) Prosecution of those indulging in illegal mining. Working closely with the mining wing of the water resources department, the ED will also ensure that those involved in sand and gravel business do not overcharge on the sale price ceiling described in the mining policy.
b) A government statement said the ED would help in checking and stopping unauthorized movement of minor minerals within the state and at the interstate borders of Punjab, in conjunction with the officials of the	e) Illegal mining enforcement committees under the deputy commissioners. It will also develop actionable intelligence for the purpose and coordinate with agencies of the neighboring states

mining department. It will also faciliate	dealing with the issue of illegal mining.
c) The ED will have the mandate to develop strategies, measures and methods to affectively achieve the objectives in coordination with the director mining, chief engineers dealing with mining and district level	f) To be headed by a senior police officer not below the rank of deputy inspector general of police (DIG), will be set up in the mining and geology wing of the water resources department. It will also help ramp up the state's revenues by curbing the manacing of illegal mining.

- A.(b-facilitating-d-prescribing),(a-establishing-f-menacing)
 B.(c-effective-e-commissioners),(b-facilitating-d-describing)
 C.(c-effectively-e-commissioners),(b-facilitate-f-menace),(a-establishment-d-prescribed)
 D.(c-effectively-e-commissioners),(b-facilitate-d-prescribed),(a-establishment-f-menace)
 E. No correction required

Directions (11-15): In each of the questions below some words from the sentence are highlighted in bold which may or may not be correct. You are required to find out which phrase should replace the phrase given in bold

in order to make the sentence grammatically correct and contextually correct.

11) The Supreme Court-appointed three-member committee on the farm reform laws has submitted its report on the contentious laws to the court in a sealed cover. The committee, in its report, **had said that over 85 farmer organizations have been consulting to find a solution in the deadlock with the protesting farmers who have been camping at the borders around Delhi for over 4 months.**

- A. have said that around 85 farmer organizations has been consulted for find a solution to the deadlock to the
- B. has said that around 85 farmer organizations have been consulted to find a solution on the deadlock with the
- C. had said that around 85 farmers organizations has been consulting to find a solution on the deadlock to the
- D. has been said that around 85 farmers organizations has been consulted to find a solution on the deadlock with the
- E. No correction required

12) Before the Covid-19 pandemic, about a trillion chips were being manufactured on average globally every year. That's about 120 chips per person — **which would seems like lot, considering only a small percentage of the global populations'uses high-end connected item contained many chips.** But the

chip shortage today has a lot to do with the pandemic — and how it changed consumer behavior.

- A. which would seem like a lot, considering only a small percentage of the global population uses high-end connected items containing many
- B. that would seems like lot, considered only small percentage of the global population use high-end connected item containing many
- C. which would seems like a lot, considering only a small percentage of the global population used high-ended connected items containing most
- D. which would seem like lot, considered only a small percentage of the global population using high-end connecting item contained many
- E. No correction required

13) In line with its reform measures, the Army on Wednesday disbanded its military farms after 132 years in service. **The flag ceremony of the closure of the facilities were held at Military Farms Records at Delhi Containment, officials said.** In August 2017, the defense ministry announced a series of reform measures for the Indian Army that included shutting down of the military farms, housing around 25,000 head of cattle, in the country.

- A. A flagging ceremony for the closing of the facilities was held in Military Farms Records at Delhi Cantonment, officials said.
- B. The flag ceremony of the closure of the facilities were held in Military Farms Records at Delhi containment, official said.

C. A flag ceremony for the closure of the facilities was held at Military Farms Records at Delhi Cantonment, officials said.

D. The flag ceremony for the closing of the facility was happened at Military Farms Records in Delhi Containment, officials said.

E. No correction required

14) West Bengal is heading towards severe outbreak of the second wave of corona virus as the people are not adhering on the protocols to check it's spread and large numbers of them are participating in innumerable rallies and campaigns by political leaders across the poll-bound state almost daily, city doctors fear.

A. is headed towards severed outbreak of the second waves of corona_virus as the people are not adhering to the protocols to check it's

B. is heading towards severe outbreak of the second wave of corona virus as the people doesn't adhered on the protocols to check it's

C. is headed towards severely outbreak of the second wave of corona virus as the people is not adhered to the protocol to check its

D. is heading towards severe outbreak of the second wave of corona virus as the people are not adhering to the protocol to check its

E. No correction required

15) The central government on Wednesday extended the deadline for linking Aadhaar number with permanent account number (PAN) to June 30, 2021. The earlier

deadline was March 31. The government has said those who missed the deadline will be liable to pay penalty of up to Rs 2,000 and their PAN will become invalid.

A. The government has said those who miss the deadline will liable to pay penalty of above

B. The government had said those who miss the deadline will be liable to pay a penalty of up to

C. The government had said those whom miss the deadline will liable to pay a penalty up to

D. The government has said those who miss the deadline will be reliable to pay a penalty of up to

E. No correction required

Directions (16-20): In each of the questions below one paragraph has been given and in options three-four sentences are also given based on the same theme but written in a different structure. You are required to find out the sentence(s) which infer the similar meaning as given in the paragraph given in bold.

16) Radha and her mother went to the zoo on Sunday evening, where both of them saw many wild animals and as soon as they saw the lion inside the cage, they ran away because the lion was roaring and that frightened them.

i) Radha with her mother went to the zoo on Sunday evening, where both of them saw many wild animals and no sooner did they see the lion inside the cage than they ran away because the lion was roaring and that made them frightened.

ii) Radha with her mother went to the zoo on Sunday evening, where both of them saw many wild animals, they saw the lion inside the cage

and at once they ran away because the lion was roaring and that made them frightened.

iii) Radha with her mother went to the zoo on Sunday evening, where both of them saw many wild animals and the moment they saw a lion inside the cage, they ran away because the roaring of the lion made them frightened.

- A. Only (i)
- B. Only (ii)
- C. Only (iii)
- D. Both (i) and (iii)
- E. All (i),(ii) and (iii)

17) Ram along with his wife Rama went to a car showroom to buy a brand new car that was launched last week; he wanted to purchase the car, notwithstanding her objections. According to Rama that car doesn't meet her requirements.

- i) Ram along with his wife Rama went to a car showroom to buy a brand new car that was launched last week, despite her objections he wanted to purchase the car. According to Rama that car doesn't meet her requirements.
 - ii) Ram along with his wife Rama went to a car showroom to buy a brand new car that was launched last week, because of her objections he wanted to buy the car. According to Rama that car doesn't meet her requirements.
 - iii) Ram along with his wife Rama went to a car showroom to buy a brand new car that was launched last week, in spite of her objections he still wanted to purchase the car. According to Rama that car doesn't meet her requirements.
- A. Only (i)

- B. Only (ii)
- C. Only (iii)
- D. Both (i) and (iii)
- E. All (i),(ii) and (iii)

18) A student from IIT Mumbai won the first prize in the International Quiz Competition held in Pune. When everyone asked the reason of success from his parents they told that their son is hard working and he is intelligent, the combination of these two makes him successful.

- i) A student from IIT Mumbai won the first prize in the International Quiz Competition held in Pune. When everyone asked the reason of success from his parents they told that besides being hard working he is intelligent and the combination of these two makes him successful.
 - ii) A student from IIT Mumbai won the first prize in the International Quiz Competition held in Pune. When everyone asked the reason of success from his parents they told that his son is not only hard working but also intelligent and the combination of these two makes him successful.
 - iii) A student from IIT Mumbai won the first prize in the International Quiz Competition held in Pune. When everyone asked the reason of success from his parents they told that his son is hard working while he is intelligent and the combination of these two makes him successful.
- A. Only (ii)
 - B. Both (i) and (ii)
 - C. Both (ii) and (iii)
 - D. Both (i) and (iii)
 - E. All (i),(ii) and (iii)

19) Jaya is a very naughty girl, she always makes fun of her classmates and annoys her teachers, one day she stole a 500 rupee note from her teacher's purse while doing this she was caught by the school Principal. He said to her that to avoid punishment, she must apologize.

i) Jaya is a very naughty girl, she always makes fun of her classmates and annoys her teachers, one day she stole a 500 rupee note from her teacher's purse while doing this she was caught by the school Principal. He said to her that either she must apologize, or you will be punished.

ii) Jaya is a very naughty girl, she always makes fun of her classmates and annoys her teachers, one day she stole a 500 rupee note from her teacher's purse while doing this she was caught by the school Principal. He said to her that you must apologize, yet you will be punished.

iii) Jaya is a very naughty girl, she always makes fun of her classmates and annoys her teachers, one day she stole a 500 rupee note from her teacher's purse while doing this she was caught by the school Principal. He said to her that she must apologize otherwise you will be punished.

- A. Only (ii)
- B. Both (i) and (ii)
- C. Both (i) and (iii)
- D. Both (ii) and (iii)
- E. All (i),(ii) and (iii)

20) In the new normal of social distancing and remote working, taking on healthy living is very

important. Enhancing your physical, mental and emotional well-being by consciously making small changes in your lifestyle, developing healthy habits and continuing with them is necessary.

i) In the new normal of social distancing and remote working, taking on healthy living is very important. In order to enhance your physical, mental and emotional well-being, consciously making small changes in your lifestyle, developing healthy habits and continuing with them is necessary.

ii) In the new normal of social distancing and remote working, taking on healthy living is very important. Meanwhile enhancing your physical, mental and emotional well-being by consciously making small changes in your lifestyle, developing healthy habits and continuing with them is necessary.

iii) In the new normal of social distancing and remote working, taking on healthy living is very important. Although enhancing your physical, mental and emotional well-being by consciously making small changes in your lifestyle, developing healthy habits and continuing with them is necessary.

- A. Only (i)
- B. Only (ii)
- C. Only (iii)
- D. Both (i) and (iii)
- E. All (i),(ii) and (iii)

[Click Here to Get the Detailed Video Solution for the above given Questions](#)

Or Scan the QR Code to Get the Detailed Video Solutions



Answer Key with Explanation

1) Answer: A

The sentence in which the usage of the word is inappropriate is A because “moribund” will be the correct word instead of “oblivion”.

Oblivion means the condition of being unaware or uninformed Moribund means (especially of an organization or business) not active or successful

2) Answer: D

The sentence in which the usage of the word is inappropriate is D because “miniscule” will be the correct word instead of “myriad”.

Myriad means of an indefinite large number
Miniscule means quite small

3) Answer: C

The sentence in which the usage of the word is inappropriate is C because “fanatic” will be the correct word instead of “maverick”.

Maverick means tending to choose a different path from everyone else

Fanatic means one who is extremely passionate about something

4) Answer: E

In all the four sentences usage of the word is appropriate, hence (E) is the correct answer
Glut means an amount in excess of what is normal or necessary

5) Answer: C

The sentence in which the usage of the word is inappropriate is C because “solicitude” will be the correct word instead of “fealty”.

Fealty means an official acknowledgment of loyalty
Solicitude means care or concern

6) Answer: C

The correct match is – (a-e) (b-f) and (c-d)

Misspelt word or inappropriate word

In a- Instead of “explode”, “explore” will be used
In b- Correct phrasal verb is “fallout” instead of “falloff”.

Fall out – having an argument

In c- Correct spelling of domestically is “domestically”

In d- Instead of “transported”, “transport” will be used

In e- Instead of “declaration”, “declared” will be used

In f- Here, draught is incorrect which means a current of cool air in a room or other confined space.

Correct word is “Drought” which means a long period when there is little or no rain

7) Answer: B

The correct match is – (a-e) (b-f) and (c-d)

Misspelt word or inappropriate word

In a- Correct spelling of pessangers is “passengers”

In b- Instead of “mild”, “milder” will be used

In c- “Incubated” is incorrect here, the correct word that will replace it, is “inoculated” which means treat with a vaccine to produce immunity against a disease; vaccinate.

In d- Correct spelling of comorbidity is “comorbidities”

In e- Compulsory will be replaced by “mandatorily”

In f- Instead of “vigil”, “vigilant” will be used

8) Answer: A

Correct Match is – (a-e) (b-f) and (c-d)

Misspelt word or inappropriate word

In a – Instead of “appeasing”, “appealing” will be used.

In b- We never use electrical equipment, we always use electronic equipment so Instead of “electrical”, “electronic” will be used.

In c- correct spelling of deliveries is “deliveries”

In d- Instead of “steadily”, “steady” will be used

In e- Instead of “sited”, “cited” will be used

In f- Snuffed is incorrect here so it will replace by “stuffed”

9) Answer: A

The correct match is – (a-f) (c-d) and (b-e)

Misspelt word or inappropriate word

In a- Flagging off will be replaced by “flagged off”

In b- Instead of “Connectivities”, “connectivity” will be used

In c- Expanding will be replaced by “extending”

In d- Intralinking will be replaced by “interlinking”

In e- Correct spelling of benefited is “benefitted”

In f- Instead of “center”, “centre” will be used

10) Answer: D

The correct match is (c-e) (b-d) and (a-f)

Misspelt word or inappropriate word

In a- Founding will be replaced by “establishment”

In b- Instead of “faciliate”, “facilitate” will be used

In c- Affectively will be replaced by “effectively”

In d- Described will be replaced by “prescribed”

In e- Correct spelling of commissioners is “commissioners”

In f- Correct word that will replace manacing is “menace” which means one that represents a threat

11) Answer: B

Correct sentence after phrasal replacement-

The Supreme Court-appointed three-member committee on the farm reform laws has submitted its report on the contentious laws to the court in a sealed cover. The committee, in its report, has said that around 85 farmer organizations have been consulted to find a solution on the deadlock with the protesting farmers who have been camping at the borders around Delhi for over 4 months.

12) Answer: A

Correct sentence after phrasal replacement-

Before the Covid-19 pandemic, about a trillion chips were being manufactured on average globally every year. That’s about 120 chips per person — which would seem like a lot, considering only a small percentage of the global population uses high-end connected items containing many chips. But the chip shortage today has a lot to do with the pandemic — and how it changed consumer behavior.

13) Answer: C

Correct sentence after phrasal replacement-

In line with its reform measures, the Army on Wednesday disbanded its military farms after 132 years in service. **A flag ceremony for the**

closure of the facilities was held at Military Farms Records at Delhi Cantonment, officials said. In August 2017, the defense ministry announced a series of reform measures for the Indian Army that included shutting down of the military farms, housing around 25,000 head of cattle, in the country.

14) Answer: D

Correct sentence after phrasal replacement-

West Bengal is heading towards severe outbreak of the second wave of corona virus as the people are not adhering to the protocol to check its spread and large numbers of them are participating in innumerable rallies and campaigns by political leaders across the poll-bound state almost daily, city doctors fear.

15) Answer: B

Correct sentence after phrasal replacement-

The central government on Wednesday extended the deadline for linking Aadhaar number with permanent account number (PAN) to June 30, 2021. The earlier deadline was March 31. **The government had said those who miss the deadline will be liable to pay a penalty of up to Rs 2,000 and their PAN will become invalid.**

16) Answer: E

All the three sentences can be framed without altering the meaning of the above given sentence

i) Sentence is framed using no sooner and the rule of no sooner is –it is used to show that one thing happens immediately after another thing. In such cases, it is often used with a verb in past perfect tense, and is usually followed by *than*.

ii) And (iii) Sentences are framed using at once and the moment, both of them depict the same meaning of the given sentence.

17) Answer: D

(i) And (iii) sentences can be framed without altering the meaning of the above given sentence.

Sentences are framed using despite and in spite of, they both are used to show contrast between two.

Sentence (ii) doesn't depict the same meaning of the given sentence

18) Answer: B

(i) And (ii) sentences can be framed without altering the meaning of the above given sentence.

Sentences are framed using besides and not only...but also, they both depict the same meaning of the given sentence

Sentence (iii) is incorrect because while is used and when we want to show contrast between two we use while.

19) Answer: C

(i) And (iii) sentences can be framed without altering the meaning of the above given sentence.

Sentences are framed using the conjunctions (either.....or, otherwise) they both depict the same meaning of the given sentence

Sentence (ii) is incorrect because yet is used.

20) Answer: A

Only (i) sentence can be framed without altering the meaning of the above given sentence.

Sentence is framed using in order to because it is used to express the purpose of something Sentences (ii) and (iii) are contextually incorrect and not able to express the same meaning.

The Hindu Editorial Vocabulary

1) Taunt (noun) – insult, provocation, teasing

Example: The demonstrators yelled foul chants to taunt the police officers.

Antonyms: Taunt x approval, praise, respect

2) Unseemly (adjective) –improper, indecorous, inappropriate

Example: Eating salad with your fingers is considered **unseemly** in most social environments.

Antonyms: Unseemly x becoming, fitting, proper

3) Catharsis (noun) –abreaction, cleansing, releasing

Example: Crying is a great **catharsis** for releasing pain and anger.

Antonyms: Catharsis x repression, adulteration, pollution

4) Infantile (adjective) –adolescent, young, infant

Example: I hate listening to that morning radio show because people call in with comments that are so **infantile** and immature

Antonyms: Infantile x mature, adult, developed

5) Ingrained (adjective) –constitutional, inherent, inborn

Example: The new teacher wanted her rules and procedures **ingrained** in her students in order to promote a smoothly run classroom.

Antonyms: Ingrained x extrinsic, acquired, incidental

6) Ostensible (adjective) –supposed, apparent, alleged

Example: This new archaeological discovery is an **ostensible** source of hundreds of valuable artifacts.

Antonyms: Ostensible x real, genuine, obscure

7) Ominous (adjective) – baleful, inauspicious, menacing

Example: The warning sounds of an **ominous** storm made us run for cover.

Antonyms: Ominous x cheerful, promising, bright

8) Malaise (noun) – infirmity, disease, illness

Example: Many citizens who live near the contaminated lake are complaining of a **malaise** that keeps them bedridden.

Antonyms: Malaise x comfort, ability, calmness

9) Hassle (noun) –argument, dispute, fight

Example: I started to get all this **hassle** from my boss about increasing productivity.

Antonyms: hassle x agreement, aid, calm

10) Resentment (noun) –bitterness, grudge, animosity

Example: Deep **resentment** existed between the two rival players who had hated each other for many years.

Antonyms: Resentment x happiness, contentment, affection

[Get Our Special Grand Bundle PDF Course for All Upcoming Bank Exams](#)

[Click Here to Get our Grand Bundle PDF Course to Access 40,000 Qus \(Eng+Hin\) with Video Solution](#)

Website:www.guidely.in | **Blog:**www.ibpsguide.com | **Email:**support@guidely.in

Dear Friends, this is the Special Paid Bundle PDF Course which was made because of the Hard work of Our Experts Team. This PDF Course consists of High-Standard Questions on Reasoning, Quants, English, Current Affairs Quiz, Static GK Quiz and Banking Awareness Quiz Exactly on Exam Level. Total 40,000 Questions and Course Duration is of 50 Days for each exam. If anyone got this PDF without purchasing it, kindly buy this PDF Officially using the link given below. This will encourage us to work harder to produce high quality content for you in upcoming days.

[Get Our Special Grand Bundle PDF Course for All Upcoming Bank Exams](#)

Grand Bundle PDF Course 2021

Exams Covered:

SBI Clerk | SBI PO | IBPS RRB PO |
IBPS RRB Clerk | IBPS PO | IBPS Clerk

Separate PDF Course for All Major **Bank Pre + Mains** Exams

- Total No. of Ques.: **40,000+**
- Question in Bilingual (**Eng & Hindi**)
- Answers With Detailed **Video Solution**
- Provides you **50 days Study Planner** for each exams
- **Covers all types** of questions in each topic
- Questions in **Exact Exam Level**
- All Our PDFs are **Downloadable**
- **100% Satisfaction Assured** & It's Worthy for your money

Current Affairs

1. The government has extended the deadline to file ITR for individuals to Jan 10, 2021. The late filing fees are only Rs 1,000 for those with taxable income up to Rs 5 lakh and those required to file returns under the _____ proviso of Section 139(1) of the Income-tax Act.

- A) 7th
- B) 8th
- C) 9th
- D) 10th
- E) 11th

Answer: A

The government extended the deadline to file income tax return (ITR) for individuals by 10 days to January 10, 2021. Prior to that, the deadline was December 31, 2020. This is the third time that the government has extended the deadline to file ITR first from the normal deadline of July 31 to November 30, 2020, and then to December 31, 2020.

The last date for filing ITR has been extended for those taxpayers whose filings using ITR-1 and ITR-4 forms are not required to be audited.

Further, this year, if the ITR was not filed by the earlier deadline December 31, then the penalty or late filing fees levied for filing a belated ITR would have been twice that payable the previous year.

It is to be noted that late filing fees or penalty are only Rs 1,000 for those with taxable income up to Rs 5 lakh and those required to file returns under the seventh proviso of Section 139(1) of the Income-tax Act.

Under this newly inserted seventh proviso of section 139 of the Income-tax Act, ITR filing is mandatory in the following cases:

- A) If you have deposited Rs 1 crore or more in one or more current accounts maintained with a bank or co-operative bank;
- B) If you have spent Rs 2 lakh or more on foreign travel on self or any other person in the relevant financial year; and
- C) If you have paid an electricity bill of Rs 1 lakh or more in the relevant FY

2. The Central government has recently launched INSACOG to monitor the genomic variations in the SARS-CoV-2 on a regular basis through a multi-laboratory network. INSACOG was formed under the leadership of which among the following?

- A) Indian Council of Medical Research (ICMR), New Delhi.
- B) Council of Scientific and Industrial Research (CSIR), New Delhi
- C) NITI Aayog, New Delhi
- D) Serum Institute of India, Maharashtra
- E) National Centre for Disease Control (NCDC), New Delhi.

Answer: E

The Central government has formed a genomic surveillance consortium for laboratory and epidemiological surveillance of circulating strains of the SARS-CoV-2 in India.

The Indian SARS-CoV-2 Genomic Consortia (INSACOG) has been launched. Coordinated by ²

the Department of Biotechnology (DBT) along with MoH&FW, ICMR, and CSIR, the strategy and roadmap of the National SARS CoV2 Genome Sequencing Consortium (INSACOG) have been prepared.

The genomic surveillance consortium, INSACOG, has been formed under the leadership of the National Centre for Disease Control (NCDC), New Delhi.

3. On the recommendation of which committee, the Department of Commerce has notified the rates of Remission of Duties and Taxes on Exported Products (RoDTEP) to all export goods?

- A) Kasthuri Rangan
- B) Sunil Mehta
- C) G.K Pillai
- D) Sanjiv Puri
- E) R S Sharma

Answer: C

The Government has decided to extend the benefit of the scheme for the Remission of Duties and Taxes on Exported Products (RoDTEP) to all export goods to boost exports. The RoDTEP rates were notified shortly by the Department of Commerce, based on the recommendation of a committee chaired by former Commerce and Home Secretary Dr. G.K. Pillai

4. The BPR&D released the Data on Police Organizations in Jan '21. Generally, who

released the Data on Police Organization as of 01.01.2019?

- A) Amit Shah
- B) Rajnath Singh
- C) Narendra Modi
- D) Jitendra Singh
- E) Ramnath Kovind

Answer: A

The Bureau of Police Research & Development (BPR&D) released Data on Police Organizations. The BPR&D has been publishing the Data on Police Organizations (DoPO), annually, since the year 1986.

DoPO as of 01.01.2019 was released by the Union Home Minister Shri Amit Shah, on 29th January 2020. This is for the first time in the history of BPR&D that DoPO for a particular year has been released during the year itself.

5. . Home Minister Amit Shah recently has released the National Police K-9 Journal in New Delhi. It is a biannual Journal released every year in which two months?

- A) April and December
- B) January and July
- C) March and November
- D) April and October
- E) June and October

Answer: D

Home Minister Amit Shah released the inaugural issue of the National Police K-9 Journal in New Delhi.

It is the first such publication in the country on the subject of Police Service K9s, Police Dogs.

The journal comprises different sections in Hindi and English.

It is a biannual journal that will be released in April and October every year.

6. Union Cabinet has approved the Multi-Modal Logistics Hub & Multi-Modal Transport Hub (MMTH) at Greater Noida. The Proposal for the construction was made by whom?

- A) NITI Aayog
- B) Invest India
- C) DPIIT
- D) NRDC
- E) CSIR

Answer: C

The government approved a multi-modal logistics and transport hub (MMTH) at Greater Noida in Uttar Pradesh.

The Union Cabinet also approved a proposal to set up industrial corridor nodes at Krishnapatnam and Tumakuru under CBIC.

The proposals have a total estimated cost of Rs 7,725 crore. The Union Cabinet has approved proposals of the Department of Promotion of Industry & Internal Trade (DPIIT) for construction of various tank infrastructure components, which includes: Krishnapatnam Industrial Area in Andhra Pradesh (estimated cost of the project of Rs. 2,139.44 crore) Tumakuru Industrial Area in Karnataka (estimated cost of Rs. 1,701.81 crore) Multi-Modal Logistics Hub (MMLH) and Multi-Modal Transport Hub (MMTH) at Greater Noida in Uttar Pradesh (estimated cost of Rs. 3,883.80 crore)

7. Bharat Electronics Limited has signed a contract with the Indian Navy for the initial supply of Light Amplification by Stimulated Emission of Radiation Dazzlers in New Delhi. How many Laser dazzlers were contracted to supply initially?

- A) 24
- B) 20
- C) 21
- D) 30
- E) 22

Answer: B

Bharat Electronics Limited (BEL) has signed a contract with the Indian Navy for initially supplying 20 Light Amplification by Stimulated Emission of Radiation Dazzlers (Laser Dazzlers) in New Delhi.

The BEL had earlier this month won the contract beating global Original Equipment Manufacturers (OEMs) in the global category.

These would be manufactured by BEL, Pune plant. Laser dazzler technology was developed by Defence Research and Development Organization (DRDO).

8. Prime Minister has inaugurated the National Metrology Conclave 2021 through video conferencing. What is the theme of National Metrology Conclave 2021?

- A) Meteorology for the Inclusive Growth of the Nation
- B) Metrology and Climatic Changes
- C) Inclusive growth is in Metrology
- D) Growth of atmosphere in Metrology

E) Metrology and Weather

Answer: A

Prime Minister inaugurated National Metrology Conclave 2021 through video conferencing.

National Metrology Conclave 2021 was organised by the Council of Scientific and Industrial Research National Physical Laboratory, New Delhi.

Science and Technology Minister Dr. Harsh Vardhan and Director General, CSIR, Shekhar Mande and Principal Scientific Adviser to the Central Government, Professor K VijayRaghavan was also present on the occasion. The theme of 2021: Meteorology for the Inclusive Growth of the Nation.

9. Dr. Harsh Vardhan digitally inaugurated the 7th NHM National Summit on Good, Replicable Practices through a video conference. He has launched the Operational guidelines for which of the following diseases?

- A) TB & HIV
- B) TB & Leprosy
- C) Anemia & Pneumonia
- D) Leprosy & HIV
- E) HIV & Anemia

Answer: B

Harsh Vardhan, Union Minister of Health and Family Welfare digitally inaugurated the 7th National Summit on Good, Replicable Practices through a video conference. Vardhan also launched New Health Management Information System (HMIS) along with the Operational Guidelines for TB services at AB-

HWCs and the Operational Guidelines 2020 on Active Case Detection and Regular Surveillance for Leprosy. While the first one was held in 2013 at Srinagar.

10. The foundation stone of Light House projects under Global Housing Technology Challenge (GHTC) at six sites across six States, has been laid by _____.

- A) Ramnath Govind
- B) Narendra Modi
- C) Amit shah
- D) Hardeep Singh puri
- E) Ravi Shankar Prasad

Answer: B

On 1st January Prime Minister Narendra Modi laid the foundation stone of Light House projects (LHPs) under the Global Housing Technology Challenge (GHTC)- at six sites across six States, through video conference. The projects are being undertaken under the Global Housing Technology Challenge (GHTC).

11. India begins its two-year tenure as a non-permanent member of the United Nations Security Council (UNSC). Presently, How many total non-permanent members are in the UNSC?

- A) 15
- B) 10
- C) 25
- D) 20
- E) 12

Answer: B

Solution: India will begin its two-year tenure as a non-permanent member of the United Nations Security Council (UNSC). India will sit in the 15-nation UNSC for the 2021-22 term as a non-permanent member — the eighth time that the country has had a seat on the powerful horseshoe table. On January 1, India, Norway, Kenya, Ireland and Mexico will join non-permanent members Estonia, Niger, Saint Vincent and the Grenadines, Tunisia and Vietnam and the five permanent members China, France, Russia, U.K. and the U.S.

12. India Post expects to make the Post Office Savings Bank interoperable with other bank accounts by April 2021. Who is the Secretary of the Department of Posts?

- A) Akshay Kumar Jain
- B) Prathiksha Patel
- C) Arun Kumar Sharma
- D) Pradipta Kumar Bisoi
- E) Pradeep Kumar Patil

Answer: D

India Post expects to make the Post Office Savings Bank interoperable with other bank accounts by April 2021.

Department of Posts Secretary Pradipta Kumar Bisoi said that The postal department during the lockdown was at the frontline to deliver essential parcels when rail, road and air traffic were grounded and continues to enhance capacity as trains are not fully operational yet.

13. After consultation with the 4 Chief Justice of India, Chief Justices/ Judges of High Courts have been transferred as per clause (1) of Article 222 of the Constitution of India. Who has the authorization to transfer the Justices/ Judges of High Courts?

- A) President
- B) Vice President
- C) Prime Minister
- D) Supreme court Chief Judge
- E) Home Minister

Answer: A

The President of India in the exercise of the power conferred by clause (1) of Article 222 of the Constitution of India, and after consultation with the 4 Chief Justice of India, transferred the Chief Justices/ Judges of High Courts. Recently 4 Chief Justices and 6 judges of High Courts are transferred by President after the consultation with the Chief /justice of India.

14. The Food Safety and Standards Authority of India (FSSAI) has capped the amount of trans fatty acids (TFA) in oils and fats to _____ for 2021.

- A) 2%
- B) 2.5%
- C) 3%
- D) 1.5%
- E) 3.5%

Answer: C

The Food Safety and Standards Authority of India (FSSAI) has capped the amount of trans fatty acids (TFA) in oils and fats to 3% for 2021

and 2% by 2022 from the current permissible limit of 5%.

The step to reduce trans-fat came after the World Health Organization (WHO) called for the global elimination of Trans fats by 2023.

Chairperson: Rita Teatota.

Primary Tag: National

Secondary Tag: In-depth

15. The 51st International Film Festival of India (IFFI) has opened in January '21. 'Another Round' was the opening movie of the festival.

This movie belongs to _____

- A) Norway
- B) South Korea
- C) Denmark
- D) North Korea
- E) England

Answer: C

Denmark's Oscar nominee 'Another Round' was opening movie at 51st IFFI in Goa.

The 51st International Film Festival of India (IFFI) opened with the Indian premiere of the movie 'Another Round' by Thomas Vinterberg.

The movie starring Cannes Best Actor Award winner Mads Mikkelsen is among a star-studded lineup of movies being showcased at IFFI.

The movie is also Denmark's official entry to the Oscars. The Japanese film bagged Silver Lion for Best Director at Venice International Film Festival.

16. Bajaj Auto has become the first two-wheeler company in the world to cross a market

capitalization of Rs 1 lakh crore. Where is the headquarters of Bajaj Auto located?

- A) Pune
- B) Ahmadabad
- C) Chennai
- D) Mumbai
- E) Kolkata

Answer: A

Bajaj Auto has become the first two-wheeler company in the world to cross a market capitalization of Rs 1 lakh crore, making it the most valuable two-wheeler maker. Bajaj Auto is India's largest exporter of two-wheelers and three-wheelers.

Headquarters: Pune, Maharashtra

Managing Directors: Rajiv Bajaj

17. The Journalist Day was observed on January 6 in memory of late journalist Balshastri Jambhekar. This day was observed by the people of which of the following states?

- A) Maharashtra
- B) West Bengal
- C) Gujarat
- D) Odisha
- E) Haryana

Answer: A

The Journalist Day is observed by the Maharashtra state government on 6th January every year. This day was celebrated in memory of late journalist Balshastri Jambhekar.

18. A Bank announced the launch of a video KYC account opening facility for savings bank

accounts. This bank has already launched a mobile banking application “I-Quick”, which allows its customers to avail themselves a multiple ranges of services. Name the Bank.

- A) ICICI Bank
- B) Yes Bank
- C) Canara bank
- D) IDBI Bank
- E) RBL Bank

Answer: D

IDBI Bank announced the launch of a video KYC account opening (VAO) facility for savings bank accounts.

IDBI Bank has already launched its mobile banking application “I-Quick”, which allows its customers to avail themselves a range of services such as funds transfer, bill payment, mobile/DTH recharge, and an account view across savings, current account, fixed/recurring deposits, loans and Demat.

19. World Bank has signed a \$105 million project to improve waterways in West Bengal. The Project will facilitate passenger and freight movement across which of the following river in West Bengal?

- A) Hooghly
- B) Damodar
- C) Jamuna
- D) Mahananda
- E) Padma

Answer: A

The Government of India and the Government of West Bengal and the World Bank signed a \$105

million project to improve the inland water transport infrastructure in Kolkata, West Bengal. The \$105 million loan from the International Bank for Reconstruction and Development (IBRD), has a maturity of 17 years, including a grace period of 7 years.

The West Bengal Inland Water Transport, Logistics and Spatial Development Project will facilitate passenger and freight movement across the Hooghly River.

20. The All India Gem and Jewellery Domestic Council (GJC) has been appointed _____ as the vice-chairman of the apex body.

- A) Ashish Pethe
- B) Sukumar Sen
- C) C.R.Chaudhary
- D) Saiyam Mehra
- E) Om Prakash Rawat

Answer: D

The All India Gem and Jewellery Domestic Council (GJC), the national apex body of the gems and jewellery industry, has announced the appointment of Ashish Pethe as chairman and Saiyam Mehra as vice chairman for two years.

21. The Centre has decided to form a committee to protect the language, culture and land of Ladakh and ensure citizen's participation in the Union Territory's development. The Committee was headed by whom?

- A) Hardeep Singh Puri
- B) G Kishan Reddy
- C) Amit Shah

- D) Jitendra Singh
E) Prahlad Joshi

Answer: B

The Centre has decided to form a committee to protect the language, culture and land of Ladakh and ensure citizen's participation in the Union Territory's development.

The Committee would be headed by the Minister of State for Home G Kishan Reddy and will include elected representatives from Ladakh, Ladakh Autonomous Hill Development Council, central government, and the Ladakh administration.

Union Home Minister Amit Shah met a 10-member delegation from Ladakh who expressed their views about the need to protect Ladakh's unique cultural identity.

22. Prime Minister Narendra Modi has inaugurated the New Rewari-New Madar section of the Western Dedicated Freight Corridor (WDFC). What is the total distance covered (approximately) by the project?

- A) 306 Km
B) 300 Km
C) 305 Km
D) 301 Km
E) 310 Km

Answer: A

Prime Minister Narendra Modi has inaugurated the 306-km New Rewari-New Madar section of the Western Dedicated Freight Corridor (WDFC). The Rewari-Madar section is situated in Haryana, approximately 79km in Mahendragarh

and Rewari districts and Rajasthan approximately 227km, in Jaipur, Ajmer, Sikar, Nagaur and Alwar districts.

23. Prime Minister Narendra Modi held a video teleconference with his German counterpart Federal Chancellor Angela Merkel. This year marks ____ anniversary of setting up bilateral relations between India and Germany.

- A) 75
B) 55
C) 80
D) 85
E) 70

Answer: E

Prime Minister Narendra Modi held a video-teleconference with his German counterpart Federal Chancellor Angela Merkel.

This year marks the 70th anniversary of setting up bilateral relations between India and Germany and the 20th anniversary of the Strategic Partnership, the two leaders agreed to hold the sixth Inter-Governmental Consultations at an early date in 2021 and to set an ambitious agenda for the same.

24. The Indian Meteorological Department (IMD) recorded the year 2020 as _____ warmest year since 1901.

- A) 5th
B) 8th
C) 11th
D) 7th
E) 10th

Answer: B

The year 2020 was the eighth warmest year on record since nation-wide records commenced in 1901, the India Meteorological Department (IMD).

However, the past year was substantially lower than the highest warming recorded in 2016. As per the IMD, the five warmest years on record in order were 2016, 2009, 2017, 2010 and 2015.

25. A new approach for surveying using satellite imagery and artificial intelligence (AI) could help in solving some of the present challenges in the conservation of the species. This Survey is going to be implemented for which of the following species?

- A) Asiatic Lion
- B) White Tiger
- C) Chimpanzee
- D) African elephants
- E) One-horned Rhino

Answer: D

A new approach for surveying African elephants using satellite imagery and artificial intelligence (AI) could help in solving some of the present challenges in the conservation of the species.

The survey method was developed by an international team of researchers led by the University of Oxford.

26. SBI Mutual Fund has acquired an additional 86,993 shares in CSB Bank Ltd (formerly The Catholic Syrian Bank Ltd), which raised its stake in the bank to _____ from 4.96% earlier.

- A) 5.01%
- B) 5.00%
- C) 5.05%
- D) 5.10%
- E) 5.03%

Answer: A

SBI Mutual Fund has acquired an additional 86,993 shares in CSB Bank Ltd (formerly The Catholic Syrian Bank Ltd), which consequently raised its stake in the bank to 5.01% from 4.96% earlier. The acquisition was made through open market purchase.

It is currently the oldest private sector bank in Kerala. In 1969 it became a Scheduled Bank, as it was included in the Second Schedule of Reserve Bank of India Act, 1934.

27. TRIFED & Akhil Bhartiya Vanvasi Kalyan Ashram signed a Memorandum of Understanding (MoU) to establish TRIFOOD Parks in how many districts of Madhya Pradesh?

- A) 10
- B) 11
- C) 6
- D) 3
- E) 5

Answer: E

TRIFED (Tribal Cooperative Marketing Development Federation of India Limited) under the Ministry of Tribal Affairs (MoTA) & Akhil Bhartiya Vanvasi Kalyan Ashram signed a Memorandum of Understanding (MoU) to establish TRIFOOD Parks in 5 districts in Madhya Pradesh.

The agreement was signed by Pravir Krishna, Managing Director (MD), TRIFED & Yogesh Bapat, and General Secretary of Akhil Bhartiya Vanvasi Ashram. The main aim of TRIFOOD is to enhance the income of tribal through optimal utilization of value addition to Minor Forest Produces (MFPs) collected by Tribal Forest Gatherers

28. Admiral Karambir Singh, the Chief of the Naval Staff has visited _____, Indian Navy's forward operating base at Okha, Gujarat.

- A) INS Sinduvir
- B) INS Darshak
- C) INS Dwarka
- D) INS Dhruv
- E) INS Shivalik

Answer: C

Admiral Karambir Singh, the Chief of the Naval Staff (CNS) visited INS Dwarka, Indian Navy's forward operating base at Okha, Gujarat, on New Year's Eve.

29. 'LUKOSIN' Developer and Senior scientist Hemant Kumar Pandey has been honoured with DRDO's 'Scientist of the Year Award'. LUKOSIN is _____ based company.

- A) Cosmetics Company
- B) Food based Company
- C) Mineral based Company
- D) Medicines based Company
- E) Hardware Company

Answer: D

'LUKOSIN' Developer and Senior scientist Hemant Kumar Pandey has been honoured with DRDO's 'Scientist of the Year Award' for his contribution in developing several herbal medicines, including the popular drug Lukoskin meant for the treatment of leucoderma.

30. BEML has received orders from MoD to supply the High-Mobility Vehicles to Indian Army within 1 year. Which BEML Plant has received the order?

- A) Mysore Complex
- B) Vignyan Industries Limited
- C) Bangalore Complex
- D) Palakkad Complex
- E) Kolar Gold Fields (KGF) Complex

Answer: D

BEML Ltd (previously known as Bharat Earth Movers Limited) has received orders worth ~ INR 758 crores from the Ministry of Defense (MoD) for supplying high-mobility vehicles to the Indian army.

The equipment would be manufactured at BEML's Palakkad Plant in Kerala and will be supplied to the Indian Army in a period of 1 year. The vehicles will play a vital role in the logistics management of the army.

31. Delhi Government Department of Art, Culture, and Language has set up a Tamil Academy in Delhi. The Delhi government has appointed _____ as the vice Chairman of the academy.

- A) P Chidambaram

- B) N Raja
- C) R Mani
- D) G Jawahar
- E) R Rakesh

Answer: B

Delhi Government Department of Art, Culture, and Language has set up a Tamil Academy to promote the language and culture of the southern state of Tamil Nadu.

The Delhi government has appointed a former municipal councilor and current member of Delhi Tamil Sangam N Raja as the vice-chairman of the academy.

32. The National Capital Region Transport Corporation (NCRTC) would use indigenously designed ballastless tracks for the country's first RRTS. RRTS stands for:

- A) Regional Rapid Transport System
- B) Regional Rapid Transit System
- C) Regional Rapid Tracking System
- D) Regional Rapid Turn System
- E) Regional Rapid Turning System

Answer: B

The National Capital Region Transport Corporation (NCRTC) will use indigenously designed ballastless tracks for the country's first Regional Rapid Transit System (RRTS).

As RRTS technology supports high-speed trains therefore these tracks will be suitable for high-speed trains running up to 180 kmph and require low maintenance.

Track slabs will first be used on the 17-km-long Sahibabad-Duhai priority section of the Delhi-Ghaziabad Meerut RRTS corridor.

The section will be operational by 2023; while the entire 82-km-long corridor will be completed by 2025. Tracks will be manufactured indigenously in a unit, currently being constructed in Meerut.

33. Dr. Raghu Ram Pillarisetti has been honoured with 'OBE-Officer of the Most Excellent Order of the British Empire' in Queen Elizabeth II's 2021 New Year's Honours list. Dr. Raghu Ram is a founder and CEO of _____

- A) Ushalakshmi Breast Cancer Foundation
- B) Poorna sudha cancer Foundation
- C) Shri Shankara cancer Foundation
- D) Shyam Oncology Foundation
- E) Karunakare foundation

Answer: A

India's Dr. Raghu Ram Pillarisetti (54 years old), Director and Consultant Breast Surgeon, KIMS-USHALAKSHMI Centre for Breast Diseases has been honoured with 'OBE-Officer of the Most Excellent Order of the British Empire' in Queen Elizabeth II's 2021 New Year's Honours list.

This second highest ranking Order of the British Empire award (excluding a knighthood/ dame hood) conferred to him in recognition of his outstanding services to Breast Cancer care and Surgical Education in India and UK/India relations. The award was instituted in 1917 by King George V.

34. Khadi and Village Industries Commission (KVIC) has signed an MoU with Indo-Tibetan Border Police for the supply of 1,72, 000 cotton durries every year. Who is the chairman of KVIC?

- A) Vinoth Kumar Sharma
- B) Vijay Kumar Saxena
- C) Varun Kumar Sharma
- D) Vinai Kumar Saxena
- E) ViduyutKumar Sharma

Answer: D

Khadi and Village Industries Commission signed MoU with Indo-Tibetan Border Police, ITBP for the supply of 1,72,000 cotton durries every year. The total value of these durries is eight crore 74 lakh. The development comes after Home Minister Amit Shah gave instructions to the paramilitary forces to encourage local products to support the AtmaNirbhar Bharat Abhiyan. KVIC Chairman Vinai Kumar Saxena termed the development as “historic” saying this would not only encourage the use of Swadeshi products in our forces but also create large-scale additional employment for Khadi artisans.

35. Lt Gen Shantanu Dayal has been named the new Deputy Chief of Army Staff. Lt Gen Dayal is the Corps Commander of the _____ based 4 Corps.

- A) Kanpur
- B) Solapur
- C) Jabalpur
- D) Sonapur
- E) Tejpur

Answer: E

Lt Gen Shantanu Dayal has been named the new DCOAS. Lt Gen Dayal is the Corps Commander of the Tejpur based 4 Corps. He takes place of Lt Gen SS Hasabnis who superannuated on December 31 as soon as his replacement arrives. Lt Gen Taranjit Singh, the first Army officer to join as the Additional Secretary in the Department of Military Affairs (DMA) under the Ministry of Defence.

36. The World Bank has projected _____% economic growth rate for Bangladesh for the FY 2020-21.

- A) 1.9 %
- B) 1.5 %
- C) 1.3 %
- D) 2.0 %
- E) 1.6 %

Answer: E

The World Bank has projected an economic growth rate of 1.6 percent for Bangladesh for the FY 2020-21. In its latest report on Global Economic Prospects released, the Bank has noted that the world economy is likely to grow by 4 percent in 2021.

This report points out that in Bangladesh, which had been one of the fastest growing emerging market and developing economies prior to the pandemic, growth is estimated to have decelerated to 2% in FY 2019/20.

The World Bank has estimated India’s GDP (Gross Domestic Product) growth to be in the range of 7.5 to 12.5 per cent during FY 2021-22

(FY 22). For the fiscal year 2020-21 ending on Wednesday, GDP contraction is estimated at 8.5 per cent as against a growth of 4 per cent during FY 2019-20.

37. Alex Ellis was appointed as a new British high commissioner to India. Alex Ellis succeeded whom for this post?

- A) Sir Richard Stagg
- B) Sir Rob Young
- C) Sir Dominic Asquith
- D) Sir Philip Barton
- E) Sir James Bevan

Answer: D

Alex Ellis, a British strategic expert, has taken charge as the new UK High Commissioner to India.

The 53-year-old civil servant has been serving as Deputy National Security Adviser in the UK Cabinet Office for the government's Integrated Review on diplomacy, development and defense. He succeeded Sir Philip Barton.

38. The Reserve Bank of India (RBI) has decided to introduce the Legal Entity Identifier (LEI) system for all payment transactions of value 50 crore and above undertaken by entities (non-individuals) via RTGS and NEFT. How Many digits do LEI consist of?

- A) 10
- B) 20
- C) 15
- D) 9
- E) 11

Answer: B

The Reserve Bank of India (RBI) has decided to introduce the Legal Entity Identifier (LEI) system for all payment transactions of value ₹ 50 crore and above undertaken by entities (non-individuals) via RTGS and NEFT.

Real-Time Gross Settlement (RTGS) and National Electronic Funds Transfer (NEFT) are the Centralized Payment Systems operated by RBI.

This will come into effect from April 01, 2021

39. The CCEA has approved a modified scheme to enhance ethanol distillation capacity in the country for producing 1G ethanol from feedstocks. India will need about 1,000 crore liters of ethanol for doping in petrol by _____.

- A) 2030
- B) 2035
- C) 2040
- D) 2022
- E) 2025

Answer: A

The CCEA has approved a modified scheme to enhance ethanol distillation capacity in the country for producing 1st Generation, 1G ethanol from feedstocks such as cereals like rice, wheat, barley, corn and sorghum and sugarcane, sugar beet etc.

An interest subvention of Rs 4,573 crore will also be provided for the production of ethanol, which can be used for doping in petrol. India will need about 1,000 crore liters of ethanol for doping in petrol by 2030 to cut dependency on imports for

meeting oil needs. The nation currently has a capacity of 684 crore liters.

40. The Cabinet Approved the Export of the Akash Missile System and Created a Committee for faster approval of Exports worth \$5 billion by 2024. Akash is a _____ Missile.

- A) Air-to-air
- B) Air-to-surface
- C) Antitank
- D) Surface-to-air
- E) surface-to-surface

Answer: D

The Union Cabinet also gave its approval to the sale of Akash surface-to-air missile systems to friendly foreign countries.

It created a high-powered Committee comprising Defence Minister (Rajnath Singh), External Affairs Minister (Subrahmanyam Jaishankar) and National Security Advisor-NSA (Ajit Kumar Doval) to provide faster approvals for export of such platforms.

Notably, the Government of India targets defence exports worth \$5 billion by 2024. Akash is a Surface to Air Missile with a range of 25 Kms. The missile was inducted in 2014 in IAF and in 2015 in Indian Army.

41. The PM gave away annual PMAY -Urban Awards-2019 for excellence in six categories for the implementation of PMAY-U. Which state has awarded in the Best Performing State category for the implementation of PMAY-U?

- A) Uttar Pradesh

- B) Bihar
- C) Andhra Pradesh
- D) Madhya Pradesh
- E) Arunachal Pradesh

Answer: A

The PM gave away annual “Pradhan Mantri Awas Yojana (Urban) Awards-2019” for excellence in six categories for the implementation of PMAY-U. Best Performing State-Uttar Pradesh (UP) followed by Madhya Pradesh (MP) and Andhra Pradesh (AP)

42. RBI Launched Jan 2021 Round of “Consumer Confidence Survey” & “Inflation Expectations Survey of Households”. How many cities are covered in the Inflation Expectations Survey of Households?

- A) 18
- B) 20
- C) 27
- D) 15
- E) 22

Answer: A

The Reserve Bank of India (RBI) launched the January 2021 round of household surveys namely “Inflation Expectations Survey of Households (IESH)” and “Consumer Confidence Survey (CCS)” to represent inflation expectations and consumer confidence.

This survey covers 6000 households across 18 cities by capturing subjective assessments i.e. qualitative and quantitative responses on price movements and inflation as per the individual’s consumption in the three-month ahead as well as

one-year ahead periods. The 18 cities are Ahmedabad, Bengaluru, Bhopal, Bhubaneswar, Chandigarh, Chennai, Delhi, Guwahati, Hyderabad, Jaipur, Kolkata, Lucknow, Mumbai, Nagpur, Patna, Raipur, Ranchi and Thiruvananthapuram.

43. Dr. Harsh Vardhan released a Book titled “Metrology for Inclusive Growth of India”. This book was edited by whom?

- A) Rasana Atreya
- B) Varsha Naik
- C) D.K. Aswaland
- D) Harika Bantupalli
- E) Tara Khandelwal

Answer: C

Dr. Harsh Vardhan released a Book titled “Metrology for Inclusive Growth of India”, edited by Dr. D.K. Aswaland contributed by CSIR-NPL’s Scientists. This book signifies the role of metrology for inclusive growth in India and describes various metrological applications. He also released a “Thesaurus of NPL” on the occasion.

44. John Fulton (F) Reid, former New Zealand cricketer passed away recently. The name of New Zealand national cricket team is nicknamed as_____.

- A) Red cap
- B) Blue cap
- C) Purple cap
- D) Black cap
- E) White cap

Answer: D

John Fulton(F) Reid, former New Zealand cricketer passed away at the age of 64 after a long illness at Christchurch, City in the South Island, New Zealand.

The Left-handed batsman was born on March 3, 1956 in Auckland, City in the North Island, New Zealand. He served as the New Zealand Test captain. The name of New Zealand national cricket team is nicknamed as Blackcap.

45. What is the Interest Rates for Small Savings Schemes for PPF according to the recently announced interest rate for Q4 2020-21?

- A) 7.0%
- B) 6.9%
- C) 7.2%
- D) 7.5%
- E) 7.1%

Answer: E

The finance ministry notified that the interest rates on small savings schemes including Public Provident Fund (PPF) and National Savings Certificate (NSC) for 4th quarter of 2020-21 (January 1 to March 31, 2021) will remain unchanged from those notified for the third quarter (October 1-December 31, 2020).

Scheme	Interest Rate
Public Provident Fund	7.1%
National Savings Certificate	6.8%
Savings Deposit	4%
Five-year Senior Citizens Savings	7.4% (Paid Quarterely)

Scheme	
Sukanya Samridhi Yojana	7.6%
Term deposits of 1-5 years	5.5 – 6.7% (Paid Quarterely)
5 – year recurring Deposit	5.8%
Kisan Vikas Patra	6.9%

46. Harmony Foundation hosted the Mother Teresa Memorial Awards. This award was given to which of the following field?

- A) Social Justice
- B) Art & Culture
- C) Sports
- D) Journalist
- E) Business

Answer: A

Harmony Foundation hosted the Mother Teresa Memorial Awards for Social Justice. The Awards in its 16th year is the only award endorsed by Sister Prema, the Superior General of the Missionaries of Charity, the organization started by Mother Teresa. The theme for awards was, Celebrating Compassion in Times of Covid.

47. A person referred as “Lone Wolf” has replaced Ambani as Asia’s richest person, Name the Person who is one of the fastest in history to achieve the feat.

- A) Colin Huang
- B) Goh Cheng Liang
- C) Zhang Zhidong
- D) Jack Ma

E) Zhong Shanshan

Answer: E

Solution: Zhong Shanshan, referred to as “Lone Wolf”, has replaced Ambani as Asia’s richest person; he is one of the fastest in history to achieve the feat.

Zhong Shanshan is Chinese billionaire whose net worth is 78.2 billion USD, which is attributed to the listing of Beijing Wantai Biological Pharmacy Enterprises Co and Nongu Spring Co, a bottled water firm.

48. Which among the following bank in January ’21 has announced the launch of banking services on messaging platform whatsapp?

- A) Bank of India
- B) Punjab National Bank
- C) Indian bank
- D) Bank of Baroda
- E) Canara bank

Answer: D

Bank of Baroda offers WhatsApp banking services, to activate the banking facility on WhatsApp, need to save WhatsApp number 8433 888 777 of Bank of Baroda (BoB) in phone book. The bank would be offering these services on Whats App- balance inquiry, mini statement, cheque status inquiry, cheque book request, blocking of a debit card, information on Bank’s product and services, register/apply for digital products, etc.

49. Indian student Harsh Dalal’s startup has built 120-employee business across eight cities and

won the recognition in Singapore for his start up.

What was the name of his Startup?

- A) TEAM WIN
- B) TEAM START
- C) TEAM UP
- D) TEAM WILL
- E) TEAM LABS

Answer: E

A 19-year-old Indian student in Singapore is keeping his options open on a startup named “TEAMLABS” he has built with four applications in his teenage while schooling.

While keeping up with his schooling for a diploma in business administration at Singapore Polytechnic, Harsh Dalal, as CEO, has built 120-employee Team Labs’ business across eight cities.

50. The Japanese firm Sumitomo Forestry and Kyoto University have joined the forces in the aim of developing a wooden satellite. Japan has decided to launch the first wood-based satellite by which year?

- A) 2025
- B) 2022
- C) 2028
- D) 2023
- E) 2030

Answer: D

The first ever wooden satellite could be launched from Japan in 2023.

The Japanese firm Sumitomo Forestry and Kyoto University have joined forces in the aim of developing a wooden satellite that would burn up

more readily as its lifespan ends, without leaving debris or waste behind.

51. Government has extended Income Tax Returns Filing Date To which date?

- A) January 11
- B) January 12
- C) January 10
- D) January 15
- E) January 18

Answer: C

The government extended the deadline to file income tax return (ITR) for individuals by 10 days to January 10, 2021.

Prior to that the deadline was December 31, 2020

This is the third time that the government has extended the deadline to file ITR first from the normal deadline of July 31 to November 30, 2020, and then to December 31, 2020.

The last date for filing ITR has been extended for those taxpayers whose filings using ITR-1 and ITR-4 forms are not required to be audited.

52. Veteran broadcaster Indira Joseph Venniyor who passed away was a renowned ____.

- A) Director
- B) Producer
- C) Actor
- D) Broadcaster
- E) Singer

Answer: D

Indira Joseph Venniyor, Renowned broadcaster, All India Radio Veterean, and the first English

news announcer of Travancore Radio, passed away. She was 94.

She was the wife of well-known literary scholar and art critic the late E.M.J. Venniyoor.

She is a lover of music and performing arts, she encouraged budding professionals in the fields.

53. Government has extended deadline for FASTag till which date?

- A) February 11
- B) February 13
- C) February 17
- D) February 18
- E) February 15

Answer: E

The Ministry of Road Transport and Highways has extended the deadline for FASTags for all vehicles in India till February 15, 2021.

Earlier, the National Highways Authority of India (NHAI) had announced to completely do away with cash transactions for paying toll charges from January 1.

The new deadline for FASTags to be made mandatory to cross a toll plaza has been set on February 15, 2021.

The compulsory use of FASTags will help vehicles pass through the toll plazas swiftly, preventing long queues.

54. Which state assembly has passed a Bill to abolish all government-run Madrasahs?

- A) Bihar
- B) Assam
- C) Haryana

D) Kerala

E) Madhya Pradesh

Answer: B

The Assam Legislative Assembly passed the repeal provincialisation of Madrasah Bill, 2020 to abolish all government-run Madrasahs in the state and convert them to general schools.

The new act will come into effect from April 1, 2021. The Bill was tabled in the assembly by the state government on December 28, 2020.

Assam, the state government has decided to make 'education secular' and 198 high madrasahs and 542 other madrasahs in the state will operate as any other general educational institute and will not give admission to students for theological studies.

55. Which state is organizing Exhibition Raag - Bhopali being organized to promote Zari-Zardozi?

- A) Nagaland
- B) Assam
- C) Madhya Pradesh
- D) Bihar
- E) Chhattisgarh

Answer: C

Madhya Pradesh Government is Organizing an exhibition called Raag-Bhopali is being organized to promote Zari-Zardozi crafts of Bhopal.

The exhibition is being organised till 30 December in GauharMahal, Bhopal. Chief Minister Shivraj Singh Chouhan while

inaugurating the exhibition on that fading art of Zari-Zardozi will be revived.

Different kinds of zari work

Zardozi: This is a heavy and more elaborate embroidery work which uses varieties of gold threads, spangles, beads and gota.

It is used to embellish wedding outfits, heavy coats, cushions, curtains etc.

Kamdani : This is a lighter needlework which is done on lighter material like scarves, veils, and caps.

Mina Work: This is thus called owing to its resemblance with enamel work. The embroidery is done in gold.

56. Navy and which organization has conducted a maiden trial of 1st indigenous air-droppable container?

- A) BEL
- B) BHEL
- C) BDL
- D) DRDO
- E) ISRO

Answer: D

Defence Research and Development Organisation (DRDO) along with the Indian Navy conducted the successful maiden test trial of 'SAHAYAK-NG' India's first indigenously designed and developed Air Dropped Container from IL 38SD aircraft (Indian Navy) off the coast of Goa.

The trial was conducted by the Indian Navy to enhance its operational logistics capabilities and provide critical engineering stores to ships that

are deployed more than 2000 kilometers from the coast.

SAHAYAK-NG is an advanced version of SAHAYAK Mk I.

The newly developed GPS aided air dropped container is having the capability to carry a payload that weighs up to 50 kilograms and can be dropped from heavy aircraft.

SAHAYAK-NG container was developed by two DRDO laboratories i.e. NSTL, Visakhapatnam and ADRDE, Agra along with Avantel for GPS integration.

57. Which bank has introduced a one-stop integrated travel marketplace Travel Now?

- A) Axis
- B) Yes
- C) ICICI
- D) SBI
- E) DBS

Answer: E

DBS Bank India introduced a one-stop travel marketplace within the digibank app.

Named as Travel Now, the platform enables customers to browse and book flights, bus tickets and hotels across hundreds of destinations both within and outside of India.

With the help of this new platform customers will now be able opt for travel insurance, offered by Bharti AXA General Insurance, with an automated claims process for flight cancellation, and flight departure and arrival delays of more than 60 minutes.

58. Union Cabinet has approved a Multi-Modal Logistics Hub & Multi-Modal Transport Hub (MMTH) at _____.

- A) Indore
- B) Noida
- C) Chandigarh
- D) Bhopal
- E) Surat

Answer: B

The government approved a multi-modal logistics and transport hub (MMTH) at Greater Noida in Uttar Pradesh.

For a view to making India a strong player in the global value chain. The Union Cabinet also approved a proposal to set up industrial corridor nodes at Krishnapatnam and Tumakuru under CBIC.

The proposals have a total estimated cost of Rs 7,725 crore and an estimated employment generation of more than 2.8 lakh persons

The Union Cabinet has approved proposals of Department of Promotion of Industry & Internal Trade (DPIIT) for construction of various trunk infrastructure components, which includes:

Krishnapatnam Industrial Area in Andhra Pradesh (estimated cost of the project of Rs. 2,139.44 crore)

59. India's First Testbed for Autonomous Navigation Systems has been launched at which institution?

- A) IIT Roorkee
- B) IIT Bombay
- C) IIT Delhi

- D) IIT Hyderabad
- E) IIT Madras

Answer: D

Union Minister of Education Ramesh Pokhriyal Nishank virtually laid the foundation stone of 'TiHAN-IIT Hyderabad, India's first Testbed for Autonomous Navigation Systems (Terrestrial and Aerial) at IIT Hyderabad.

The Department of Science and Technology (DST), Government of India, has sanctioned Rs. 135 crores to IIT Hyderabad under the National Mission on Interdisciplinary Cyber-Physical Systems (NM-ICPS) to set up a Technology Innovation Hub on Autonomous Navigation and Data Acquisition Systems.

The Technology Innovation Hub on Autonomous Navigation Systems for Unmanned Aerial Vehicles and Remotely Operated Vehicles at IIT Hyderabad, known as 'TiHAN Foundation' has been incorporated as a Section-8 company by the institute in June 2020.

60. Which institution has developed a plaque therapy successfully used on eye cancer patients in AIIMS?

- A) BHEL
- B) BDL
- C) BARC
- D) ISRO
- E) DRDO

Answer: C

The Bhabha Atomic Research Centre in Mumbai has developed an eye cancer therapy in the form

of the first indigenous Ruthenium 106 Plaque for the treatment of ocular tumours.

The handling of plaque is very convenient for surgeons and it has been acknowledged to be at par with international standards.

About Ocular Tumours:

Ocular tumors are tumors inside the eye.

They are collections of cells that grow and multiply abnormally and form masses.

They can be benign or malignant. In adults the most common type is metastatic, from another part of the body (lung, breast, prostate, etc).

About Ruthenium-106:

Ruthenium-106 is a radioactive form of the rare heavy metal ruthenium, which is a "platinum group" metal similar to platinum.

61. Who among the following has been conferred with Eminent Engineer Award ?

- A) Naren Singh
- B) VK Paul
- C) Suresh Mehta
- D) Ramesh Chand
- E) VK Yadav

Answer: E

Shri V.K. Yadav, Chairman & CEO, Railway Board, Ministry of Railways has been conferred with the prestigious Eminent Engineer Award for the Year 2020

The award is given by the Institution of Engineering and Technology (IET) for his outstanding contribution towards modernization and reforms over Indian Railways.

Every year the Institution of Engineering and Technology, Delhi Local Network celebrates Engineers' Day on the 15th of September to commemorate the birth anniversary of Bharat Ratna Sir M Visvesvaraya.

On this occasion, besides technical activities, the Institution also presents the Eminent Engineer's Award to distinguished Engineering personalities for their outstanding services in the field of Engineering and technology.

62. Mother Teresa Memorial Awards For Social Justice 2020 Announced. This is the ____year of the award.

- A) 12th
- B) 14th
- C) 16th
- D) 15th
- E) 13rd

Answer: C

On December 27, 2020, Harmony Foundation hosted the Mother Teresa Memorial Awards for Social Justice.

The Awards in its 16th year is the only award endorsed by Sister Prema, the Superior General of the Missionaries of Charity, the organization started by Mother Teresa.

The theme for this year's awards was, Celebrating Compassion In Times OfCovid
Dr Anthony Fauci (USA) is the Director of the National Institute of Allergy and Infectious Diseases, USA. He and his task force were

among the first ones to realize the seriousness of this pandemic.

Fr Fabio Stevenazzi (Milan, Italy) decision to return to medical practice in order to help those infected with COVID 19 has thrust him to be the modern day example of St Charles Borromeo who in 1576 during the Great Plague that hit the city of Milan and cut the population by half, stayed behind to nurse the sick and renovate hospitals.

DrPradeep Kumar (Chennai) took it upon himself to give a befitting burial to his colleague with the help of two ward boys, at a cemetery in the city in the middle of the night.

CristianFracassi and Alessandro Romaioli (Italy) CEO and Founder of ISINNOVA along with his teammate and engineer Alessandro Romaioli built prototypes on Isinnova's 3D printers, to create the parts of the use-and-throw valves for ventilators which were desperately needed in Italy and provided it to them for free helped many patients survive the terrors of this pandemic.

Sanjay Pandey, IPS (DG Home Guards, Maharashtra) went beyond the call of duty as a police officer to open the first relief camp in the Mumbai city suburbs for migrant workers whose livelihood were disrupted by the lockdown to contain the pandemic.

VikasKhanna (Manhattan, USA) heart still moves to serve the lonely and underprivileged here in India.

63. ISRO chairman K Sivan has received a _____ year extension as Department of Space secretary.

- A) 3
- B) 2.5
- C) 1.5
- D) 1
- E) 2

Answer: D

The Appointments Committee of the Cabinet has approved the extension of tenure of K Sivan, secretary, Department of Space and chairman, Space Commission, for a period of one-year beyond January 14, 2021, that is up to January 14, 2022.

Sivan is also Chairman of Indian Space Research Organisation (ISRO).

Sivan joined Isro in 1982 and was inducted into the PSLV Project.

He took over as Isro chairman in January 2018.

Under his chairmanship, the space agency launched various important projects, including Chandrayaan 2, the second mission to the moon, on July 22 last year and currently working on the human spaceflight mission.

He was the chief architect of 6D trajectory simulation software, SITARA, which is the backbone of the real-time and non-real-time trajectory simulations of all Isro launch vehicles.

64. Which city will host the much-awaited Tansen Music Festival?

- A) Mumbai
- B) Gwalior

- C) Indore
- D) Chandigarh
- E) Jaipur

Answer: B

In Madhya Pradesh, the much-awaited Tansen Music Festival began in Gwalior with strict COVID-19 guidelines in place. In the inaugural ceremony renowned santoor player PtSatishVyas was conferred upon the prestigious TansenSamman.

Bhopal-based institution Abhinav Kala Parishad was honoured with Raja MansinghTomar award. The inaugural day events started with cross-cultural offerings of Harikatha, Milad and shehnaivadan at Tansen'ssamadhisthal in Hazira.

The festival will conclude on December 30 at Behat village, the birthplace of the music maestro Tansen.

65. Dr. Harsh Vardhan has digitally inaugurated the _____ NHM National Summit on Good, Replicable Practices through a video conference.

- A) 3rd
- B) 4th
- C) 7th
- D) 5th
- E) 6th

Answer: C

Dr. Harsh Vardhan, Union Minister of Health and Family Welfare digitally inaugurated the 7th National Summit on Good, Replicable Practices through a video conference.

Dr. Vardhan also launched New Health Management Information System (HMIS) along with the Operational Guidelines for TB services at AB-HWCs and the Operational Guidelines 2020 on Active Case Detection and Regular Surveillance for Leprosy.

Main Objective : to recognize, showcase and document various best practices and innovations in public healthcare system

66. Global family Day 2020 is observed on which of the following date?

- A) January 3
- B) January 15
- C) January 4
- D) January 5
- E) January 1

Answer: E

Global Family Day is an annual celebration observed on January 1st of every year.

People all over the world find no time to spend with their family.

The reason varies from person to person due to their work, living atmosphere, and so on.

This Day is celebrated as the global day of peace and sharing in the United States.

Spending time with the family members has reasonably reduced in recent years.

The Day aims in promoting peace and sharing. Assembly's declaration made in 1997 started with the theme "One Day of Peace" which was then observed on the first day of every year to welcome the New Year.

67. Who among the following has recently launched the Global PravasiRishta portal & mobile App to connect with Indian Diaspora across the world?

- A) Anurag Thakur
- B) Prahlad Patel
- C) V.Muraleedharan
- D) S.Jaishankar
- E) NarendraModi

Answer: C

Minister of State for External Affairs V. Muraleedharan launched the Global PravasiRishta portal and mobile App, to connect with Indian Diaspora across the world.

About the Portal :

The portal will act as a dynamic communication platform between our pravasis, the Ministry of External Affairs and missions abroad and will help in engaging Indian diaspora more intensively.

The portal will also assist the Indian overseas during any crisis management and will also lend a helping hand.

The portal will also contain useful information for the Indian diaspora such as information on passport, visa, and other consular services. It will also have the details about various events that are organized by the missions and the invites will be sent to diaspora members for greater participation.

The dynamic nature of the portal and the app will also allow the ministry to take useful opinions of the Indian diaspora on policy issues, conducting surveys, sharing e-newsletters, etc.

PravasiBharatiya Divas (PBD) is celebrated on 9th January every year to mark the contribution of the Overseas Indian Community in the development of India.

68. PM Modi has laid the foundation stone of Light House projects (LHPs) across ___ states via video conference.

- A) 4
- B) 8
- C) 7
- D) 6
- E) 5

Answer: D

On 1st January Prime Minister NarendraModi laid the foundation stone of Light House projects (LHPs) under Global Housing Technology Challenge (GHTC)- at six sites across six States, through video conference.

The projects are being undertaken under the Global Housing Technology Challenge (GHTC). The LightHouse Projects will be undertaken at Rajkot in Gujarat, Lucknow in Uttar Pradesh, Indore in Madhya Pradesh, Ranchi in Jharkhand, Chennai in Tamil Nadu and Agartala in Tripura. The project will comprise around 1000 houses at each location along with allied infrastructure facilities.

It will mainly aim to deliver ready to live houses at a fastened pace within twelve months.

The Chief Ministers of all six states took part in the foundation laying ceremony.

It has been conceptualised by the Union Ministry of Housing and Urban Affairs.

The LightHouse Projects will showcase the best use of new-age alternate global technologies, processes and materials in the construction sector at such a large scale for the first time in the country.

These houses will be more economical, sustainable, durable and of high quality in comparison to the conventional brick and mortar construction.

69. Indian Army Chief MM Naravane receives Guard of Honour at Army Headquarters of which country?

- A) Israel
- B) France
- C) South Korea
- D) Nepal
- E) Bhutan

Answer: C

Chief of Army Staff General MM Naravane has received a Guard of Honour at Republic of Korea Army Headquarters at Gyeryong, South Korea. He called on General Nam Yeong shin, Chief of Staff of Korean Army and discussed issues of bilateral defence cooperation.

The Army chief visited the Demilitarized Zone (DMZ) near the border with North Korea. General Naravane visited the 30th Armoured Brigade and DMZ.

During his three day visit, he met senior military and civilian leadership of the Republic of Korea and discussed avenues for enhancing defence relations between the two countries.

70. Prime Minister has laid the Foundation stone of AIIMS in which state recently?

- A) Chhattisgarh
- B) Haryana
- C) Bihar
- D) Gujarat
- E) Madhya Pradesh

Answer: D

Prime Minister Narendra Modi laid the foundation stone of All India Institute of Medical Sciences (AIIMS) at Rajkot in Gujarat through video conferencing.

Gujarat Governor Acharya Devvrat, Union Health Minister Dr. Harsh Vardhan and Union Minister of State for Health Ashwini Kumar Choubey were also present on the occasion.

AIIMS will play a big role in ensuring the modern health care facility reaches to the last mile in the State.

Under AIIMS project, 201 acres of land has been allotted near Rajkot.

It will be built at an estimated cost of Rs 1,195 crore and is expected to be completed by mid of 2022.

The state-of-the-art 750-bed hospital will also have a 30-bed AAYUSH block.

It will have 125 MBBS seats and 60 nursing seats.

71. DRDO has recently celebrated its ____ Foundation Day of its establishment on January 01, 2021.

- A) 58th
- B) 60th

- C) 61st
- D) 62nd
- E) 63rd

Answer: E

The DRDO observed the 63rd Foundation Day of its establishment on January 01, 2021.

DRDO was established in 1958 with just 10 laboratories to enhance the research work in the Defence sector.

It was tasked with designing and developing cutting edge defence technologies for Indian Armed Forces.

DRDO is working in multiple cutting edge military technology areas, which include aeronautics, armaments, combat vehicles, electronics, instrumentation, engineering systems, missiles, materials, naval systems, advanced computing, simulation, cyber, life sciences and other technologies for defence.

72. PM Modi has inaugurated a permanent campus of IIM Sambalpur in which state?

- A) Chhattisgarh
- B) Haryana
- C) Odisha
- D) Bihar
- E) Madhya Pradesh

Answer: C

Prime Minister NarendraModi will lay the foundation stone of the permanent campus of the Indian Institute of Management (IIM), Sambalpur, on January 2 via video-conferencing.

Odisha Governor GaneshiLal and Odisha Chief Minister Naveen Patnaik along with Union

Ministers Ramesh Pokhriyal 'Nishank', DharmendraPradhan and Pratap Chandra Sarangi will also be present on the occasion.

The ceremony will be virtually attended by more than 5,000 invitees, including officials, industry leaders, academicians and students, alumni and faculty of IIM, Sambalpur.

The institute also outscored all other IIMs in terms of highest gender diversity with 49 per cent girl students in the MBA batch of 2019-21 and 43 per cent in the 2020-22 MBA batch.

The proposed campus of IIM Sambalpur will be equipped with State-of-the-art infrastructure with energy efficient green features as per GRIHA standards.

It will be a green campus with maximum usage of renewable energy.

The project is scheduled to be completed by April 2022.

73. Petroleum Minister has launched missed call facility for LPG consumers in which city?

- A) Chandigarh
- B) Delhi
- C) Kolkata
- D) Bhubaneswar
- E) Indore

Answer: D

Union Minister for Petroleum and Natural Gas and Steel DharmendraPradhan launched the missed call facility for LPG consumers in Bhubaneswar.

Indian Oil LPG customers can now give a missed call to 8454955555 for refill booking for all India and for new connection for Bhubaneswar city.

The Minister also rolled out the second phase of the world class octane 100 premium grade petrol, under the brand XP 100.

The Petroleum Minister said that while about 13 crore people were given LPG connection between 1955 and 2014, now it is about to reach 30 crore, representing a quantum jump there by empowering Indian women.

Rolling out the Indian Oil's branded XP 100 to seven more cities including Bhubaneswar, Mr Pradhan said it epitomizes the Prime Minister's vision of Purvoday.

"In the line Modi's vision for a Digital India, the missed call facility will play a crucial role in making LPG more easily accessible to the consumers.

The Petroleum Ministry has always strived to improve customer convenience and this facility by IndianOil will play a crucial role in making LPG more easily accessible.

74. Who among the following has inaugurated the Virtual Agri-hackathon 2020?

- A) Prahlad Patel
- B) Nitin Gadkari
- C) Venkiah Naidu
- D) Narendra Modi
- E) NS Tomar

Answer: E

Virtual Agri-hackathon Atmanirbhar Krishi inaugurated To make Agriculture profitable and

attract youth towards agriculture are challenges of the Agri-hackathon

Union Minister of Agriculture & Farmers' Welfare Shri Narendra Singh Tomar said Agri-Startups can help improve the lot of farmers

Building Smart India with Self-Reliant Agriculture. The application of the hackathon was made live on mygov.in and will remain open till 20 January, 2021.

The hackathon will happen in 3 elimination rounds and the final 24 winners will get a cash prize of INR 1,00,000 along with incubation support, tech & business mentoring and various other benefits.

The hackathon will accept innovations & ideas on farm mechanization, precision agriculture, supply chain & food technology, waste to wealth, green energy, etc.

Narendra Singh Tomar said "In the light of Prime Minister's vision to introduce new-age technology and innovations in agriculture, the Agri India Hackathon is being organised.

It is a proud moment for all of us where young minds will discuss, collaborate, and create some of the best ideas & solutions which will guide us for years to come.

Agriculture is the backbone of our country and plans are afoot to strengthen this backbone with youth engagement, employment generation, technology & digitization".

75. India is all set to begin its _____ year tenure as a non-permanent member in UNSC.

- A) 6

- B) 1
- C) 2
- D) 3
- E) 4

Answer: C

India will begin its two-year tenure as a non-permanent member of the United Nations Security Council (UNSC).

India will sit in the 15-nation UNSC for the 2021-22 term as a non-permanent member — the eighth time that the country has had a seat on the powerful horseshoe table.

On January 1, India, Norway, Kenya, Ireland and Mexico will join non-permanent members Estonia, Niger, Saint Vincent and the Grenadines, Tunisia and Vietnam and the five permanent members China, France, Russia, U.K. and the U.S.

India will be UNSC President in August 2021 and will preside over the council again for a month in 2022.

76. Which country has recently changed the words of its national anthem?

- A) France
- B) Australia
- C) England
- D) Malaysia
- E) Singapore

Answer: B

On new year eve, Australia has changed one word in its national anthem to reflect “the spirit of unity” and the country’s Indigenous population.

Prime Minister of Australia Scott Morrison announced that the second line of the anthem, Advance Australia Fair, has been changed from For we are young and free to For we are one and free.

Minister for Indigenous Australians Ken Wyatt, who is also the first Indigenous Australian elected to the federal Parliament’s lower house, has given his support to the change.

He said that the one-word change was small in nature but significant in purpose.

77. Who among the following has launched the IAF e-Governance (e-Office) portal?

- A) Rajnath Singh
- B) Anurag Thakur
- C) Prahlad Patel
- D) RKS Bhadauria
- E) Narendra Modi

Answer: D

Indian Air Force Chief, Air Marshal R K S Bhadauria launched the IAF e-Governance (e-Office) portal in New Delhi.

Bhadauria launched the portal at VayuBhawan. The launch of the portal is part of Digital India and e-governance initiative that will transform the entire Indian Air Force into a paperless office workflow.

It marks a major shift from the current method of correspondence, filing and documentation to a digital one.

The platform will ensure enhanced transparency, improved efficiency, increased accountability, assured data integrity and rapidly accessible

archives along with a major reduction in the use of paper.

This project started in April and was to be completed by January 1, 2021

78. India and ADB have signed USD _____ million loan to augment electricity generation capacity in Assam.

- A) 260
- B) 245
- C) 231
- D) 250
- E) 247

Answer: C

India and Asian Development Bank (ADB) have signed a USD 231 million loan to augment electricity generation capacity in the State of Assam through construction of a 120 MegaWatts hydroelectric power plant that will enhance availability of electricity for households.

This is the third tranche loan for the ongoing Assam Power Sector Investment Programme that was approved by the ADB Board in July 2014.

The programme, including its two previous tranches, focuses on enhancing capacity and efficiency of the energy generation and distribution systems in Assam to improve electricity service to end users.

79. Which state has launched a Crop Relief Scheme - KisanFasalRahatYojana?

- A) Karnataka
- B) Chhattisgarh

- C) Kerala
- D) Jharkhand
- E) Assam

Answer: D

Jharkhand is set to replace the Prime Minister's insurance scheme for farmers with its own crop relief scheme - KisanFasalRahatYojana.

To be launched on December 29, the scheme will take three months to come into effect.

What is Jharkhand's KisanFasalRahatYojana?

It is a compensation scheme aimed at providing security cover to Jharkhand farmers in case of crop damage due to natural calamity.

It will cover both land owning and landless farmers. The Department of Agriculture, Animal Husbandry and Co-operative will be the implementing agency and it will work in association with a project management unit, which will be a consultancy firm that will take care of technical requirements.

Food safety, crop diversification, rapid development in agriculture and paving the way for competition, are among the aims of the scheme. It is not an insurance scheme where premiums are paid.

80. Chief of Naval Staff recently visited INS Dwarka in which state?

- A) Madhya Pradesh
- B) Karnataka
- C) Gujarat
- D) Kerala
- E) Maharashtra

Answer: C

Admiral Karambir Singh, the Chief of the Naval Staff (CNS) visited INS Dwarka, Indian Navy's forward operating base at Okha, Gujarat, on new year's eve.

The CNS was briefed by the Flag Officer Commanding Gujarat, Daman and Diu on maritime operations and security aspects relevant to Gujarat, Daman & Diu (GD&D) Naval Area.

He also took stock of coastal surveillance initiatives by GD&D Area and interacted with personnel from Naval Station Okha and other units.

Appreciating the quality work put in by the station, he encouraged the personnel to keep up the good work as INS Dwarka enters its golden jubilee year.

The CNS also wished all personnel and families at GD&D Area the very best for the new year.

81. State-owned _____ announced the extension of its festival bonanza offer till March.

- A) HDFC
- B) ICICI
- C) SBI
- D) BOB
- E) PNB

Answer: E

State-owned Punjab National Bank NSE 0.92 % (PNB) announced the extension of its festival bonanza offer till March.

The promotional scheme has now been rechristened as "PNB NEW YEAR BONANZA-2021", the bank said in a statement.

"Under the PNB New Year Bonanza 2021 (during the offer period from January 1 to March 31, 2021), PNB will offer a full waiver of upfront or processing fees and documentation charges on all fresh housing loans, takeover housing loans, car loans, and property loans," it said. About PNB:

82. Post Office Savings Bank be apt interconnected with other banks by which month?

- A) August
- B) April
- C) March
- D) June
- E) July

Answer: B

India Post expects to make the Post Office Savings Bank interoperable with other bank accounts by April and will focus on enhancing digitisation of all services in 2021, a senior official of the department said.

Department of Posts Secretary Pradipta Kumar Bisoi said that The postal department during the lockdown was at the frontline to deliver essential parcels when rail, road and air traffic were grounded and continues to enhance capacity as trains are not fully operational yet.

83. RuPay partners with which Bank to introduce 'RuPayPoS'?

- A) Axis
- B) ICICI
- C) SBI

D) RBL

E) HDFC

Answer: D

National Payments Corporation of India (NPCI) announced that RuPay has partnered with RBL Bank to launch an innovative payment solution for Indian merchants – RuPayPoS in association with PayNearby.

The RuPayPoS will transform smartphones into merchant Point of Sale (PoS) terminals for the retailers.

Merchants will now be able to accept contactless payments of up to INR 5000 through a simple tap and pay mechanism on his NFC enabled mobile phones.

Customers using RuPay cards or have tokenized their RuPay Cards, can carry out contactless payments for their regular purchases.

The introduction of RuPayPoS to digitally empower merchants by turning their smartphones into a PoS machine

RuPayPoS will provide cost effective acceptance infrastructure to retailers at no additional capital cost.

This unique phenomena will proliferate digital payments acceptance among millions of underserved Indian MSMEs.

84. IFSCA has become an associate member of the global lobby group ____.

A) UNICEF

B) UNESCO

C) WB

D) IMF

E) IOSCO

Answer: E

International Financial Services Centres Authority (IFSCA) has become an associate member of the International Organization of Securities Commissions (IOSCO).

The IOSCO works closely with the G20 nations and the Financial Stability Board (FSB), in setting up the standards for strengthening the securities markets.

The IOSCO Objectives and Principles of Securities Regulation have been endorsed by FSB as one of the key standards for sound financial systems.

The membership of IOSCO will provide the IFSCA a platform to exchange information at the global level, and even at the regional level, on areas of common interests.

With this new membership, IFSCA will get the platform to exchange information at the global level and regional level on areas of common interests and help to learn from the experiences and best practices of the regulators of other well established financial centres.

85. P Ravi Kumar appointed as Chief Secretary of which state?

A) Chhattisgarh

B) Telangana

C) Karnataka

D) Gujarat

E) Kerala

Answer: C

Senior IAS officer P Ravi Kumar has been appointed as Karnataka's 38th chief secretary. He will replace TM Vijay Bhaskar who will superannuate on December 31 2020.

About P. Ravi Kumar:

He is 1984-batch IAS officer Ravi Kumar is currently additional chief secretary (ACS) and was earlier Karnataka Chief Minister BS Yediyurappa's ACS.

Ravi Kumar is the second senior most IAS officer of Karnataka cadre after Bhaskar.

86. Who among the following has taken over the charge of new Chairman & CEO of Railway Board?

- A) AnandVarma
- B) Sumeet Sharma
- C) Manoj Kumar
- D) Surender Singh
- E) Vishesh Singh

Answer: B

Suneet Sharma has been appointed as the new Chairman & Chief Executive Officer (CEO), Railway Board (Ministry of Railways) and ex-officio Principal Secretary to Government of India.

Prior to this, Suneet Sharma worked as General Manager, Eastern Railway.

He took over in his new role with effect from January 01, 2021.

Suneet Sharma joined the Indian Railways in 1979 as a Special Class Apprentice while he was studying engineering at IIT Kanpur.

He was Chief Workshop Manager, Parel workshop in Mumbai where he was instrumental in manufacturing narrow gauge locomotives for hill railways.

He also restored an old steam narrow gauge locomotive for the heritage Matheran line near Mumbai.

87. Soma Mondal has taken over from Anil Kumar Chaudhary as Chairman of which organization?

- A) HPCL
- B) ONGC
- C) BDL
- D) SAIL
- E) BHEL

Answer: D

Soma Mondal has taken over as Chairman of Steel Authority of India Limited (SAIL) with effect from January 01, 2021.

Before joining SAIL as a Director, Mondal was the Director (Commercial) at fellow Central public sector enterprise, National Aluminium Company Limited (NALCO).

She replaces Anil Kumar Chaudhary, who superannuated on 31 December 2020.

Under her leadership, the company launched niche branded products like NEX (Structural) and SAIL SeQR (TMT bars), a company.

88. Narendra 'Bull' Kumar who passed away was a famous _____.

- A) Actor
- B) Director

- C) Writer
- D) Singer
- E) Mountaineer

Answer: E

Ace mountaineer Colonel Narendra 'Bull' Kumar, 87, who helped India secure the Siachen Glacier, passed away.

He earned the nickname 'Bull' for relentlessly charging into everything he did.

India had launched 'Operation Meghdoot' in April 1984 to gain total control of the strategically-located glacier as well as nearby passes following Col Kumar's ground report about Pakistani activities.

89. Who among the following has been appointed Deputy Election Commissioner?

- A) Naveen Gupta
- B) Sumit Singh
- C) UmeshSinha
- D) Manoj Kumar
- E) Anand Raj

Answer: C

UmeshSinha has been appointed as the deputy election commissioner in the Election Commission of India, according to a Personnel Ministry order.

Sinha, a 1986-batch IAS officer (retired) of the Uttar Pradesh cadre, is at present the secretary general in the commission.

The Appointments Committee of the Cabinet has approved extension in the term of reemployment of Sinha as deputy election commissioner on contract basis for a period of six months beyond

December 31, 2020, that is up to June 30, 2021, it said.

Sinha is a part of a committee set up by the Election Commission to look into the issue of revising the election expenditure of candidates during campaigning.

90. Which state government has promoted 3 IPS Officers recently?

- A) Haryana
- B) Punjab
- C) Kerala
- D) Chhattisgarh
- E) Madhya Pradesh

Answer: B

The Punjab Government has promoted three Additional Director Generals of Police (ADGPs) to the rank of DGP.

ADGPs SanjeevKalra, B K Uppal, and Parag Jain, who are IPS officers, have been promoted to the rank of Director General of Police (DGP) from January 1.

Parag Jain, IPS, who is presently on central deputation with cabinet secretariat, New Delhi would be entitled only to the notional benefits and the actual benefits would be admissible as and when he would join his duty in the state government.

It is mentioned here that SanjeevKalra is ADGP railways at Patiala and BK Uppal is holding charge of state vigilance bureau chief.

91. DRDO's 'Scientist of the Year' award has been won by whom?

- A) SushilGupte
- B) AnandTiwary
- C) Hemant Kumar Pandey
- D) Manoj Kumar
- E) SurenderPrakash

Answer: C

'LUKOSIN' Developer and Senior scientist Hemant Kumar Pandey has been honoured with DRDO's 'Scientist of the Year Award' for his contribution in developing several herbal medicines, including the popular drug Lukoskin meant for treatment of leucoderma.

A recipient of several prestigious awards for his contribution in the field of herbal medicine, Pandey has been undertaking research at the Defence Research and Development Organisation's (DRDO) lab Defence Institute of Bio-Energy Research (DIBER) at Pithoragarh in Uttarakhand for the past 25 years.

Defence Minister Rajnath Singh had recently facilitated the scientist at an event here with the prestigious award that comprises a certificate and cash prize of Rs 2 lakh.

92. GST collections for December has been highest ever at Rs _____ lakh crore.

- A) 1.05
- B) 1.10
- C) 1.30
- D) 1.24
- E) 1.15

Answer: E

Goods and Services Tax collections for December Rs 1.15 lakh crore, the highest ever

since the implementation of the nationwide tax in July 2017.

The previous monthly GST collection record was just short of Rs 1.14 lakh crore in April 2019.

The revenues for the month of December 2020 are 12 percent higher than the GST revenues in the same month in 2019.

In November 2020, the GST collection had crossed Rs 1 lakh crore mark.

This has been due to the combined effects of the rapid economic recovery and the nationwide drive against the GST evaders and fake bills along with many systemic changes introduced recently, which have led to improved compliance.

93. J&K UT Administration has signed an MoU with which organization?

- A) ONGC
- B) BHEL
- C) HPCL
- D) NAFED
- E) NAREDCO

Answer: D

In Jammu and Kashmir, the Union Territory Administration signed a historic Memorandum of Understanding (MoU) with National Agricultural Cooperative Marketing Federation of India Ltd. (NAFED), an apex organization of marketing cooperatives for agricultural produce.

The MoU with NAFED is seen as a game changer for the Horticulture sector in Jammu and Kashmir.

High Density plantation of Apple, Walnut, Cherry, Flowers etc has potential to increase the income of farmers by 3 to 4 times.

After signing of the MoU, NAFED to cover 5500 Hectares at a cost of Rs.1700 Crore in the next five years with major focus on Apple, Walnut, Cherry, Pear and other significant horticulture produce. NAFED will also set up 20 Farmer-Producer Organizations, one in each district, in the next three months.

The NAFED will set up three cold storage clusters, one each in North Kashmir, South Kashmir and Kathua at a cost of Rs.500 Crore, besides ensuring Geographical Indications tags (GI Tags) for all premium/niche horticulture produce, branding and marketing of fruit crops like Apple, Walnut, Cherry, Olive, Litchi etc.

94. ADB and India have signed a _____million loan to support project preparation to expand horticulture in Himachal Pradesh.

- A) 14
- B) 13
- C) 10
- D) 11
- E) 12

Answer: C

The Asian Development Bank (ADB) and the Government of India on 30th December 2020 signed a \$10 million project readiness financing (PRF).

Mainly to help finance piloting activities, and design and capacity building for an ensuing project that aims to expand horticulture

production and farm household income in the hill state of Himachal Pradesh.

The PRF project aims to ensure implementation readiness with prior testing of new production technologies and marketing systems so that the ensuing project is cost-effective and gets completed in a timely manner to enhance farm profitability.

95. John Fulton Reid who died at the Age of 64 played for which country?

- A) England
- B) New Zealand
- C) West Indies
- D) Australia
- E) South Africa

Answer: B

On December 28, 2020, John Fulton Reid, New Zealand cricketer passed away. He was 64.

The left-handed batsman, who made his Test debut against Pakistan in 1979, played 19 Tests and 25 ODIs for his country, mostly batting at No 3.

He finished his Test career with a noteworthy average of 46.28, scoring six hundreds. He compiled his highest Test score of 180 against Sri Lanka in Colombo in 1984.

Reid was one of the key members of the successful New Zealand side in the 1980s, and is fondly remembered for his crucial hand of 108 and his stand of 224 with Martin Crowe versus Australia at the Gabba in 1985.

He served as the chief executive of Auckland Cricket,

And then he was appointed the cricket operations manager and high performance manager of New Zealand Cricket. Reid also played a leading role in the establishment of the National High Performance Centre at Lincoln.

96. World Braille Day Observed is observed on which date?

- A) January 1
- B) January 14
- C) January 4
- D) January 15
- E) January 12

Answer: C

World Braille Day is observed every year on 4 January to celebrate the importance of braille, a form of communication and written language for people who are blind and visually challenged. The day commemorates the birth anniversary of Louis Braille, the man who invented braille in the year 1809.

Aim of the day : The day aims to raise awareness about braille language and other forms of communication, As many establishments such as banks, restaurants, hospitals still don't offer braille versions of their printed materials, the day serves as a reminder of the importance of accessibility and independence for people who are visually impaired.

97. ShantanuMohapatra who died at 84 in Bhubaneswar was an eminent ____.

- A) Actor
- B) Writer
- C) Director
- D) Musician
- E) Dancer

Answer: D

Legendary Odia music director ShantanuMohapatra died in Bhubaneswar on December 30 .He was 84 years old. Born at Baripada in Mayurbhanj district in 1936. ShantanuMohapatra was the first Odia music director to work with acclaimed singers and music composers of the Hindi film industry. These included LataMangeskar (Surjyamukhi), Mohd Rafi (Arundhati), Manna Dey (Surjyamukhi), UshaMangeskar (Arundhati) and other artists like Suresh Wadekar, AnuradhaPaudwal, UshaUthup, Kavita Krishnamurthy, etc. He composed the first modern lullaby in AIR, first qawali, first bhangra tune, and first fusion and jumping note.

98. Indian SARS-CoV-2 Genomics Consortium (INSACOG) has been launched under the leadership of ____.

- A) MoH&FW
- B) AIIMS
- C) CSIR
- D) ICMR
- E) NCDC

Answer: E

The Central government has formed a genomic surveillance consortium for laboratory and

epidemiological surveillance of circulating strains of the SARS-CoV-2 in India.

The Indian SARS-CoV-2 Genomic Consortia (INSACOG) has been launched. Coordinated by the Department of Biotechnology (DBT) along with MoH&FW, ICMR, and CSIR, the strategy and roadmap of the National SARS CoV2 Genome Sequencing Consortium (INSACOG) has been prepared.

The genomic surveillance consortium, INSACOG, has been formed under the leadership of the National Centre for Disease Control (NCDC), New Delhi.

Aim : To monitor the genomic variations in the SARS-CoV-2 on a regular basis through a multi-laboratory network. This vital research consortium will also assist in developing potential vaccines in the future.

99. Drug regulator has given final approval for Covid-19 vaccines of which of the following?

- A) Sputnik V
- B) SII
- C) Cipla
- D) Pfizer
- E) Ranbaxy

Answer: B

The Drugs Controller General of India (DCGI) has formally announced the final approval for Oxford-AstraZeneca and Bharat Biotech vaccines against the coronavirus disease (Covid-19) for emergency use.

CDSCO (Central Drugs Standard Control Organisation) accepts the subject expert

committee reform rations on Serum and Bharat Biotech Covid vaccines.

About Covishield :

The subject expert committee (SEC) under CDSCO had recommended Oxford-AstraZeneca's vaccine, which is being manufactured by the Serum Institute of India (SII) as Covishield, for emergency use and Covaxin for restricted use.

100. Which organization has released data on Police Organizations?

- A) RPF
- B) CRPF
- C) CISF
- D) BPRD
- E) NitiAayog

Answer: D

The Bureau of Police Research & Development (BPR&D) released Data on Police Organizations. The BPR&D has been publishing the Data on Police Organizations (DoPO), annually, since the year 1986.

Do PO as on 01.01.2019 was released by the Union Home Minister ShriAmit Shah, on 29th January, 2020.

This is for the first time in the history of BPR&D that DoPO for a particular year has been released during the year itself.

The number of people getting police protection across India stood at 19,467 in 2019 and 21,300 in 2018 a reduction of 1,833 (or 8.7 percent).

The number of police personnel put on protection duty in 2018 and 2019 for ministers, MPs, MLAs,

judges, bureaucrats, etc., outnumbered their sanctioned strength for the job by around 35 percent.

101. Who among the following has released the inaugural issue of 'National Police K-9 Journal'?

- A) Anurag Thakur
- B) Prahlad Patel
- C) Amit Shah
- D) Narendra Modi
- E) Venkiah Naidu

Answer: C

Home Minister Amit Shah released the inaugural issue of the National Police K-9 Journal in New Delhi.

It is the first such publication in the country on the subject of Police Service K9s, Police Dogs.

This is a unique initiative that will further enrich the subjects related to Police Service Dog, K-9, PSK teams in the country.

The event was attended by Home Secretary Ajay Bhalla, Directors General of Central Armed Police Forces and senior ranking Police Officers of the Forces, while CAPF personnel from all over the country attended through virtual conference.

102. RBI has recently introduced the Digital Payments Index with the base year as _____.

- A) 2019
- B) 2018
- C) 2017
- D) 2016
- E) 2015

Answer: B

The Reserve Bank of India has constructed a composite Digital Payments Index (DPI) to capture the extent of digitisation of payments across the country.

The RBI-DPI comprises 5 broad parameters that enable measurement of deepening and penetration of digital payments in the country over different time periods.

These parameters are

Payment Enablers (weight 25%),

Payment Infrastructure – Demand-side factors (10%),

Payment Infrastructure – Supply-side factors (15%),

Payment Performance (45%) and

Consumer Centricity (5%).

The RBI-DPI has been constructed with March 2018 as the base period, i.e. DPI score for March 2018 is set at 100. The DPI for March 2019 and March 2020 work out to 153.47 and 207.84 respectively, indicating appreciable growth.

RBI-DPI shall be published on RBI's website on a semi-annual basis from March 2021 onwards with a lag of 4 months.

The base period for RBI-DPI is March 2018.

This means that the DPI score for March 2018 is set at 100.

103. Government has extended the benefit of the RoDTEP scheme to all export goods to boost exports based on the recommendation of _____ committee.

- A) Ramesh Chand

- B) VK Paul
- C) V Srinivasan
- D) GK Pillai
- E) Suresh Mathur

Answer: D

Government has decided to extend the benefit of the scheme for Remission of Duties and Taxes on Exported Products (RoDTEP) to all export goods to boost exports.

The scheme will refund to exporters the embedded Central, State and local taxes that were so far not being given rebate or refunded.

The refund will be credited in the exporter's ledger account with Customs and used to pay Basic Customs duty on imported goods.

The RoDTEP rates will be notified shortly by the Department of Commerce, based on the recommendation of a Committee chaired by former Commerce and Home Secretary Dr. G.K. Pillai

104. The government of which state has Permitted all shops to remain open for 24x7?

- A) Telangana
- B) Andhra Pradesh
- C) West Bengal
- D) Kerala
- E) Karnataka

Answer: E

All shops and commercial establishments employing ten or more people in Karnataka are now allowed to operate on a 24x7 basis, the state government.

The move is aimed at generating employment and accelerating economic growth.

The permission is subject to the establishments which employ ten or more people.

The state government also mandated that no employee will be made to work more than eight hours and in case of overtime the working hours should exceed ten hours a day and 48 hours in a week.

105. ISRO to launch the first satellite developed entirely by which country's space agency?

- A) US
- B) Japan
- C) Brazil
- D) France
- E) Germany

Answer: C

The Indian Space Research Organisation (Isro) is set to launch Amazonia-1, the first satellite to have been developed completely in Brazil by the National Institute for Space Research (INPE), the Latin American nation's apex space research body.

Emirates SkyCargo, the freight division of Emirates airline, has executed a cargo charter to transport Amazonia-1 from Sao Jose dos Campos, Brazil to Chennai. This is the first time that Emirates SkyCargo has transported a space satellite from South America.

The satellite is due to be sent to space in February 2021 from the SatishDhawan Space Centre on the East coast of India.

India and Brazil signed a Framework Agreement for cooperation in the field of outer space in January 2004. Apart from this, an agreement on the programme of cooperation between the two space agencies was also signed. Under this, Brazil received data from ISRO's remote sensing satellite ResourceSAT-1.

106. Which company has signed a contract with Indian Navy for Initial Supply of indigenously developed Laser Dazzlers?

- A) ISRO
- B) BEL
- C) DRDO
- D) BDL
- E) GRSE

Answer: B

Bharat Electronics Limited (BEL) has signed a contract with Indian Navy for initially supplying 20 Light Amplification by Stimulated Emission of Radiation Dazzlers (Laser Dazzlers) in New Delhi. The BEL had earlier this month won the contract beating global Original Equipment Manufacturers (OEMs) in the global category.

These would be manufactured by BEL, Pune plant.

Laser dazzler technology was developed by Defence Research and Development Organisation (DRDO).

This unique product is indigenously designed and developed for the first time for the Armed Forces.

107. Which country will be a co-chair of a regional forum to conserve wildlife habitats - Asia Protected Areas Partnership (APAP)?

- A) Thailand
- B) China
- C) Russia
- D) India
- E) Qatar

Answer: D

India has been chosen as the IUCN-supported Asia Protected Areas Partnership (APAP) for 3 years and it could, on this capability, help different Asian nations in managing their protected areas.

About APAP :

The APAP is a regional platform to assist governments and different stakeholders to collaborate for more practical administration of protected areas (PA) within the region.

The APAP presently consists of 21 members from 17 nations together with China, Japan, South Korea, Nepal, Bhutan, Sri Lanka and Bangladesh.

The APAP, formally launched at the IUCN World Parks Congress in Australia in 2014, is chaired by IUCN Asia and co-chaired by an APAP nation member.

India will substitute South Korea which held this place for 3 years until November, 2020.

Currently there are 21 members from 17 international locations.

108. Who among the following has inaugurated the National Metrology Conclave 2021?

- A) Amit Shah
- B) Prahlad Patel
- C) NarendraModi
- D) Harsh Vardhan
- E) Anurag Thakur

Answer: C

Prime Minister inaugurates National Metrology Conclave 2021 through video conferencing.

National Metrology Conclave 2021 was organised by the Council of Scientific and Industrial Research-National Physical Laboratory, New Delhi.

Science and Technology Minister Dr. Harsh Vardhan and Director General, CSIR, ShekharMande and Principal Scientific Adviser to the Central Government, Professor K VijayRaghavanwere also present on the occasion.

Theme of 2021 : Meteorology for the Inclusive Growth of the Nation.

He also The National Atomic Time Scale generates Indian Standard Time with an accuracy of 2.8 nanosecond.

BhartiyaNirdeshakDravya aims at supporting testing and calibration of laboratories for quality assurance, at par with international standards.

109. Leon Mendonca has become India's _____ chess Grandmaster.

- A) 63rd
- B) 64th
- C) 65th
- D) 66th
- E) 67th

Answer: E

Goa's 14-year-old Leon Mendonca has become India's 67th chess GrandMaster (GM) by winning the third and final norm at a tournament in Italy. Mendonca, who achieved the feat at 14 years, 9 months and 17 days, is the second GM from the Coastal State.

The All India Chess Federation (AICF) acknowledged the development. Leon is the second Indian to become GM this year after G. Akash.

He achieved his first GM norm at the Rigo Chess GM Round Robin in October while the second came at the first Saturday in Budapest in November. His final GM norm came at the Vergani Cup in Italy that ended on December 30. GM is a title awarded by FIDE (International Chess Federation). It is the highest title a chess player can obtain apart from World Champion.

110. Buta Singh who passed away recently belonged to which political party?

- A) CPI
- B) JDU
- C) Congress
- D) BJP
- E) BJD

Answer: C

Former Union minister, ex-MP from Rajasthan and Congress leader Buta Singh passed away. He was 86.

About ButaSingh :

Born in 1934 in Punjab's Jalandhar, Buta Singh joined the Congress under Jawaharlal Nehru's

leadership and was close to Indira Gandhi and Rajiv Gandhi, both.

Mr Singh was first elected to the Parliament in 1962.

He also served as the Home Minister in the Rajiv Gandhi government from 1986 to 1989, National President of Scheduled Caste Commission, governor for West Bengal and Bihar, and Union minister for Agriculture, Railways, Commerce and Sports, among other departments.

He subsequently held many positions including those of the Union home minister and Union agriculture minister.

He was the chairperson of the National Commission For Scheduled Caste from 2007 to 2010.

He also authored a collection of articles on Punjabi literature and Sikh history and wrote a book Punjabi Speaking State: A Critical Analysis.

111. National Bird Day is observed on which of the following date?

- A) January 1
- B) January 3
- C) January 5
- D) January 9
- E) January 7

Answer: C

In 2002, Born Free USA in coordination with the Avian Welfare Coalition launched the first annual National Bird Day to promote avian awareness.

Nature lovers, bird lovers, and bird watchers across the country annually recognize National Bird Day on January 5th.

According to Born Free USA, nearly 12 percent of the world's almost 10,000 bird species are in danger of extinction.

112. Which division of the Indian Railways will start a train service connecting international airport?

- A) Western
- B) South Central
- C) Northern
- D) South Western
- E) Eastern

Answer: D

Indian Railways' South Western Railway zone will start operating train services from Bengaluru city station to the newly built KIA, Devanahalli Railway halt station.

According to South Western Railway, three pairs of DEMU services would be introduced from the Bengaluru area to the Kempegowda International Airport (KIAD) Halt Station from January 4. The new railway halt station is bound to benefit thousands of commuters daily

113. Who among the following will inaugurate the Kochi-Mangaluru natural gas pipeline?

- A) Venkiah Naidu
- B) Anurag Thakur
- C) Prahlad Patel
- D) NitinGadkari
- E) NarendraModi

Answer: E

Prime Minister Narendra Modi will dedicate the Kochi - Mangaluru Natural Gas Pipeline to the nation through video conference.

The 'futuristic project', PM Modi said, will positively impact many people.

Modi said that it is a landmark day in India's quest for Urja Aatmanirbharta.

He said, this is a futuristic project that will positively impact many people.

The event marks an important milestone towards the creation of One Nation One Gas Grid.

The 450 kilometre long pipeline has been built by GAIL (India) Limited.

It has a transportation capacity of 12 Million Metric Standard Cubic Metres per day.

It will carry natural gas from the Liquefied Natural Gas (LNG) Regasification Terminal at Kochi, Kerala to Mangaluru, Karnataka, while passing through Ernakulam, Thrissur, Palakkad, Malappuram, Kozhikode, Kannur and Kasaragod districts.

The total cost of the project was about Rs.3000 crore and its construction created over 12 lakh man-days of employment.

Kerala Chief Minister Pinarayi Vijayan, Karnataka Chief Minister BS Yediyoorappa and Union Minister for Petroleum and Natural Gas Dharmendra Pradhan will participate in the inaugural function.

114. India has recently begun its _____ Scientific Expedition to Antarctica.

- A) 36th
- B) 37th

- C) 40th
- D) 39th
- E) 38th

Answer: C

India launched the 40th Scientific Expedition to Antarctica.

This Indian expedition marks four decades of the country's scientific endeavour to the southern white continent.

The 40th expedition journey will be flagged off from Goa with 43 members onboard.

The chartered ice-class vessel MV Vasily Golovnin will make this journey and will reach Antarctica in 30 days.

After leaving behind a team of 40 members, it would return to India in April.

On return, it will also bring back the winter team of the preceding trip.

115. FSSAI has slashed the limit for trans fat levels in foods to _____ per cent for 2021.

- A) 2.5
- B) 3
- C) 2
- D) 4
- E) 3.5

Answer: B

The Food Safety and Standards Authority of India (FSSAI) has capped the amount of trans fatty acids (TFA) in oils and fats to 3% for 2021 and 2% by 2022 from the current permissible limit of 5%.

This Regulation through an amendment to the Food Safety and Standards (Prohibition and Restriction on Sales) Regulations.

The revised regulation applies to edible refined oils, vanaspati (partially hydrogenated oils), margarine, bakery shortenings, and other mediums of cooking such as vegetable fat spreads and mixed fat spreads.

India first passed the TFA limit of 10% in oils and fats in 2011.

116. Which edition of the International Film Festival of India (IFFI) will open on 16th January?

- A) 47th
- B) 48th
- C) 49th
- D) 51st
- E) 52nd

Answer: D

The 51st International Film Festival of India (IFFI) will open on 16th January, with the Indian premiere of the movie 'Another Round' by Thomas Vinterberg.

The movie starring Cannes Best Actor Award winner MadsMikkelsen is among a star-studded line up of movies being showcased at IFFI. The movie is also Denmark's official entry to the Oscars.

The festival will also witness the World Premier of 'Mehrunisa'. The film by Sandeep Kumar will premier mid-fest.

117. The government of which state has set up a Tamil Academy to promote the language?

- A) Chhattisgarh
- B) Uttar Pradesh
- C) Delhi
- D) Punjab
- E) Haryana

Answer: C

Delhi Government Department of Art, Culture, and Language has set up a Tamil Academy to Promote the language and culture of the southern state of Tamil Nadu.

The Delhi government has appointed former municipal councillor and current member of Delhi Tamil Sangam N Raja as the vice-chairman of the academy.

The Department of Art, Culture and Language of the Delhi government has decided that the new academy will introduce various awards to promote and reward the good works of people in Tamil language and culture.

The government will also provide language courses through this academy.

It will also celebrate and organise cultural festivals for the people of Tamil Nadu.

118. Justice S Muralidhar has taken Oath as Chief Justice of which High Court?

- A) Punjab
- B) Madras
- C) Mumbai
- D) Haryana
- E) Odisha

Answer: E

On January 04, Justice S Muralidhar took oath as the 32nd Chief Justice of Orissa High Court. Governor of Odisha Prof. Ganeshi Lal administered the oath of office at Raj Bhawan in Bhubaneswar in a simple ceremony.

Justice S Muralidhar succeeds Justice Mohammad Rafiq as the new chief justice of the Orissa High Court.

S Muralidhar was appointed as an Additional Judge of Delhi High Court on May 29, 2006, and as Permanent Judge on August 29, 2007.

Later, he was transferred to Punjab and Haryana High Court on March 6, 2020.

119. Department for Promotion of Industry and Internal Trade is organizing _____ - a marathon of focused sector-specific webinars for promoting Quality and Productivity in Indian Industry from Jan 4 to March 2.

- A) Udyog
- B) AayatNiryat
- C) UdyogManthan
- D) UdyogUday
- E) UdyogUjjala

Answer: C

Department for Promotion of Industry and Internal Trade is organizing UdyogManthan - a marathon of focused sector-specific webinars for promoting Quality and Productivity in Indian Industry.

It got underway Jan 4 and will go on till 2nd of March.

Commerce and Industry Minister Piyush Goyal will chair the session.

The webinar series comprising 45 sessions will cover various major sectors in manufacturing and services. Each webinar will be a two-hour session involving discussions led by sectoral and industry experts in a particular sector.

Participants will include representatives from industry, testing and standardization bodies.

120. The Petroleum Minister has inaugurated the Migrant Worker Cell in which city?

- A) Chennai
- B) Delhi
- C) Chandigarh
- D) Surat
- E) Indore

Answer: D

Union Minister Dharmendra Pradhan has inaugurated a migrant worker cell of Surat Municipal Corporation (SMC) at Udhna based iLab in Surat.

Mr. Pradhan said that the migrant workers cell with linkage with the city livelihood centre will help extend all kinds of assistance and government-led benefits to them.

Migrant workers' Cell has been created by Surat Municipal Corporation for the first time in the Country under the 'National Urban Livelihood Mission Scheme'.

The city has a presence of over 15 lakh migrant workers.

He said that this cell will do a detailed mapping of migrant workers and classify them according to their skill.

This will help in connecting 'Shramshakti' to relevant industries and boost their livelihood and also ensure their dignity.

121. Who among the following has taken oath as new chief justice of J&K and Ladakh high court?

- A) Raj Gupta
- B) Pankaj Mittal
- C) Suresh Singh
- D) Naresh Mehta
- E) Anand Raj

Answer: B

On January 04, 2021, Lieutenant Governor ManojSinha administered the oath of office to Justice PankajMithal as the new chief justice of the common high court for the Union Territory of Jammu & Kashmir and Union Territory of Ladakh.

Chief justice Mithal has been appointed in view of the retirement of chief justice Gita Mittal recently.

Chief Justice Mithal was administered the oath of office by Lieutenant Governor of J&k, ManojSinha.

122. Digital channels of PrasarBharati have registered more than _____ percent growth in 2020, with Pakistan being the second highest digital audience for Doordarshan (DD) and All India Radio (AIR).

- A) 50
- B) 80
- C) 100
- D) 90

E) 70

Answer: C

Digital channels of PrasarBharati have registered more than 100 percent growth in 2020, with Pakistan being the second highest digital audience for Doordarshan (DD) and All India Radio (AIR).

The Ministry of Information and Broadcasting stated the channels across Doordarshan and Akashvani clocked over a billion digital views and over six billion digital watch minutes in the year. During 2020, Pakistan accounted for the second highest digital audience for DD and AIR content after domestic audience.

During 2020, PrasarBharati's mobile application 'NewsOnAir' added more than 2.5 million users with the platform registering over 300 million views.

PrasarBharati Archives and DD Kisan have been steady digital performers featuring in top 10.

123. US Congress passes 'MalalaYousafzai Scholarship Act' for women of which country?

- A) Turkmenistan
- B) Kazakhstan
- C) Uzbekistan
- D) Pakistan
- E) Afghanistan

Answer: D

:

The US Congress has passed the MalalaYousafzai Scholarship Act which will expand the number of scholarships available to

Pakistani women to receive higher education under a merit and needs-based programme. The bill was passed by the United States Senate by a voice vote on January 1.

The bill now heads to the White House for US President Donald Trump to sign into law.

About the bill :

The bill requires the US Agency for International Development to award at least 50 percent of scholarships under a Pakistan-based higher education scholarship programme to Pakistani women, from 2020 to 2022, across a range of academic disciplines and in accordance with existing eligibility criteria.

The bill also requires USAID to consult with and leverage investments by the Pakistani private sector and Pakistani diaspora in the United States to improve and expand access to education programmes in Pakistan.

124. A 5-day national folk dance festival will be organized in _____ by the Ministry of Culture.

- A) Delhi
- B) Indore
- C) Chennai
- D) Chandigarh
- E) Jammu

Answer: E

:

North Zone Cultural Centre, Patiala (Ministry of Culture, Govt. of India) and Jammu & Kashmir Academy of Art, Culture & Languages, Jammu is jointly organizing National Folk Dance Festival from December 26-28.

The festival is of five days and for three days it will be organised at Abhinav Theatre, Jammu. Artists from Jammu and Kashmir, Gujarat, Rajasthan, Madhya Pradesh, Odisha, Punjab, Assam, Tripura, Maharashtra, Telangana and Haryana, will participate in it.

The festival is part of our efforts to bring together tribal artists from different regions of the country. Encourage them and ensure that arts forms are showcased to the people. It's a way to preserve the great cultural traditions of India.

This Festival was inaugurated by Former Deputy CM, Kevinder Gupta, S D Singh Jamwal and senior Journalist SohailKazmi was also Present.

125. India has sent relief materials to which country for its cyclone affected people?

- A) Sri Lanka
- B) Madagascar
- C) Fiji
- D) Mauritius
- E) St. Knits and Keeves

Answer: C

India has sent over six tons of relief material to Fiji for its cyclone-affected people, reflecting its close ties with the island nation in the South Pacific.

Fiji was hit by cyclone Yasa on December 17 and 18 that caused extensive damage and destruction of critical infrastructure.

Disaster Risk Reduction and Management is an important pillar of India's Indo-Pacific Oceans' Initiative announced by Prime Minister NarendraModi in November 2019.

The Ministry of External Affairs said, India remains committed to extend full support to Fiji's

efforts to restore livelihoods of the affected communities and to build resilient infrastructure

Dear Friends, this is the Special Paid Bundle PDF Course which was made because of the Hard work of Our Experts Team. This PDF Course consists of High-Standard Questions on Reasoning, Quants, English, Current Affairs Quiz, Static GK Quiz and Banking Awareness Quiz Exactly on Exam Level. Total 40,000 Questions and Course Duration is of 50 Days for each exam. If anyone got this PDF without purchasing it, kindly buy this PDF Officially using the link given below. This will encourage us to work harder to produce high quality content for you in upcoming days.

[Get Our Special Grand Bundle PDF Course for All Upcoming Bank Exams](#)