

RRB PO Mains Memory Based Paper 2021 Based on 25th September 2021

Reasoning Ability

Yearly Platinum Package

All Bank + Insurance + Railway + SSC Exams

1 Year Validity

- ✓ 3000+ Mock Test Series
- ✓ Full-Test, Sectional tests, Topic Tests, eBooks
- ✓ Best Quality Questions Based on Real Exams
- ✓ 24*7 Access on Website and Mobile app

 **guidely**

Enroll now

Grand Bundle PDF Course 2021

Exams Covered:

**SBI Clerk | SBI PO | IBPS RRB PO |
IBPS RRB Clerk | IBPS PO | IBPS Clerk**

Seperate PDF Course for All Major Bank pre + Mains Exams

- Total No.of Ques: 40,000+
- Question in Bilingual (Eng & Hindi)
- Answers With Detailed Video Solution
- Provides you 50 days Study Planner for each exams
- Covers All Types of Questions in Each Topic
- Questions in Exact Exam Level
- All Our PDFs are Downloadable
- 100% Satisfaction Assured & It's Worthy for your money
- Download as PDF & also take Quiz with Timer

 **guidely**

Grab It Now

Reasoning Ability

Directions (1-5): Study the following information carefully and answer the below questions.

A certain number of persons are sitting in the linear row facing the north direction. Only four persons sit between F and the one who likes yellow. The one who likes Pink sits second to the right of F. Three persons sit between the one who likes Pink and K. The one who likes pink sits third from one of the ends. M sits fifth to the left of K. The number of persons sit between M and the one who likes Yellow is the same as the number of persons sit between the one who likes yellow and T. T sits second to the left of the one who likes Red. Only three persons sit between E and J. Only four persons sit between the one who likes Red and J. E sits second from the right end. Only two persons sit between E and the one who likes Gray.

1) How many persons sit in the linear row?

- a) 20
- b) 21
- c) 22
- d) 23
- e) 24

2) Which of the following statement is true?

- a) None of the statements is true
- b) More than four persons sit to the right of the one who likes gray
- c) The one who likes Pink and M are not immediate neighbors

- d) Only three persons sit between K and T
- e) The one who like gray sits immediate right of J

3) Who among the following person sits at the extreme left end?

- a) J
- b) K
- c) The one who sits third to the left of T
- d) The one who sits immediate left of F
- e) F

4) If F is related to Pink and T is related to Red in a certain way. Then who among the following is related to E?

- a) Unknown person
- b) The one who likes gray
- c) T
- d) The one who sits immediate left of K
- e) M

5) How many persons sit to the right of the one who likes red?

- a) 11
- b) 10
- c) 12
- d) 13
- e) 09

Directions (6-8) Study the following information carefully and answer the below questions

RRB PO Mains Memory Based Paper 2021 Based on 25th September 2021**Reasoning Ability**

A family consists of eight members and three married couples. No single parent has a child. P is the father of S. N is the only son of M. P is the brother-in-law of N. P does not have any siblings. N is the uncle of K. J is the mother of the S's uncle. M is the maternal grandfather of X's son. T is the sister-in-law of X and daughter-in-law of J. K and T are of the same gender. N's sister has only one son.

6) Who among the following person is the sister of S?

- a) P
- b) N
- c) T
- d) K
- e) No one

7) How is M related to J?

- a) Nephew
- b) Son
- c) Husband
- d) Brother
- e) Brother-in-law

8) Which of the following statement is true?

- a) S and N are of the same gender
- b) K is not a child of T
- c) J is the mother of X
- d) N and T are married couples
- e) All are true

Directions (9-13): Study the following information carefully and answer the below questions.

Eight Events- A, B, C, D, E, F, G, and H are held in different cities- Gwalior, Jaipur, Lucknow, Kolkata, Nagpur, Chennai, Dispur, and Mumbai on different months- January, February, March, April, May, July, August, and November of the same year. All the information is not necessarily in the same order.

Event A was held in the month which has 30 days. Only two events are held between A and the event held in Kolkata. Event H is held immediately before the event held in Kolkata. As many Events held before A as after the event held in Chennai. Event of C was held in the month which has an even number of days. Event C was held two events after the event held in Mumbai. The number of events held between C and the event held in Chennai is the same as the number of events held between A and the event held in Dispur. Event F was held immediately before G, neither of the events was held in Dispur. Event B was held immediately before the event held in Gwalior. At least one event is held after the event which held in Gwalior. Event E was held before the event held in Nagpur. No event was held between D and the event held in Lucknow.

9) Four of the five among the following are similar in such a way to form a group, which one of the following doesn't belong to the group?

- a) B-Jaipur
- b) F-Lucknow
- c) A-Mumbai
- d) Kolkata-April

RRB PO Mains Memory Based Paper 2021 Based on 25th September 2021

Reasoning Ability

e) Mumbai-Nagpur

10) If B is related to Gwalior and E is related to Nagpur in a certain way. Then who among the following is related to Mumbai?

- a) The event which held on May
- b) The event which held immediately before F
- c) The event which held immediately after E
- d) G
- e) E

11) Which of the following statement is true?

- a) No event is held after H
- b) Event E was held in Kolkata
- c) Only four events are held between A and C
- d) Event G was held on April
- e) All are true

12) Which of the following event was held immediately after the event held in Jaipur?

- a) F
- b) D
- c) E
- d) The event which held two events before C
- e) The event which held immediately after G

13) How many events are held between F and the event held in Mumbai?

- a) One
- b) Five
- c) Four
- d) Three
- e) Two

Directions (14-16): Study the following information carefully and answer the below questions

Jim and Joy are standing in point A. Jim started walking from Point A for 9m towards the west direction to reach point G then he takes right turn and walks for 11m to reach point H where he turns to the left and walks for 5m to reach point B then he turns to the right and walks for 6m to reach point C where he again turns to the right and walks for 12m to reach point K.

Joy walks from Point A for 7m towards the south direction to reach point Y then she takes a left turn and walks for 6m to reach point M where she turns to the right and walks for 9m to reach point J then she turns to the right and walks for 8m to reach point D where she again turns to the right and walks for 3m to reach point F.

14) How far and what is the direction of F with respect to K?

- a) 31m towards south
- b) 32m towards north
- c) 30m towards south
- d) 33m towards south
- e) 30m towards north

15) What is the direction of A with respect to D?

- a) South-east
- b) North-West
- c) North-East
- d) South
- e) South-west

RRB PO Mains Memory Based Paper 2021 Based on 25th September 2021

Reasoning Ability

16) Four of the following are alike in a certain way. Which of the following ones does not belong to the group?

- a) CG
- b) KA
- c) FJ
- d) GY
- e) DM

Directions (17-21): Study the following information carefully and answer the below questions.

Eight persons-A, B, C, D, E, S, T, and V are working in a company with different grade positions such as Chief Financial officer(CFO), Executive Director(ED), General Manager(GM), Deputy General Manager(DGM), Manager, Assistant Manager(AM), PO and Clerk. They like different animals- Kangaroo, Iguana, Hyena, Puma, Giraffe, Fox, Lion, and Jaguar. All the information is not necessarily in the same order.

Note: The Chief financial officer (CFO) is the highest designated post whereas Clerk is the lowest designated post.

A is junior to the one who is Assistant Manager. Only one person holds a position between A and the one who likes Puma. As many persons junior to A as senior to S. Only one person holds a position between S and the one who likes Lion. C is immediately junior to the one who likes Fox. Only three persons hold the positions between A and the one who likes Fox. The number of persons holds the positions

between S and the one who likes Fox is the same as the number of persons holds the positions between C and B. No one holds the position between B and D. E is immediately junior to the one who likes the Giraffe. V is junior to E but senior to the one who likes Iguana. Less the two persons hold the position between T and the one who likes Jaguar. V does not like Kangaroo.

17) How many persons hold the positions between B and the one who likes Giraffe?

- a) Three
- b) Two
- c) Four
- d) Five
- e) None

18) Who among the following person work as the PO?

- a) The one who likes Hyena
- b) The one who likes Puma
- c) T
- d) D
- e) B

19) As many persons junior to B as senior to _____?

- a) D
- b) S
- c) The one who likes Fox
- d) The one who works immediately senior to A
- e) The one who likes Puma

Reasoning Ability

20) Four of the five among the following are similar in such a way to form a group, which one of the following doesn't belong to the group?

- a) S-Jaguar
- b) C-Iguana
- c) E-Hyena
- d) B-Lion
- e) T-Giraffe

21) Which of the following statement is true?

- a) More than two persons are senior to D
- b) A likes Puma
- c) No one holds the position between S and D
- d) C is the Manager
- e) All the statements are true

Directions (22-24): Study the following statements and then decide which of the given conclusions logically follows from the given statements disregarding commonly known facts.

22) Statement

Only a few Colors are Paint

All Paints are Art

Some Art is Picture

Conclusion

I. All Colors being paint is a possibility

II. No Picture is Paint

- a) Only I follow
- b) Either I or II follow
- c) Only II follows
- d) Both I and II follow
- e) Neither I nor II follow

23) Statement

Only a few Portrait are sketch

All Sketchs are Picture

No Picture is Canvas

Conclusion

I. Some Portrait being Picture is a possibility

II. No Sketch is Canvas

- a) Only I follow
- b) Either I or II follow
- c) Only II follows
- d) Both I and II follow
- e) Neither I nor II follow

24) Statement

Only a few Drinks are Cool

All Cool are Hot

All Drinks are Flavour

Conclusion

I. Some Drink is not Hot

II. All Flavour can never be Cool

- a) Only I follow
- b) Either I or II follow
- c) Only II follows
- d) Both I and II follow
- e) Neither I nor II follow

Directions (25-29): Study the following information carefully and answer the below questions.

Eight persons- J, K, L, M, N, O, P, and Q are living in the four-storey building. They like different flowers- Sunflower, Lilly, Orchid, Tulip,

RRB PO Mains Memory Based Paper 2021 Based on 25th September 2021

Reasoning Ability

Marigold, Daffodil, Crossandra, and Rose but not necessarily in the same order.

Note:

i. Each floor has two flats viz., flat X and flat Y.

No two people live in the same flat. Flat X is exactly to the west of Flat Y.

ii. Flat X of floor 2 is immediately above flat X of Floor 1 whereas flat Y of floor 2 is immediately above flat Y of floor 1 and so on.

iii. The floors are numbered 1 to 4 from the bottom to top.

P lives on an even number floor. P lives immediately below the flat of the one who likes Lily. N lives west of the one who likes Rose. P does not like Rose. The one who likes Rose lives immediately above the flat of the one who likes Daffodil. Only one floor is between N and the one who likes Crossandra. The one who likes Crossandra lives immediately below J in different flats. The one who likes Crossandra lives three floors below the flat of K. K lives west of the one who likes Tulip. Q lives adjacent floor of the one who likes Orchid. At least one floor is there above the floor of the one who likes Orchid. Q and K do not live in the same type of flat. Neither Q nor L likes Rose. L lives below the one who likes Sunflower. Only one floor is between the one who likes Marigold and M.

25) Who among the following person is living on floor 3 of Flat Y?

- a) The one who likes Tulip
- b) K

- c) The one who lives on the same floor of L
- d) The one who likes Rose
- e) P

26) Which of the following statement is true?

- a) N and M lives on a different floor
- b) Q likes Tulip
- c) K and N lives on different type of flats
- d) No one lives below J
- e) L likes Crossandra

27) On which of the following floor and flat does M live?

- a) Floor 2 Flat Y
- b) Floor 3 Flat X
- c) Floor 3 Flat Y
- d) Floor 2 Flat X
- e) Floor 1 Flat Y

28) Four of the five among the following are similar in such a way to form a group, which one of the following doesn't belong to the group?

- a) K-Tulip
- b) N-Rose
- c) Lily- J
- d) L-Marigold
- e) P-Daffodil

29) Which of the following flower is liked by P?

- a) Tulip
- b) Orchid
- c) Sunflower
- d) Marigold
- e) Crossandra

Reasoning Ability

Directions (30-32): Each of the questions below consists of a question and two statements numbered I and II given below it. You have to decide whether the data provided in the statements are sufficient to answer the question:

30) Six persons- A, B, C, D, E, and F are sitting on the circular table faces the center but not necessarily in the same order. Who sits third to the right of F?

Statement I: A sits immediate left of F. Only one person sits between F and E. D sits immediate right of B.

Statement II: D sits second to the left of F. Only one person sits between F and E. B sits second to the right of C. A sits exactly between D and F.

- a) Only Statement I alone is sufficient
- b) Only Statement II alone is sufficient
- c) Either statement I or statement II is sufficient
- d) Neither statement I nor statement II is sufficient
- e) Both statement I and statement II together are sufficient

31) Six persons- L, M, N, O, P, and Q are sitting in the linear row facing the north direction but not necessarily in the same order. Who among the following person sits second from the left end?

Statement I: P sits second to the left of the one who sits third to the right of M. Only two persons sit between P and Q. Q does not sit at the end of the row.

Statement II: P sits third to the right of Q. Only three persons sit between Q and M. M does not sit second from the right end.

- a) Only Statement I alone is sufficient
- b) Only Statement II alone is sufficient
- c) Either statement I or statement II is sufficient
- d) Neither statement I nor statement II is sufficient
- e) both statement I and statement II together are sufficient

32) What is the code for "Piece tone hymn" in the given language?

Statement I: In a code language, "Piece rap tone folk" is coded as "ad vn mt lq", "Rock rap folk music" is coded as "ct mt lq sm", "Piece tone jazz sing" is coded as "ad vn jt ni".

Statement II: In a code language, "Rock melody music sing" is coded as "ct it sm ni", "Piece sing soul hymn" is coded as "ad ni uv qj", "Rock tone tune hymn" is coded as "ct vn zm qj"

- a) Only Statement I alone is sufficient
- b) Only Statement II alone is sufficient
- c) Either statement I or statement II is sufficient
- d) Neither statement I nor statement II is sufficient
- e) Both statement I and statement II together are sufficient

33) If "1" is added to the odd digits and "2" is subtracted from the even digits of the given numbers then add all the digits within the

number thus formed, then which of the following number yields resultant as the second-highest?

- a) 25863745
- b) 53864812
- c) 68453617
- d) 18367824
- e) 57836182

34) If the vowels of the following words are arranged first followed by the consonants as per the alphabetical order and the vowels are changed to the next letter and the consonants are changed to the previous letter in the alphabetical series, then which will be the fourth letter from the right end of each newly formed word in the same order?

I. FAMOUS

II. ULTIMATE

III. UNIFORM

- a) NKL
- b) PVE
- c) EKL
- d) VKE
- e) ELE

35) If the fourth letter from the right end of each word is taken to form a meaningful word, then which of the following can't form a meaningful word?

- a) Agenda, Beauty, Budget, Eighth
- b) Handed, Branch, Debate, Taking
- c) Either, Dealer, Closed, Tagging
- d) Corner, Create, Lawyer, Riding

e) Silver, Submit, Vision, Winter

36) Statement: At an enormous research cost, a leading chemical company has developed a manufacturing process for converting wood fibers into a plastic. According to the company, this new plastic can be used for, among other things, the hulls of small sailboats. But what does the company think sailboat hulls used to be made of? Surely the mania for high technology can scarcely go further than this.

The author's conclusion of the manufacturing process described in the statement is based primarily on the fact that?

- a) plastic is unlikely to be durable enough for high-quality sailboat hulls
- b) The research costs of developing the process outweigh any savings possible from the use of the plastic
- c) A small sailboat is not normally regarded as a high-tech product
- d) Hulls for small sailboats can be made from wood without converting it into plastic
- e) None of the above

Directions (37-39): Study the following information carefully and answer the question given below:

In one experiment in a study, 169 college students (65 per cent female, 88 per cent white) read a mock newspaper article describing a fictional mass shooting by an 18-year-old male youth who was described as an avid fan of

RRB PO Mains Memory Based Paper 2021 Based on 25th September 2021

Reasoning Ability

violent video games. Half of the participants read an article featuring a small mugshot of a white shooter while the other half saw a mugshot of an African-American shooter. In their responses to a questionnaire, participants who read the article with the photo of a white shooter were significantly more likely to blame video games as a factor in causing the teen to commit the school shooting than participants who saw an African-American shooter.

According to the study, participants who did not play video games also were more likely to blame violent video games for school shootings

37) Which of the following can be *inferred* from the facts given in the paragraph above?

- a) The people who don't play video games will always vote against the ones playing them
- b) The debate over video games promoting violence has yet another set of supporters this time
- c) Video games are essential for developing the intellect of an individual
- d) The participants of the survey were well acquainted with all types of video games
- e) The results of the experiment were biased against the non-players

38) What can be a probable *Course Of Action* so that the people stop blaming just the white shooter in video games?

- a) Video games showcasing white shooters should be banned

- b) Video game makers should promote the African-American shooters to share the blame
- c) Parents should train their children in terms of being able to choose what is morally wrong as it is not just the games that are responsible
- d) Schools should rusticate the students bringing guns to the schools
- e) None of the above

39) Which of the following can be *assumed* about the behavior of the participants of the survey?

- a) The participants have personified the actual 18-year old shooter with the poster on their respective articles
- b) The participants who saw the mugshot of the African-American shooter were biased
- c) The participants who did not play games did not know much about it
- d) All the participants read the article with 100% attention
- e) Both (c) and (d)

40) Statement: Indian carriers have announced a fresh slew of discounted ticket fares to bolster demand in the lean travel season.

Assumptions:

- (i) Indians tend to book flights when they find good deals and huge discounts
 - (ii) Discounted tickets will urge the people to plan their travels
- a) None can be assumed
 - b) Only I can be assumed

RRB PO Mains Memory Based Paper 2021 Based on 25th September 2021

Reasoning Ability

- c) Either I or II can be assumed
- d) Both I and II can be assumed
- e) Only II can be assumed

Answer With Explanation

Directions (1-5):

- 1) Answer: C
- 2) Answer: E
- 3) Answer: E
- 4) Answer: A
- 5) Answer: B

Final Arrangement

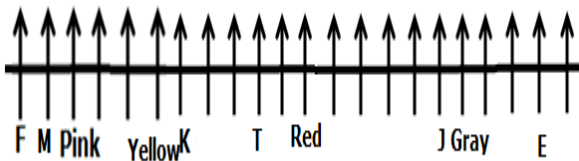

We have,

- Only four persons sit between F and the one who likes yellow.
- The one who likes Pink sits second to the right of F.

From the above condition, there are two possibilities.

Case1

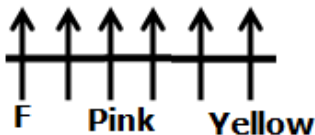

Case2



Again we have,

- Three persons sit between the one who likes Pink and K.
- The one who likes pink sits third from one of the ends.
- M sits fifth to the left of K.

Case1

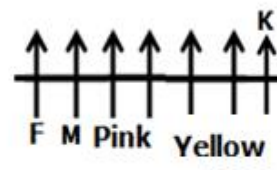

Case2

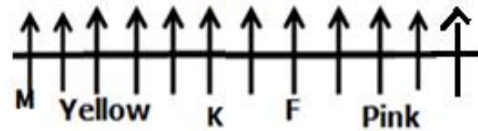

Again we have,

- The number of persons sit between M and the one who likes Yellow is the same as the number of persons sit between the one who likes yellow and T.
- T sits second to the left of the one who likes Red.

RRB PO Mains Memory Based Paper 2021 Based on 25th September 2021

Reasoning Ability

Case1

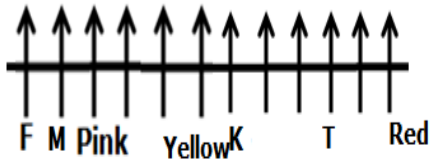

Case2

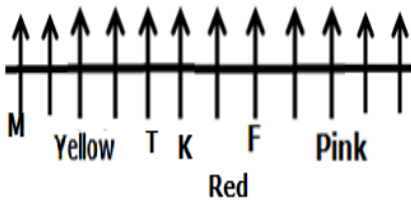

Again we have,

- Only three persons sit between E and J.
- Only four persons sit between the one who likes Red and J.
- E sits second from the right end.
- Only two persons sit between E and the one who likes Gray.

From the above condition, case2 gets eliminated. Case1 shows the final arrangement.

Case1

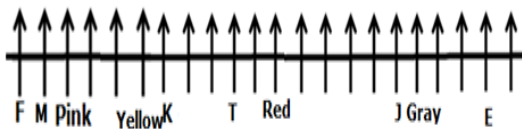

~~Case2~~

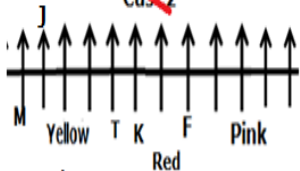

Directions (6-8)

- 6) Answer: D
- 7) Answer: C
- 8) Answer: E

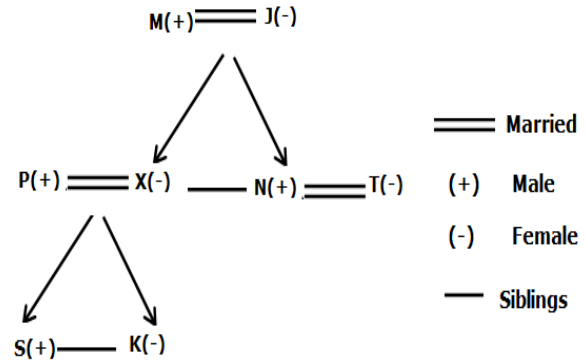

Directions (9-13):

- 9) Answer: D
- 10) Answer: A
- 11) Answer: B
- 12) Answer: E
- 13) Answer: D

Final Arrangement

Months	Events	City
January	B	Dispur
February	F	Gwalior
March	G	Jaipur
April	A	Lucknow
May	D	Chennai
July	H	Mumbai
August	E	Kolkata
November	C	Nagpur

We have,

- Event of A was held in the month which has 30 days.
- Only two events are held between A and the event held in Kolkata.
- Event H was held immediately before the event held in Kolkata.

RRB PO Mains Memory Based Paper 2021 Based on 25th September 2021

Reasoning Ability

From the above condition, there are two possibilities.

	Case1		Case2	
Months	Events	City	Events	City
January				
February				
March				
April	A		H	
May				Kolkata
July	H			
August		Kolkata		
November			A	

Again we have,

- As many Events held before A as after the event held in Chennai.
- Event of C was held in the month which has an even number of days.
- Event C was held two events after the event held in Mumbai.

From the above condition, case2 gets eliminated.

	Case1		Case2	
Months	Events	City	Events	City
January				Chennai
February				
March				
April	A		H	
May		Chennai		Kolkata
July	H	Mumbai		
August		Kolkata		
November	C		A	

Again we have,

- The number of events held between C and the event held in Chennai is the same as the number of events held between A and the event held in Dispur.
- Event F was held immediately before G, neither of the events was held in Dispur.
- Event B was held immediately before the event held in Gwalior. At least one event is held after the event which held in Gwalior.

Months	Events	City
January	B	Dispur
February	F	Gwalior
March	G	
April	A	
May		Chennai
July	H	Mumbai
August		Kolkata
November	C	

RRB PO Mains Memory Based Paper 2021 Based on 25th September 2021

Reasoning Ability

Again we have,

- Event E was held before the event held in Nagpur.
- No event was held between D and the event held in Lucknow.

Months	Events	City
January	B	Dispur
February	F	Gwalior
March	G	Jaipur
April	A	Lucknow
May	D	Chennai
July	H	Mumbai
August	E	Kolkata
November	C	Nagpur

Directions (14-16):

14) Answer: C

15) Answer: C

16) Answer: E

Final Arrangement

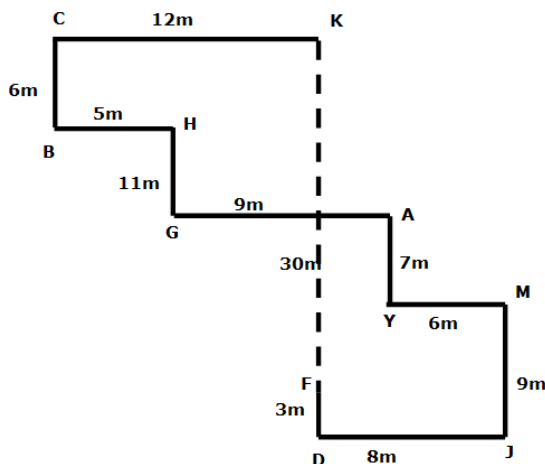

Directions (17-21):

17) Answer: B

18) Answer: A

19) Answer: D

20) Answer: B

21) Answer: D

Final Arrangement

Positions	Person	Animals
CFO	S	Kangaroo
ED	B	Jaguar
GM	D	Lion
DGM	T	Fox
Manager	C	Giraffe
AM	E	Puma
PO	V	Hyena
Clerk	A	Iguana

We have,

- A is junior to the one who is Assistant Manager.
- Only one person holds a position between A and the one who likes Puma.

From the above condition, there are two possibilities.

RRB PO Mains Memory Based Paper 2021 Based on 25th September 2021

Reasoning Ability

Positions	Case1		Case2	
	Person	Animals	Person	Animals
CFO				
ED				
GM				
DGM				
Manager		Puma		
AM				Puma
PO	A			
Clerk			A	

Again we have,

- As many persons junior to A as senior to S.
- Only one person holds a position between S and the one who likes Lion.
- C is immediately junior to the one who likes Fox.
- Only three persons hold the positions between A and the one who likes Fox.

Positions	Case1		Case2	
	Person	Animals	Person	Animals
CFO			S	
ED	S			
GM		Fox		Lion
DGM	C	Lion		Fox
Manager		Puma	C	
AM				Puma
PO	A			
Clerk			A	

- The number of persons holds the positions between S and the one who likes Fox is the same as the number of persons holds positions between C and B.
- No one holds the position between B and D.
- E is immediately junior to the one who likes the Giraffe.
- V is junior to E but senior to the one who likes Iguana.

From the above condition, case1 gets eliminated.

Positions	Case1		Case2	
	Person	Animals	Person	Animals
CFO			S	
ED	S		B	
GM		Fox	D	Lion
DGM	C	Lion		Fox
Manager	B	Puma	C	Giraffe
AM	D		E	Puma
PO	A		V	
Clerk			A	Iguana

Again we have,

- Less the two persons hold the position between T and the one who likes Jaguar.
- V does not like Kangaroo.

From the above condition, case2 shows the final arrangement.

RRB PO Mains Memory Based Paper 2021 Based on 25th September 2021

Reasoning Ability

Case2		
Positions	Person	Animals
CFO	S	Kangaroo
ED	B	Jaguar
GM	D	Lion
DGM	T	Fox
Manager	C	Giraffe
AM	E	Puma
PO	V	Hyena
Clerk	A	Iguana

Directions (22-24):

22) Answer: E

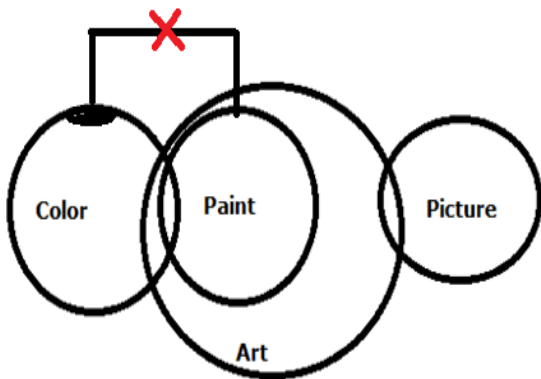

Neither I nor II follow

23) Answer: C

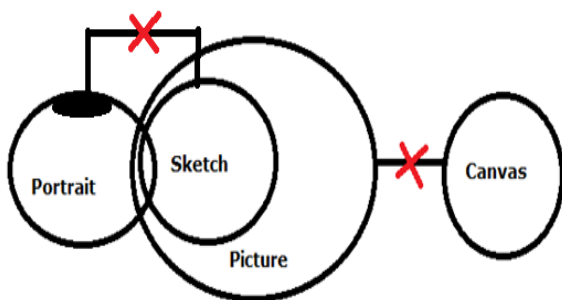

Only II follows

24) Answer: C

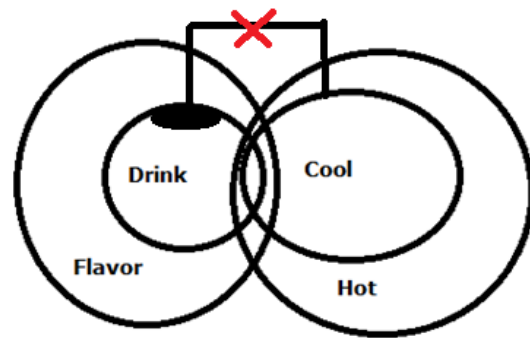

Only II follows

Directions (25-29):

25) Answer: D

26) Answer: E

27) Answer: C

28) Answer: C

29) Answer: B

Final Arrangement

Floor	Flat X	Flat Y
4	K, Sunflower	O, Tulip
3	N, Lily	M, Rose
2	P, Orchid	J, Daffodil
1	L, Crossandra	Q, Marigold

We have,

- P lives on an even number floor.
- P lives immediately below the flat of the one who likes Lily.
- N lives west of the one who likes Rose.
- P does not like Rose.
- The one who likes Rose lives immediately above the flat of the one who likes Daffodil.

RRB PO Mains Memory Based Paper 2021 Based on 25th September 2021

Reasoning Ability

From the above condition, there are two possibilities.

	Case1		Case2		Case1a	
Floor	Flat X	Flat Y	Flat X	Flat Y	Flat X	Flat Y
4			N	Rose	N	Rose
3	N, Lily	Rose		Lily	Lily	Daffodil
2	P	Daffodil		P	P	
1						

Again we have,

- Only one floor is between N and the one who likes Crossandra.
- The one who likes Crossandra lives immediately below J in different flats.
- The one who likes Crossandra lives three floors below the flat of K.
- K lives west of the one who likes Tulip.

From the above condition, case1a gets eliminated.

	Case1		Case1a	
Floor	Flat X	Flat Y	Flat X	Flat Y
4	K	Tulip	N	Rose
3	N, Lily	Rose	Lily	Daffodil
2	P	J, Daffodil	P	
1	Crossandra			

Again we have,

- Q lives adjacent floor of the one who likes Orchid.
- At least one floor is above the floor of the one who likes Orchid.

- Q and K do not live in the same type of flat.
- Neither Q nor L likes Rose.
- L lives below the one who likes Sunflower.
- Only one floor is between the one who likes Marigold and M.

	Case1	
Floor	Flat X	Flat Y
4	K, Sunflower	O, Tulip
3	N, Lily	M, Rose
2	P, Orchid	J, Daffodil
1	L, Crossandra	Q, Marigold

30) Answer: B

From statement1, we can't get the answer

Statement 2

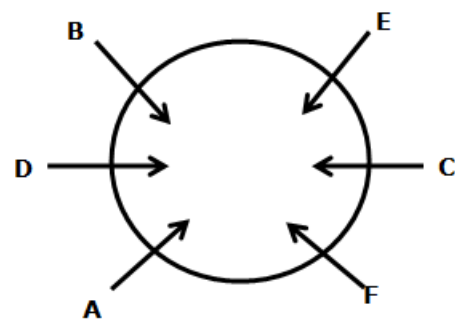

From statement2, we can get the answer

31) Answer: C

Statement 1



RRB PO Mains Memory Based Paper 2021 Based on 25th September 2021

Reasoning Ability

From statement 1, we can get the answer

Statement 2



From the statement, we can get the answer.

32) Answer: E

Statement 1

Word	Code
Piece/Tone	Ad/vn

Statement 2

Words	Codes
Piece/soul	Ad/uv
Hymn	Qj
Tone/Tune	Vn/zm

From both statement 1 and statement 2

Words	Codes
Piece	Ad
Tone	Vn
Hymn	Qj

33) Answer: D

a) 25863745 → 06644826 = 36

b) 53864812 → 64642620 = 30

c) 68453617 → 46264428 = 36

d) 18367824 → 26448602 = 32

e) 57836182 → 68644260 = 36

34) Answer: D

I. FAMOUS → AOUFMS → BPVELR

II. ULTIMATE → AEIULMTT → BFJVKLSS

III. UNIFORM → IOUFMNR → JPVELMQ

35) Answer: E

a) Agenda, Beauty, Budget,

Eighth → eadg → Aged

b) Handed, Branch, Debate,

Taking → nabk → Bank

c) Either, Dealer, Closed, Tagging → taog → Goat

d) Corner, Create, Lawyer, Riding → rewd → Drew

e) **Silver, Submit, Vision, Winter → lbsn**

36) Answer: D

The author is trying to point out the redundancy of the so-called new invention/development.

Hulls are made of wood. The new invention involves a method, which converts wood into some kind of plastic, which is then used to make hulls of ships. The new invention is basically lengthening and complicating the process. Thus, D is correct.

37) Answer: B

Reasoning Ability

Out of all the given options, only option (b) reaches close to the idea of the study being mentioned in the paragraphs above.

Option (a) can be true but it cannot be inferred from the paragraph

Options (c) and (d) cannot be deduced from the context

Option (e) could be close had it been biased in favor of the non players and not against them.

38) Answer: C

Does option (a) solve or lessen the problem?
No! As if not games then there could be other means too

Does option (b) solve or lessen the problem?
Not at all; in fact it would aggravate the issue crying racism

Does option (d) solve the issue? Definitely not; as banning them would make them more aggressive

Option (c) may not completely solve the problem but at least lessen it a bit. So out of the given choices, (c) should be correct.

39) Answer: A

Option (a) if assumed will make us infer the facts given in the paragraph about the study that has been mentioned.

Other options if assumed won't resonate with the context of the passage.

Hence, option (a) is the correct answer

40) Answer: D

The airlines have already discounted the fares and as per the statement this step has been taken in order to increase the demand.

If they assume I, they would take the step in the statement

If they assume II, they would take the step in the statement

Hence, both I and II are good to be called as assumptions.

RRB PO Mains Memory Based Paper 2021 Based on 25th September 2021

Reasoning Ability

Yearly Platinum Package

All Bank + Insurance + Railway + SSC Exams

1 Year Validity

- ✓ 3000+ Mock Test Series
- ✓ Full-Test, Sectional tests, Topic Tests, eBooks
- ✓ Best Quality Questions Based on Real Exams
- ✓ 24*7 Access on Website and Mobile app

 **guidely**

Enroll now

Grand Bundle PDF Course 2021

Exams Covered:

SBI Clerk | SBI PO | IBPS RRB PO |
IBPS RRB Clerk | IBPS PO | IBPS Clerk

Seperate PDF Course for All Major Bank pre + Mains Exams

- Total No.of Ques: 40,000+
- Question in Bilingual (Eng & Hindi)
- Answers With Detailed Video Solution
- Provides you 50 days Study Planner for each exams
- Covers All Types of Questions in Each Topic
- Questions in Exact Exam Level
- All Our PDFs are Downloadable
- 100% Satisfaction Assured & It's Worthy for your money
- Download as PDF & also take Quiz with Timer

 **guidely**

Grab It Now